

2020
2021



MEASURING INSTRUMENTS

CATALOGUE NO. 103



QUALITY | INNOVATION | SERVICE | VALUE



The products with this mark are INSIZE PLUS brand, otherwise the products are INSIZE brand.

←INSIZE→ is our standard quality and made in China

←INSIZE PLUS→ is our premium quality and made in Germany or Italy



The products with this mark are supplied with manufacturer inspection certificate.

←INSIZE→ Inspection Certificate			
Product name	Digital Caliper	Traceable to	USA NIST No.821279484-10
Code No.	1108-150		Germany DKD No.D-K-15190-01-00
Measuring range	0-150mm / 0-6"	Inspector	<i>David</i>
Resolution	0.01mm / 0.0005"	Judgement	Passed
Serial No.	0910120004		
Standard temperature	20°C / 68°F		

Measuring Length	Permissible Error	Unit: inch		Measuring Length	Permissible Error	Unit: mm	
		External	Internal			External	Internal
0.4 DIA	+0.0005 -0.0010	/	0.0005	Φ10	+0.01 -0.02	/	0.01
2	±0.0010	-0.0005	/	50	±0.02	-0.01	/
4		-0.0005	/	100		-0.01	/
6		-0.0010	/	150		-0.02	/
8	±0.0015	/	/	200	±0.03	/	/
10		/	/	250		/	/
12		/	/	300		/	/



Please scan QR code to watch the videos of products.

We reserve the right to change or modify the design and specification of products in this catalogue without prior notice.

Copyright © INSIZE CO., LTD. All Rights Reserved.
INSIZE is the registered trademark of INSIZE CO., LTD.



PRODUCT INDEX

1 DATA OUTPUT AND SOFTWARE PAGE 1-6



DATA MANAGEMENT SOFTWARE
DATA OUTPUT CABLE

2 CALIPER PAGE 7-34



DIGITAL CALIPER
DIAL CALIPER
VERNIER CALIPER

4 HEIGHT GAGE PAGE 45-48



HIGH PRECISION HEIGHT GAGE
DIGITAL HEIGHT GAGE
MINI DIGITAL HEIGHT GAGE

5 MICROMETER PAGE 49-80



OUTSIDE MICROMETER
MICROMETER HEAD
MICROMETER GRINDING MACHINE

7 INDICATOR PAGE 109-145



DIGITAL INDICATOR
DIAL TEST INDICATOR
DIAL GAGE TESTER
MAGNETIC STAND
DIAL INDICATOR STAND
BENCH CENTER

9 PAGE 157-179



GAGE BLOCK
CHECK MASTER
ANGLE GAGE BLOCK
PIN GAGE
SETTING RING
THREAD RING GAGE
THREAD PLUG GAGE
STEEL BALL

3 DEPTH GAGE PAGE 34-44



DEPTH GAGE
DIAL DEPTH GAGE
DEPTH MICROMETER

6 BORE AND SHAFT DIAMETER PAGE 81-109



PISTOL GRIP THREE POINTS BORE GAGE
THREE POINTS INTERNAL MICROMETER
INSIDE MICROMETER
TUBULAR INSIDE MICROMETER
BORE PLUG GAGE
SPLIT TYPE DIAL BORE GAGE
BORE GAGE
INTERNAL CHAMFER GAGE
TELESCOPING GAGE SET
DIGITAL RADIUS GAGE
CIRCUMFERENCE TAPE

8 PAGE 146-156



INTERNAL/EXTERNAL CALIPER GAGE
DIGITAL THICKNESS GAGE
DIAL SNAP GAGE
ADJUSTABLE SNAP GAGE
DIGITAL SNAP GAGE
CRANKSHAFT TESTER

10 ANGLE AND STRAIGHTNESS PAGE 180-190



DIGITAL PROTRACTOR
UNIVERSAL PROTRACTOR
PERPENDICULARITY TESTER
GRANITE SQUARE
SQUARE
STRAIGHT EDGE

PRODUCT INDEX

11

PAGE 191-217



FEELER GAGE
PITCH GAGE
RADIUS GAGE
DIGITAL CHAMFER GAGE
CHAMFER HEIGHT GAGE
DIGITAL TAPER SLOT GAGE
TAPER GAGE
TAPER BORE GAGE
WELDING GAGE
INSIDE/OUTSIDE CALIPER
MEASURING TAPE
MEASURING WHEEL
STEEL RULE
COMBINATION SQUARE SET
SCRIBING CALIPER
SCRIBER
MEASURING TOOL SET

12

PAGE 218-238



GRANITE SURFACE PLATE
V-BLOCK SET
PARALLEL SET
ANGLE PLATE SET
RIGHT ANGLE PLATE
SINE BAR
PRECISION SINE VISE
PRECISION VISE
CENTERING INDICATOR
XY-AXIS STAGE
EDGE FINDER
ZERO SETTER

13

PAGE 239-245



DIGITAL SCALE
LINEAR SCALE
LINEAR GAGE

14

PAGE 246-250



CMM
JIG SET FOR CMM
SURFACE PROFILE MEASURING MACHINE

15

PAGE 251



LASER SCAN MICROMETER

16

PAGE 252-263



VISION MEASURING SYSTEM
TOOL PRESETTER
PROFILE PROJECTOR

17

MICROSCOPE

PAGE 264-295



TOOLMAKER MICROSCOPE
DIGITAL MICROSCOPE
STEREO MICROSCOPE
DIGITAL CAMERA

18

PAGE 295-300



TABLE MAGNIFIER
MAGNIFIER
TELESCOPING INSPECTION MIRROR
TELESCOPING MAGNETIC PICK-UP

19

BORESCOPE

PAGE 300-309



VIDEOSCOPE
RIGID BORESCOPE

PRODUCT INDEX

20 ROUGHNESS TESTER PAGE 310-316



ROUGHNESS TESTER
SURFACE ROUGHNESS SPECIMEN

22 LEVEL PAGE 333-339



DIGITAL LEVEL AND SLOPE METER
BLOCK LEVEL
CROSS-LINE LASER LEVEL

23 HARDNESS TESTER PAGE 340-366



ROCKWELL HARDNESS TESTER
PORTABLE LEEB HARDNESS TESTER
SHORE DUROMETER

24 FORCE GAGE PAGE 367-369



FORCE GAGE
DIAL TENSION GAGE

25 TORQUE TESTER TORQUE WRENCH PAGE 369-377



DIGITAL TORQUE TESTER
BOTTLE CAP TORQUE TESTER
DIGITAL TORQUE SCREWDRIVER
DIGITAL TORQUE WRENCH
TORQUE MULTIPLIER

21 PORTABLE INSTRUMENT PAGE 317-333



COATING THICKNESS GAGE
CROSS CUT ADHESION TESTER
DIGITAL SURFACE PROFILE GAGE
WET FILM GAGE
ULTRASONIC THICKNESS GAGE
LASER DISTANCE METER
INFRARED THERMOMETER
INFRARED THERMAL CAMERA
DIGITAL ANEMOMETER
DIGITAL MOISTURE METER
DIGITAL SOUND LEVEL METER
DIGITAL TACHOMETER
VIBRATION PEN
DIGITAL MULTIMETER
AC DIGITAL CLAMP METER
GLOSS METER
SPECTROPHOTOMETER
TACHOMETER/STROBOSCOPE
PORTABLE REFRACTOMETER
STROKE COUNTER

26 SCALE PAGE 378-383



WEIGHING SCALE
CRANE SCALE
PLATFORM SCALE
FLOOR SCALE
WEIGHT

27 PAGE 384-385



CUTTING MACHINE
MOUNTING PRESS
GRINDER AND POLISHER

1 DATA CAPTURE SOFTWARE CODE 7318



capture data from serial port



capture data from screen



capture data from files

Capture Data From Serial Port

- For measuring instruments with serial port
- Capture data from serial port of measuring instruments, converted to keyboard format, data can be transmitted to EXCEL, WORD etc. and any softwares which receive keyboard signal

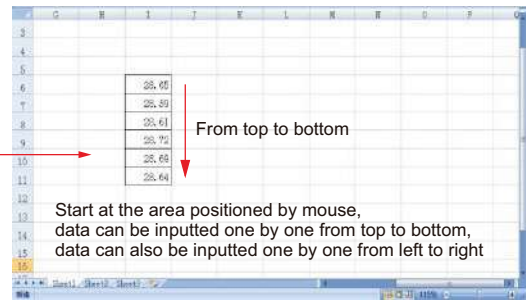

Transmit to EXCEL

Capture Data From Screen

- Capture data from the specified area of computer screen, converted to keyboard format, data can be transmitted to EXCEL, WORD etc. and any softwares which receive keyboard signal

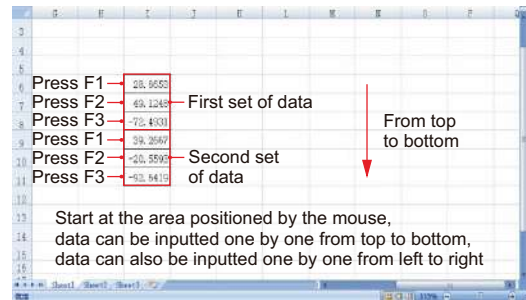
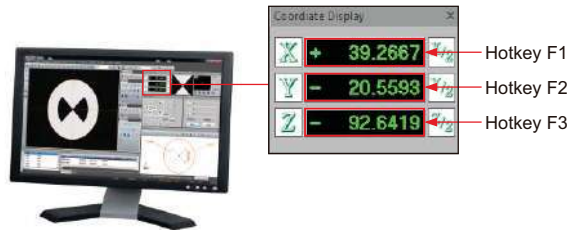

Transmit to EXCEL

Capture Data From Files

- Capture data from files (TXT, CSV etc) generated by software of instruments (CMM, etc.), extract measuring data, data can be transmitted to EXCEL

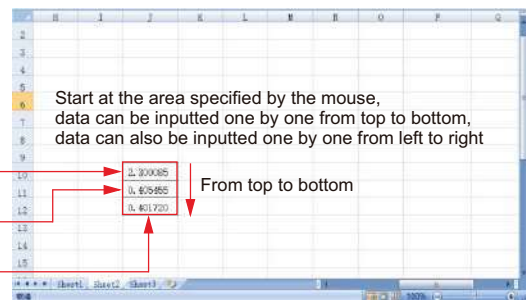
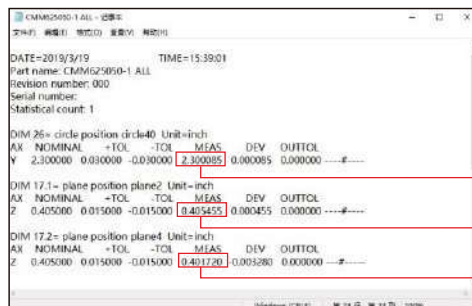

Every time the data file of the instrument is updated, the software captures data automatically and transmits to EXCEL

MEASURING DATA MANAGEMENT SOFTWARE CODE 7316-10

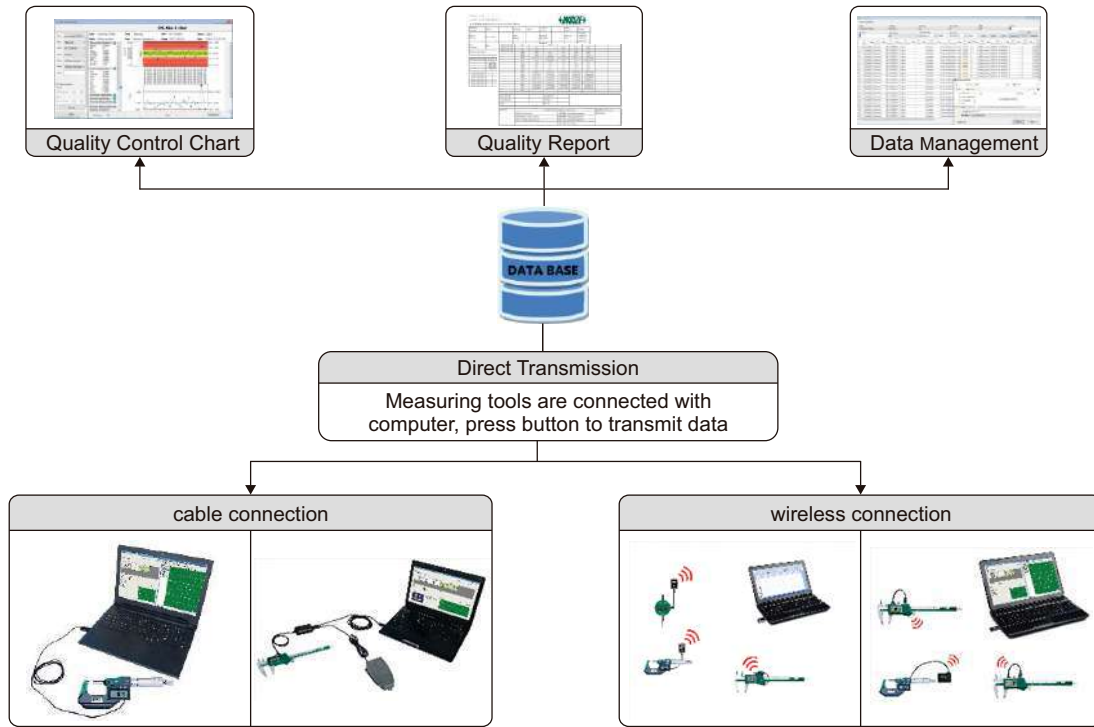

Direct Transmission

- Transmit data through cables or wireless systems

Data Management

- Measuring data are stored in database

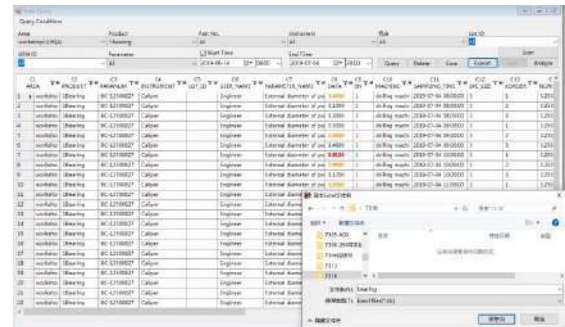
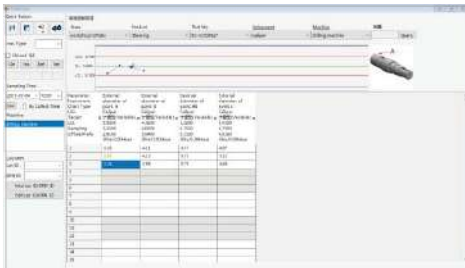

Quality Control Chart

- Analyze the tendency of data, make production adjustment in advance

Quality Report

- Generate different EXCEL reports according to requirements

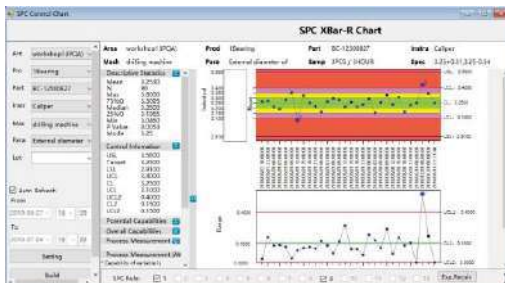

1 WIRELESS DATA TRANSFER SYSTEM

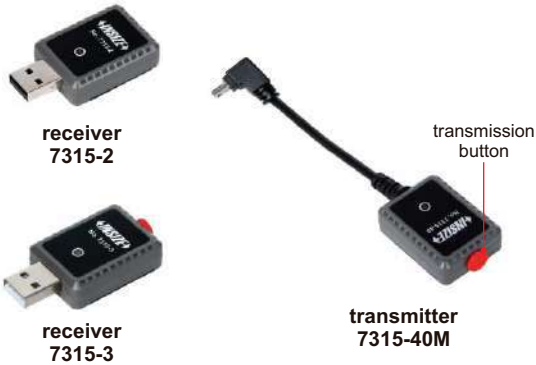

- Transmission distance is 10 meter
- Press the button to transmit data
- 7315-2 is supplied with EXCEL directional input software, each gage is only displayed in the specified area

7315-3 application (single channel)



7315-2 application (multichannel)

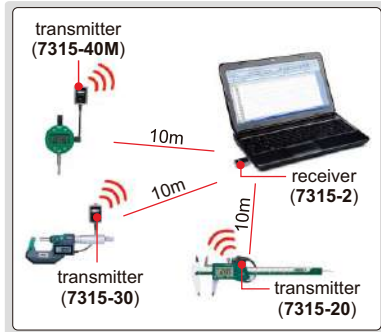

Excel directional input software (included in 7315-2), application example 1

Set the display area of caliper at B4-B9, the readings of caliper are displayed at B4, B5...B9. Set the display area of micrometer at C4-C9, the readings of micrometer are displayed at C4, C5... C9. Set the display area of height gage at D4-D9, the readings of height gage are displayed at D4, D5... D9.

Project	Length	Width	Height
Dimension and Tolerance	50±0.05	24±0.01	10±0.05/-0.06
Measuring tool	Caliper	Micrometer	Height gage
1	50.02	24.004	9.98
2	50.01	24.010	19.01
3	49.99	23.990	10.02
4	50.00	23.996	9.99
5	50.04	24.000	10.01

Serial of workpieces The next data display area is indicated in green



Excel directional input software (included in 7315-2), application example 2

Set the display area of micrometer at B4-C9, data input is from the left to the right, the readings of micrometer are displayed at B4, C4, B5... B9, C9. Set the display area of caliper at D4-D9, the readings of caliper are displayed at D4, D5... D9. Set the display area of depth gage at E4-E9, the readings of depth gage are displayed at E4, E5... E9.

Project	External diameter1	External diameter2	Length	Depth
Dimension and Tolerance	Φ21±0.01/-0.02	Φ21±0.01/-0.02	50±0.04	28±0.05
Measuring tool	Micrometer	Micrometer	Caliper	Depth gage
1	23.010	21.008	49.98	28.01
2	23.010	21.000	49.98	27.98
3	22.999	21.000	50	28
4	23.007	20.998	50	28
5	23.000	20.985	50.01	28.01
	23.008	21.000	50.01	28.01

Serial of workpieces The next data display area is indicated in green

Code	Description	Plug to product	Remark
7315-2	multichannel receiver		<ul style="list-style-type: none"> ■ Connected with maximum 8 transmitters, each of them has unique identification code. ■ Text format virtual com port, converted to keyboard format with supplied software (data can be transmitted to EXCEL, WORD etc. and any software which receives keyboard signal) ■ Using EXCEL directional input software, the measurement data of different measuring tools can be transmitted to the specified area in the sheet.
7315-3	single channel receiver		<ul style="list-style-type: none"> ■ Connected with 1 transmitter only, transmitter can be changed as needed. ■ No need to install drivers and softwares. ■ Keyboard format (data can be transmitted to EXCEL, WORD etc. and any softwares which receives keyboard signal)
7315-20	transmitter		for digital calipers for digital depth gages for 1156 series digital height gages
7315-30	transmitter		for digital micrometers for digital three points internal micrometers
7315-40M	transmitter		for digital indicators
7315-50M	transmitter		for digital thickness gages for digital internal/external caliper gages for digital protractors

DATA OUTPUT CABLES (KEYBOARD FORMAT)

- Data can be transmitted as keyboard signal to Excel, Word, txt and other files
- Suitable for any softwares which can receive keyboard signal
- There is no need to install drivers and softwares
- Optional accessory: foot switch (code: 7304-2), hub (code: 7302-HUB, 7302-HUB7)



7302-SPC5A

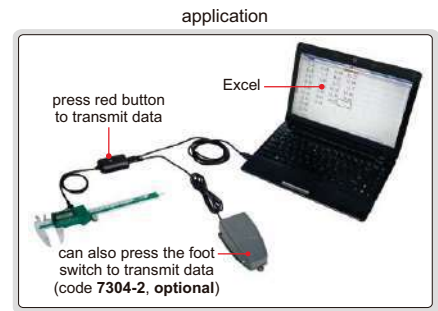

SEPARATED BUTTON

Code	Description	Plug type to product	Socket type on product	Plug type to computer	Applicable products
7302-SPC5A	cable for digital calipers (length 2.5m)				for digital calipers
7302-SPC5C					for digital depth gages
7302-SPC6	cable for digital micrometers (length 2.5m)				for digital micrometers
7302-SPC3AM	cable for digital indicators (length 2.5m)				for digital indicators
7302-SPC3BM					for digital thickness gages



7302-SPC10

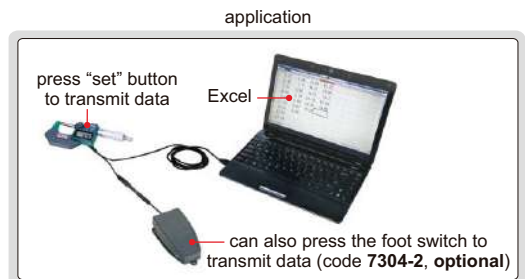

INTEGRATED BUTTON

Code	Description	Plug type to product	Socket type on product	Plug type to computer	Applicable products
7302-SPC10	cable for digital micrometers (length 1.8m)				for digital micrometers (code with suffix Q such as 3101-25ACQ) for electronic three points internal micrometers (code with suffix Q)

FOOT SWITCH

- For data transmission



7304-2

application

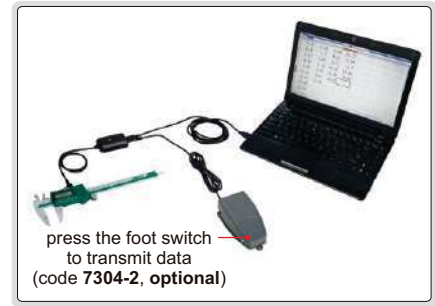

Code	Description	Applicable products
7304-2	data transmission foot switch with cable (length 2m)	7302 series data cables 7305 series data cables (separated button type)

HUBS



7302-HUB



7302-HUB7

- Suitable for USB plug data cable

application

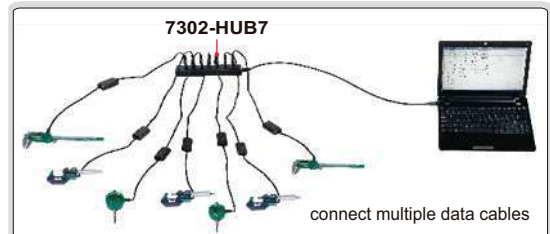

Code	Description	Applicable products
7302-HUB	4-channel hub (length 0.3m, USB computer plug)	7302 series data cables 7305 series data cables (USB plug type)
7302-HUB7	7-channel hub (length 1m, USB computer plug)	

EXTENSION CABLES



7302-ADD5

application

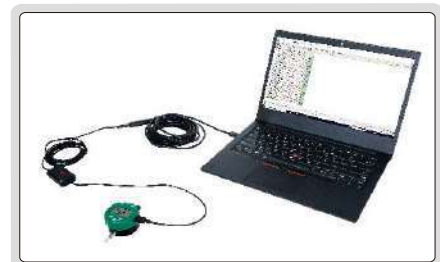

Code	Description	Applicable products
7302-ADD5	Data extension cable (length 5m, USB plug)	7302 series data cables 7305 series data cables (USB plug type)
7302-ADD10	Data extension cable (length 10m, USB plug)	

DATA OUTPUT CABLES (TEXT FORMAT, VIRTUAL COM PORT)

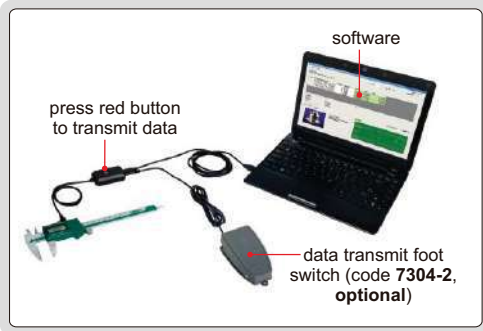

7305-A01



7305-SPC2A

Code	Description	Plug type to product	Socket type on product	Plug type to computer	Applicable products
7305-A01	cable for digital calipers (length 2.5m)				for digital calipers
7305-SPC2A					for digital height gages
7305-A05					for digital depth gages
7305-SPC2B					
7305-B01	cable for digital micrometers (length 2.5m)				for digital micrometers
7305-SPC3A					for digital three points internal micrometers
7305-C01M	cable for digital indicators (length 2.5m)				for digital indicators
7305-SPC1AM					
7305-C02M					for digital thickness gages
7305-SPC1BM					for digital internal/external caliper gages
					for digital protractors

WIRELESS DIGITAL CALIPERS (NON-WATERPROOF)



2

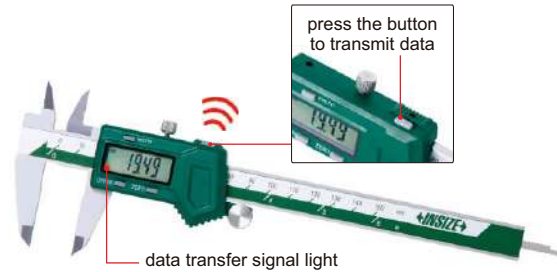
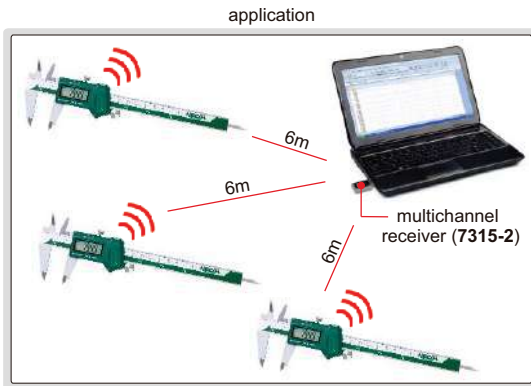

1113-150

- Built-in wireless data transfer module, Zigbee signal
- Transfer distance is 6 meter
- Resolution: 0.01mm/0.0005"
- Buttons: on/off, zero, mm/inch, data transmission
- Automatic power off, move the digital unit to turn on power
- Battery CR2032
- Made of stainless steel
- Optional accessory: receiver (code 7315-2, 7315-3)

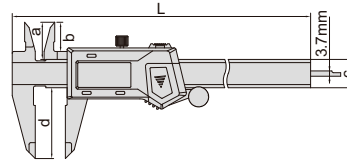

Code	Range	Accuracy	L	a	b	c	d
1113-150 *	0-150mm/0-6"	±0.03mm	236mm	21mm	16mm	16mm	40mm
1113-200 *	0-200mm/0-8"	±0.03mm	286mm	24mm	19mm	16mm	50mm
1113-300 *	0-300mm/0-12"	±0.03mm	400mm	25mm	20.5mm	16mm	60mm

* Supplied with manufacturer inspection certificate traceable to DKD Germany

receiver (optional)

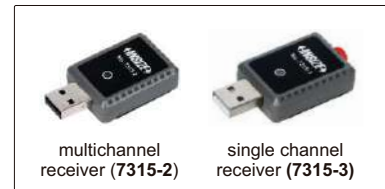

WATERPROOF DIGITAL CALIPERS

ATTENTION: IT IS NECESSARY TO SET ZERO AFTER POWER ON EACH TIME

ATTENTION: NO DATA OUTPUT

IP67 WATERPROOF



- IP67 dust/waterproof
- Resolution: 0.01mm/0.0005"
- Button function: zero, on/off, mm/inch, ABS/REL, hold
- Battery CR2032
- Meet DIN862
- Made of stainless steel



1118-150B

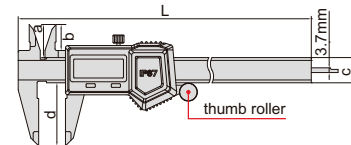

Code	Range	Accuracy	Thumb roller	L	a	b	c	d
1118-150B *	0-150mm/0-6"	±0.03mm	with	236mm	21mm	16mm	16mm	40mm
1118-200B *	0-200mm/0-8"	±0.03mm	with	286mm	24mm	19mm	16mm	50mm
1118-300B *	0-300mm/0-12"	±0.03mm	with	400mm	25mm	20.5mm	17mm	60mm
1118-150BW *	0-150mm/0-6"	±0.03mm	without	236mm	21mm	16mm	16mm	40mm
1118-200BW *	0-200mm/0-8"	±0.03mm	without	286mm	24mm	19mm	16mm	50mm
1118-300BW *	0-300mm/0-12"	±0.03mm	without	400mm	25mm	20.5mm	17mm	60mm

* Supplied with manufacturer inspection certificate traceable to DKD Germany



ATTENTION:
NO DATA OUTPUT

IP67
WATERPROOF

WATERPROOF DIGITAL CALIPERS

- IP67 dust/waterproof
- Resolution: 0.01mm/0.0005"
- Large display
- Button function: zero, on/off, mm/inch
- Battery CR2032
- Made of stainless steel



1126-150

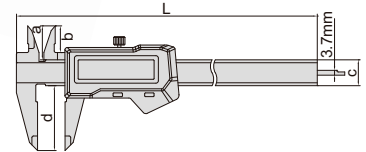

Code	Range	Accuracy	L	a	b	c	d
1126-150 *	0-150mm/0-6"	±0.03mm	234mm	20mm	15mm	16mm	40mm
1126-200 *	0-200mm/0-8"	±0.03mm	286mm	24mm	19mm	16mm	50mm
1126-300 *	0-300mm/0-12"	±0.03mm	390mm	26mm	21.5mm	16mm	60mm

* Supplied with manufacturer inspection certificate traceable to DKD Germany



ATTENTION:
NO DATA OUTPUT

DIGITAL CALIPERS (NON-WATERPROOF)

- Zinc alloy housing for digital unit
- Resolution: 0.01mm/0.0005"
- Buttons: zero, on/off, mm/inch
- Automatic power off, move the digital unit to turn on power
- Battery CR2032
- Meet DIN862
- Made of stainless steel



1114-150A

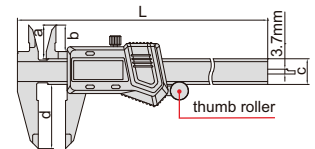

Code	Range	Accuracy	Thumb roller	L	a	b	c	d
1114-150A *	0-150mm/0-6"	±0.03mm	with	236mm	21mm	16mm	16mm	40mm
1114-200A *	0-200mm/0-8"	±0.03mm	with	286mm	24mm	19mm	16mm	50mm
1114-300A *	0-300mm/0-12"	±0.03mm	with	400mm	25mm	20.5mm	17mm	60mm
1114-150AW *	0-150mm/0-6"	±0.03mm	without	236mm	21mm	16mm	16mm	40mm
1114-200AW *	0-200mm/0-8"	±0.03mm	without	286mm	24mm	19mm	16mm	50mm
1114-300AW *	0-300mm/0-12"	±0.03mm	without	400mm	25mm	20.5mm	17mm	60mm

* Supplied with manufacturer inspection certificate traceable to DKD Germany



DATA
OUTPUT

DIGITAL CALIPERS (STANDARD TYPE, NON-WATERPROOF)

- Resolution: 0.01mm/0.0005"
- Buttons: on/off, zero, mm/inch
- Automatic power off, move the digital unit to turn on power
- Battery CR2032
- Data output
- Meet DIN862
- Made of stainless steel
- Optional accessory: data output cable (code 7315-, 7302-, 7305-)



1108-150

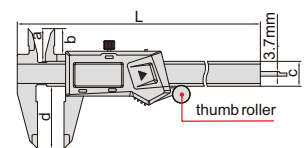

Code	Range	Accuracy	Thumb roller	L	a	b	c	d
1108-150 *	0-150mm/0-6"	±0.02mm	with	236mm	21mm	16mm	16mm	40mm
1108-200 *	0-200mm/0-8"	±0.03mm	with	286mm	24mm	19mm	16mm	50mm
1108-250 *	0-250mm/0-10"	±0.03mm	with	350mm	25mm	20.5mm	16mm	60mm
1108-300 *	0-300mm/0-12"	±0.03mm	with	400mm	25mm	20.5mm	16mm	60mm
1108-150W *	0-150mm/0-6"	±0.02mm	without	236mm	21mm	16mm	16mm	40mm
1108-200W *	0-200mm/0-8"	±0.03mm	without	286mm	24mm	19mm	16mm	50mm
1108-250W *	0-250mm/0-10"	±0.03mm	without	350mm	25mm	20.5mm	16mm	60mm
1108-300W *	0-300mm/0-12"	±0.03mm	without	400mm	25mm	20.5mm	16mm	60mm

* Supplied with manufacturer inspection certificate traceable to DKD Germany

HEAVY DUTY 300mm DIGITAL CALIPERS (NON-WATERPROOF)

DATA OUTPUT

INSPECTION CERTIFICATE TRACEABLE TO DKD

- Resolution: 0.01mm/0.0005"
- Buttons: on/off, zero, mm/inch
- Automatic power off, move the digital unit to turn on power
- Battery CR2032
- Data output
- Meet DIN862
- Made of stainless steel
- Optional accessory: data output cable (code 7315-, 7302-, 7305-)



1196-300

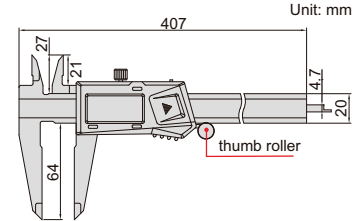

Code	Range	Thumb roller	Accuracy
1196-300 *	0-300mm/0-12"	with	±0.03mm
1196-300W *	0-300mm/0-12"	without	±0.03mm

*Supplied with manufacturer inspection certificate traceable to DKD Germany

METRIC DIGITAL CALIPERS (NON-WATERPROOF)

LOCK READING WITH "HOLD" BUTTON

DATA OUTPUT

INSPECTION CERTIFICATE TRACEABLE TO DKD

- Resolution: 0.01mm
- Buttons: on/off, zero, hold
- Automatic power off, move the digital unit to turn on power
- Battery CR2032
- Data output
- Meet DIN862
- Made of stainless steel
- Optional accessory: data output cable (code 7315-, 7302-, 7305-)



1109-150

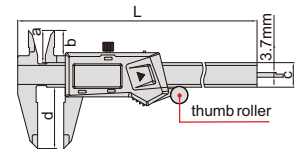

Code	Range	Accuracy	Thumb roller	L	a	b	c	d
1109-150 *	0-150mm	±0.03mm	with	236mm	21mm	16mm	16mm	40mm
1109-200 *	0-200mm	±0.03mm	with	286mm	24mm	19mm	16mm	50mm
1109-300 *	0-300mm	±0.03mm	with	400mm	25mm	20.5mm	16mm	60mm
1109-150W *	0-150mm	±0.03mm	without	236mm	21mm	16mm	16mm	40mm
1109-200W *	0-200mm	±0.03mm	without	286mm	24mm	19mm	16mm	50mm
1109-300W *	0-300mm	±0.03mm	without	400mm	25mm	20.5mm	16mm	60mm

*Supplied with manufacturer inspection certificate traceable to DKD Germany

DIGITAL CALIPERS WITH ROUND DEPTH BAR (NON-WATERPROOF)

DATA OUTPUT

INSPECTION CERTIFICATE TRACEABLE TO DKD

- Resolution: 0.01mm/0.0005"
- Buttons: on/off, zero, mm/inch
- Automatic power off, move the digital unit to turn on power
- Battery CR2032
- Data output
- Meet DIN862
- Made of stainless steel
- Optional accessory: data output cable (code 7315-, 7302-, 7305-, for calipers without built-in wireless)



1119-150



round depth bar Ø1.6mm

(mm)

Code	Range	Accuracy	Thumb roller	L	a	b	c	d	Wireless
1119-150 *	0-150mm/0-6"	±0.03mm	with	236	21	16	16	40	no
built-in wireless									
1119-150W *	0-150mm/0-6"	±0.03mm	without	236	21	16	16	40	no
1119-150WWL *									built-in wireless

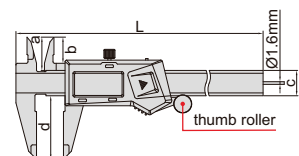

*Supplied with manufacturer inspection certificate traceable to DKD Germany

LEFT HAND DIGITAL CALIPERS (NON-WATERPROOF)

- Designed for left handed users
- Resolution: 0.01mm/0.0005"
- Buttons: on/off, zero, mm/inch
- Automatic power off, move the digital unit to turn on power
- Battery CR2032
- Data output
- Meet DIN862
- Made of stainless steel
- Optional accessory: data output cable (code 7315-, 7302-, 7305-)



1130-150

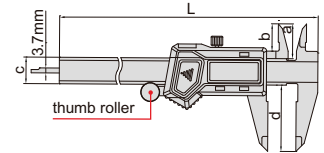

Code	Range	Accuracy	Thumb roller	L	a	b	c	d
1130-150*	0-150mm/0-6"	±0.03mm	with	236mm	21mm	16mm	16mm	40mm
1130-200*	0-200mm/0-8"	±0.03mm	with	286mm	24mm	19mm	16mm	50mm
1130-300*	0-300mm/0-12"	±0.03mm	with	400mm	25mm	20.5mm	16mm	60mm
1130-150W*	0-150mm/0-6"	±0.03mm	without	236mm	21mm	16mm	16mm	40mm
1130-200W*	0-200mm/0-8"	±0.03mm	without	286mm	24mm	19mm	16mm	50mm
1130-300W*	0-300mm/0-12"	±0.03mm	without	400mm	25mm	20.5mm	16mm	60mm

*Supplied with manufacturer inspection certificate traceable to DKD Germany

DIGITAL CALIPERS WITH CERAMIC TIPPED JAWS (NON-WATERPROOF)

ceramic tipped jaws



- Ceramic tipped jaws for outside measurement, extremely wear-resistant, non-magnetic, non-conductive
- Resolution: 0.01mm/0.0005"
- Buttons: on/off, zero, mm/inch
- Automatic power off, move the digital unit to turn on power
- Battery CR2032, data output, made of stainless steel
- Meet DIN862
- Optional accessory: data output cable (code 7315-, 7302-, 7305-, for calipers without built-in wireless)



1193-150

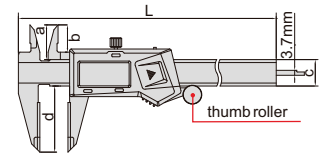

Code	Range	Accuracy	Thumb roller	L	a	b	c	d	Wireless
1193-150*	0-150mm/0-6"	±0.03mm	with	235mm	21mm	16.5mm	16mm	40mm	no
1193-150WL*									built-in wireless
1193-200*	0-200mm/0-8"	±0.03mm	with	297mm	24mm	20mm	16mm	50mm	no
1193-200WL*									built-in wireless
1193-300*	0-300mm/0-12"	±0.03mm	with	390mm	26mm	21.5mm	16mm	60mm	no
1193-300WL*									built-in wireless
1193-150W*	0-150mm/0-6"	±0.03mm	without	235mm	21mm	16.5mm	16mm	40mm	no
1193-150WWL*									built-in wireless
1193-200W*	0-200mm/0-8"	±0.03mm	without	297mm	24mm	20mm	16mm	50mm	no
1193-200WWL*									built-in wireless
1193-300W*	0-300mm/0-12"	±0.03mm	without	390mm	26mm	21.5mm	16mm	60mm	no
1193-300WWL*									built-in wireless

*Supplied with manufacturer inspection certificate traceable to DKD Germany

DIGITAL CALIPERS WITH CARBIDE TIPPED JAWS (NON-WATERPROOF)



DATA OUTPUT

- Carbide tipped jaws for inside and outside measurements
- Resolution: 0.01mm/0.0005"
- Buttons: on/off, zero, mm/inch
- Automatic power off, move the digital unit to turn on power
- Battery CR2032
- Data output
- Meet DIN862
- Made of stainless steel
- Optional accessory: data output cable (code 7315-, 7302-, 7305-, for calipers without built-in wireless)



1110-150A

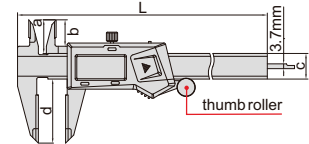

Code	Range	Accuracy	Thumb roller	L	a	b	c	d	Wireless
1110-150A*	0-150mm/0-6"	±0.03mm	with	236mm	21mm	16mm	16mm	40mm	no
1110-150AWL*									built-in wireless
1110-200A*	0-200mm/0-8"	±0.03mm	with	286mm	24mm	19mm	16mm	50mm	no
1110-200AWL*									built-in wireless
1110-300A*	0-300mm/0-12"	±0.03mm	with	400mm	25mm	20.5mm	16mm	60mm	no
1110-300AWL*									built-in wireless
1110-150AW*	0-150mm/0-6"	±0.03mm	without	236mm	21mm	16mm	16mm	40mm	no
1110-150AWWL*									built-in wireless
1110-200AW*	0-200mm/0-8"	±0.03mm	without	286mm	24mm	19mm	16mm	50mm	no
1110-200AWWL*									built-in wireless
1110-300AW*	0-300mm/0-12"	±0.03mm	without	400mm	25mm	20.5mm	16mm	60mm	no
1110-300AWWL*									built-in wireless

*Supplied with manufacturer inspection certificate traceable to DKD Germany

DIGITAL CALIPERS (NON-WATERPROOF)

DATA OUTPUT

- Resolution: 0.01mm/0.0005"
- Buttons: on/off, zero, mm/inch
- Automatic power off, move the digital unit to turn on power
- Battery CR2032
- Data output
- Made of stainless steel
- Optional accessory: data output cable (code 7315-, 7302-, 7305-, for calipers without built-in wireless)



1170-300

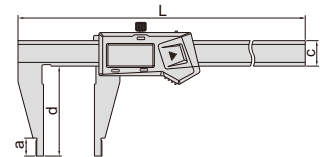
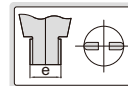

Code	Range	Accuracy	a	c	d	e	L	Wireless
1170-200	0-200mm/0-8"	±0.03mm	12mm	17mm	60mm	10mm	320mm	no
1170-200WL								built-in wireless
1170-306	0-300mm/0-12"	±0.04mm	12mm	17mm	60mm	10mm	420mm	no
1170-306WL								built-in wireless
1170-300	0-300mm/0-12"	±0.06mm	12mm	17mm	90mm	10mm	420mm	no
1170-300WL								built-in wireless

DATA
OUTPUT

DIGITAL CALIPERS (NON-WATERPROOF)

2



1171-300

- Resolution: 0.01mm/0.0005"
- Buttons: on/off, zero, mm/inch
- Automatic power off, move the digital unit to turn on power
- Battery CR2032
- Data output
- Made of stainless steel
- Optional accessory: data output cable (code 7315-, 7302-, 7305-, for calipers without built-in wireless)

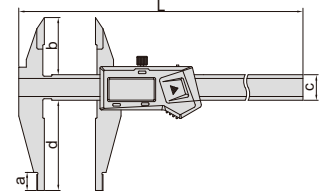
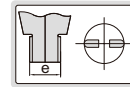

Code	Range	Accuracy	a	b	c	d	e	L	Wireless
1171-200	0-200mm/0-8"	±0.03mm	12mm	38mm	17mm	60mm	10mm	320mm	no
1171-200WL									built-in wireless
1171-250	0-250mm/0-10"	±0.03mm	12mm	38mm	17mm	60mm	10mm	365mm	no
1171-250WL									built-in wireless
1171-306	0-300mm/0-12"	±0.04mm	12mm	38mm	17mm	60mm	10mm	420mm	no
1171-306WL									built-in wireless
1171-300	0-300mm/0-12"	±0.06mm	12mm	38mm	17mm	90mm	10mm	420mm	no
1171-300WL									built-in wireless

ATTENTION:
NO DATA OUTPUT

MINI DIGITAL CALIPERS (NON-WATERPROOF)

- Resolution: 0.01mm/0.0005"
- Buttons: zero, mm/inch, on/off
- Automatic power off, move the digital unit to turn on power
- Battery LR44
- Meet DIN862
- Made of stainless steel



1111-100A

Code	Range	Accuracy	L
1111-75A	0-75mm/0-3"	±0.02mm	144mm
1111-100A	0-100mm/0-4"	±0.02mm	170mm

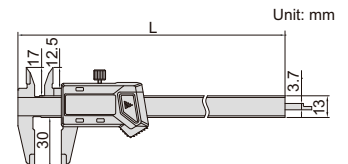

ATTENTION:
NO DATA OUTPUT

PLASTIC DIGITAL CALIPER (NON-WATERPROOF)

- Made of hard plastic, non-magnetic and non electric conductive
- Prevent workpieces from scratching by calipers
- Resolution: 0.01mm/0.0005"
- Buttons: on/off, zero, mm/inch
- Battery CR2032, automatic power off



1139-150

Code	Range	Accuracy
1139-150	0-150mm/0-6"	±0.1mm

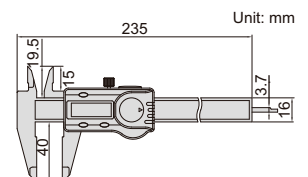

DIAL CALIPERS

SHOCK PROOF

INSPECTION CERTIFICATE
TRACEABLE TO DKD

- Shockproof dial indicator
- Made of stainless steel



1312-150A

Dial indicator graduation: 0.02mm

(mm)

Code	Range	Accuracy	Thumb roller	L	a	b	c	d	D	t
1312-150A*	0-150mm	±0.03mm	with	235	21	16.5	16	40	Ø39	6.5
1312-200A*	0-200mm	±0.03mm	with	288	24	19	16	48	Ø39	6.5
1312-300A*	0-300mm	±0.03mm	with	410	28	22	20	62	Ø44.5	7.5
1312-100AW*	0-100mm	±0.02mm	without	165	18	13	13	30	Ø32	6
1312-150AW*	0-150mm	±0.03mm	without	235	21	16.5	16	40	Ø39	6.5
1312-200AW*	0-200mm	±0.03mm	without	288	24	19	16	48	Ø39	6.5
1312-300AW*	0-300mm	±0.03mm	without	410	28	22	20	62	Ø44.5	7.5

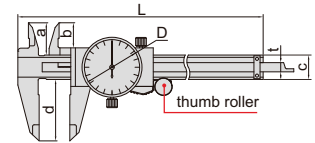

Dial indicator graduation: 0.01mm

(mm)

Code	Range	Accuracy	Thumb roller	L	a	b	c	d	D	t
1311-150A*	0-150mm	±0.03mm	with	235	21	16.5	16	40	Ø39	6.5
1311-200A*	0-200mm	±0.03mm	with	288	24	19	16	48	Ø39	6.5
1311-300A*	0-300mm	±0.03mm	with	410	28	22	20	62	Ø44.5	7.5
1311-150AW*	0-150mm	±0.03mm	without	235	21	16.5	16	40	Ø39	6.5
1311-200AW*	0-200mm	±0.03mm	without	288	24	19	16	48	Ø39	6.5
1311-300AW*	0-300mm	±0.03mm	without	410	28	22	20	62	Ø44.5	7.5

*Supplied with manufacturer inspection certificate traceable to DKD Germany

MINI VERNIER CALIPERS

- Meet DIN862
- Made of stainless steel
- Satin chrome plated reading surface

Code	Range	Graduation	Accuracy
1204-70	0-70mm	0.05mm	±0.05mm

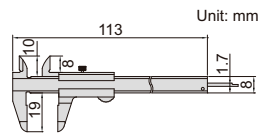

1204-70



Code	Range	Graduation	Accuracy
1203-1003	0-100mm	0.05mm	±0.05mm

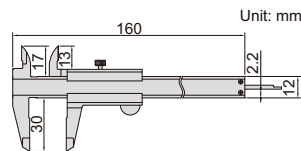

1203-1003



Code	Range	Graduation	Accuracy
1201-1003	0-100mm	0.05mm	±0.05mm

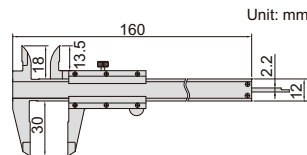

1201-1003



VERNIER CALIPERS

2

Graduation 0.05mm/1/128" (mm)

Code	Range	Accuracy	L	a	b	c	d
1205-150S	0-150mm/0-6"	±0.05mm	235	20.5	15.5	16	40
1205-200S	0-200mm/0-8"	±0.05mm	290	23.5	19	17	50
1205-250S	0-250mm/0-10"	±0.05mm	364	27.5	22	20	64
1205-300S	0-300mm/0-12"	±0.05mm	414	27.5	22	20	64



1205-150S

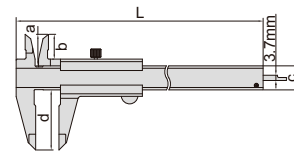

Graduation 0.05mm (mm)

Code	Range	Accuracy	L	a	b	c	d
1205-1503S	0-150mm	±0.05mm	235	20.5	15.5	16	40
1205-2003S	0-200mm	±0.05mm	290	23.5	19	17	50
1205-2503S	0-250mm	±0.05mm	350	26	21.5	16	60
1205-3003S	0-300mm	±0.05mm	414	27.5	22	20	64

Graduation 0.02mm/0.001" (mm)

Code	Range	Accuracy	L	a	b	c	d
1205-1502S	0-150mm/0-6"	±0.03mm	235	20.5	15.5	16	40
1205-2002S	0-200mm/0-8"	±0.03mm	290	23.5	19	17	50
1205-2502S	0-250mm/0-10"	±0.03mm	364	27.5	22	20	64
1205-3002S	0-300mm/0-12"	±0.03mm	414	27.5	22	20	64

Graduation 0.02mm (mm)

Code	Range	Accuracy	L	a	b	c	d
1205-1501S	0-150mm	±0.03mm	235	20.5	15.5	16	40
1205-2001S	0-200mm	±0.03mm	290	23.5	19	17	50
1205-2501S	0-250mm	±0.03mm	350	26	21.5	16	60
1205-3001S	0-300mm	±0.03mm	414	27.5	22	20	64

- Meet DIN862
- Made of stainless steel
- Satin chrome plated reading surface

VERNIER CALIPER WITH ROUND DEPTH BAR

- Graduation 0.05mm/1/128"
- Round depth bar
- Meet DIN862
- Made of stainless steel
- Satin chrome plated reading surface



1202-150

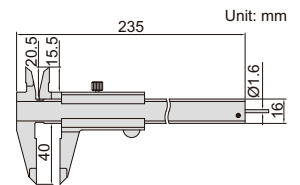

Code	Range	Accuracy
1202-150	0-150mm/0-6"	±0.05mm

VERNIER CALIPERS WITH FINE ADJUSTMENT

- Graduation 0.02mm/0.001"
- With fine adjustment
- Meet DIN862
- Made of stainless steel
- Satin chrome plated reading surface



1233-130

(mm)

Code	Range	Accuracy	L	a	b	c	d
1233-130	0-130mm/0-5"	±0.03mm	230	20.5	16.5	16	40
1233-180	0-180mm/0-7"	±0.03mm	295	23.5	19	16	50
1233-280	0-280mm/0-11"	±0.03mm	410	26	20	20	60

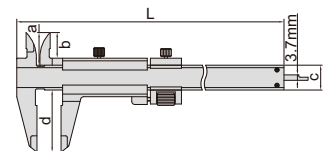

VERNIER CALIPERS WITH THUMB CLAMP

- Meet DIN862
- With thumb clamp
- Made of stainless steel
- Satin chrome plated reading surface

Graduation 0.05mm/1/128" (mm)

Code	Range	Accuracy	L	a	b	c	d
1223-150	0-150mm/0-6"	±0.05mm	230	20.5	16.5	16	40
1223-200	0-200mm/0-8"	±0.05mm	295	23.5	19	16	50

Graduation 0.02mm/0.001" (mm)

Code	Range	Accuracy	L	a	b	c	d
1223-1502	0-150mm/0-6"	±0.03mm	230	20.5	16.5	16	40
1223-2002	0-200mm/0-8"	±0.03mm	295	23.5	19	16	50



1223-150

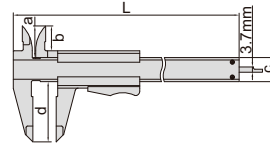

VERNIER CALIPERS WITH CARBIDE TIPPED JAWS

- Carbide tipped jaws for inside and outside measurements
- Meet DIN862
- Made of stainless steel
- Satin chrome plated reading surface

Graduation 0.05mm/1/128" (mm)

Code	Range	Accuracy	L	a	b	c	d
1238-150	0-150mm/0-6"	±0.05mm	230	21	16.5	16	40
1238-200	0-200mm/0-8"	±0.05mm	295	24	19	16	50
1238-300	0-300mm/0-12"	±0.05mm	410	25	20	17	60

Graduation 0.02mm/0.001" (mm)

Code	Range	Accuracy	L	a	b	c	d
1238-1502	0-150mm/0-6"	±0.03mm	230	21	16.5	16	40
1238-2002	0-200mm/0-8"	±0.03mm	295	24	19	16	50
1238-3002	0-300mm/0-12"	±0.03mm	410	25	20	17	60



1238-150

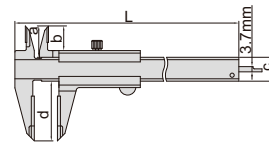

VERNIER CALIPERS

- With fine adjustment
- Made of stainless steel
- Satin chrome plated reading surface



1217-3001

Code	Range	Graduation	Accuracy	L
1217-2503	0-250mm	0.05mm	±0.05mm	360mm
1217-3001	0-300mm	0.02mm	±0.03mm	410mm

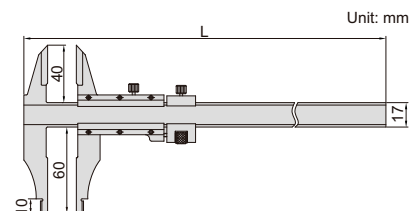
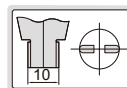

**ATTENTION:
NOT HARDENED**

VERNIER CALIPERS (ANTI MAGNETIC)

- Suitable for magnetic parts
- Graduation: 0.02mm
- Made of stainless steel
- Satin chrome plated reading surface
- Measuring faces are not hardened, HRC18-22



1224-201

(mm)

Code	Range	Accuracy	a	c	d	e	L
1224-151	0-150mm	±0.04mm	10	17	50	10	250
1224-201	0-200mm	±0.04mm	10	17	50	10	300
1224-361	0-300mm	±0.04mm	10	17	60	10	400

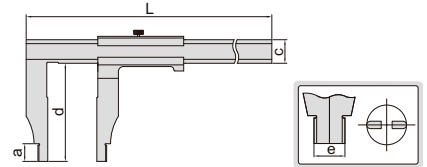

- To increase the stability of depth measurement
- Suitable for digital calipers and dial calipers
- Made of stainless steel



6140

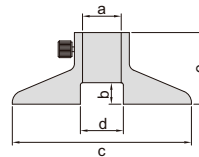

Code	a	b	c	d	e	Application
6140	16.5mm	9mm	75mm	18mm	30mm	Suitable for calipers with beam width (w) 16mm
6140-300A	20mm	15mm	125mm	22mm	34mm	Suitable for calipers with beam width (w) 20mm

ACCESSORY SET FOR DIGITAL CALIPERS CODE 6144

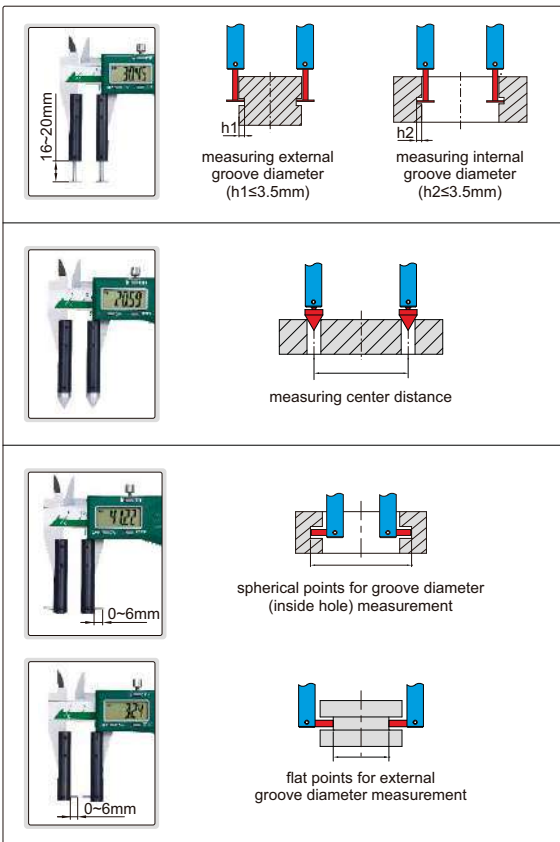

6144

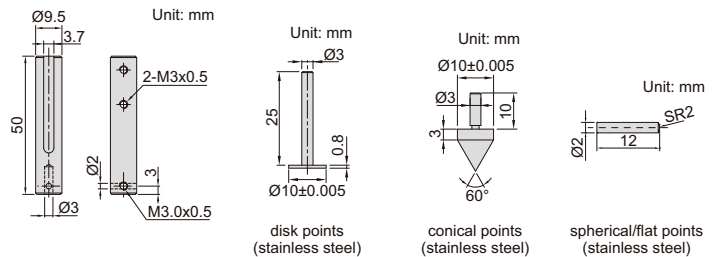

- Suitable for 0-150mm/0-6" and 0-200mm/0-8" digital calipers (thickness of lower jaws ≤ 3.7mm)

**Code
6144**

DIGITAL CALIPERS (NON-WATERPROOF)

- Resolution: 0.01mm/0.0005"
- Button function: on/off, zero, mm/inch, ABS, data preset
- Battery CR2032
- Data output
- Made of stainless steel
- Optional accessory: data output cable (code 7315-, 7302-, 7305-)



1106-501

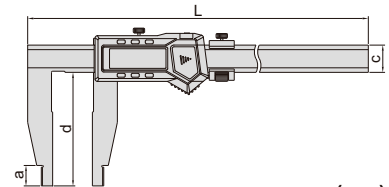
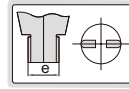

DATA OUTPUT

Code	Range	Accuracy	a	c	d	e	L
1106-301	0-300mm/0-12"	±0.05mm	18	24	100	20	420
1106-302	0-300mm/0-12"	±0.05mm	18	24	150	20	420
1106-451	0-450mm/0-18"	±0.05mm	18	24	100	20	625
1106-501	0-500mm/0-20"	±0.05mm	18	24	100	20	675
1106-502	0-500mm/0-20"	±0.06mm	18	24	150	20	675
1106-503	0-500mm/0-20"	±0.06mm	24	31	200	20	675
1106-505	0-500mm/0-20"	±0.08mm	24	42	300	20	675
1106-601	0-600mm/0-24"	±0.05mm	18	24	100	20	770
1106-602	0-600mm/0-24"	±0.06mm	18	24	150	20	770
1106-603	0-600mm/0-24"	±0.06mm	24	31	200	20	770

(mm)

Code	Range	Accuracy	a	c	d	e	L
1106-802	0-800mm/0-32"	±0.07mm	24	31	150	20	1025
1106-1002	0-1000mm/0-40"	±0.08mm	24	31	150	20	1220
1106-1003	0-1000mm/0-40"	±0.08mm	24	31	200	20	1220
1106-1005	0-1000mm/0-40"	±0.10mm	24	42	300	20	1220
1106-1502	0-1500mm/0-60"	±0.11mm	24	42	150	20	1780
1106-1503	0-1500mm/0-60"	±0.12mm	24	42	200	20	1780
1106-2002	0-2000mm/0-80"	±0.14mm	24	42	150	20	2290
1106-2003	0-2000mm/0-80"	±0.14mm	24	42	200	20	2290
1106-2502	0-2500mm/0-100"	±0.22mm	24	42	150	20	2800
1106-3002	0-3000mm/0-120"	±0.26mm	24	42	150	20	3300

(mm)

DIGITAL CALIPERS (NON-WATERPROOF)

- Resolution: 0.01mm/0.0005"
- Button function: on/off, zero, mm/inch, ABS, data preset
- Battery CR2032
- Data output
- Made of stainless steel
- Optional accessory: data output cable (code 7315-, 7302-, 7305-)



1117-501

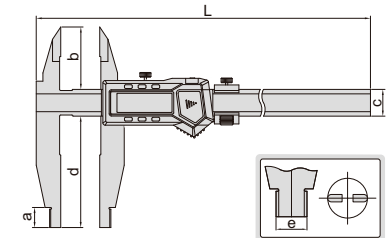

DATA OUTPUT

Code	Range	Accuracy	a	b	c	d	e	L
1117-301	0-300mm/0-12"	±0.05mm	18mm	56mm	24mm	100mm	20mm	420mm
1117-501	0-500mm/0-20"	±0.05mm	18mm	56mm	24mm	100mm	20mm	675mm
1117-502	0-500mm/0-20"	±0.06mm	18mm	56mm	24mm	150mm	20mm	675mm
1117-601	0-600mm/0-24"	±0.05mm	18mm	56mm	24mm	100mm	20mm	770mm
1117-802	0-800mm/0-32"	±0.07mm	24mm	67mm	31mm	150mm	20mm	1025mm
1117-1002	0-1000mm/0-40"	±0.08mm	24mm	67mm	31mm	150mm	20mm	1220mm

DIGITAL CALIPERS (NON-WATERPROOF)

- Resolution: 0.01mm/0.0005"
- Button function: on/off, zero, mm/inch, ABS, data preset
- Battery CR2032
- Data output
- Made of stainless steel
- Optional accessory: data output cable (code 7315-, 7302-, 7305-)



1136-501

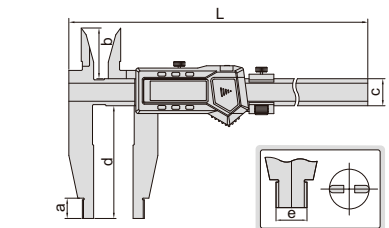

DATA OUTPUT

Code	Range	Accuracy	a	b	c	d	e	L
1136-301	0-300mm/0-12"	±0.05mm	18mm	45mm	24mm	100mm	20mm	420mm
1136-451	0-450mm/0-18"	±0.05mm	18mm	45mm	24mm	100mm	20mm	625mm
1136-501	0-500mm/0-20"	±0.05mm	18mm	45mm	24mm	100mm	20mm	675mm
1136-502	0-500mm/0-20"	±0.06mm	18mm	45mm	24mm	150mm	20mm	675mm
1136-503	0-500mm/0-20"	±0.06mm	24mm	60mm	31mm	200mm	20mm	675mm
1136-601	0-600mm/0-24"	±0.05mm	18mm	45mm	24mm	100mm	20mm	770mm
1136-1002	0-1000mm/0-40"	±0.08mm	24mm	60mm	31mm	150mm	20mm	1220mm
1136-1502	0-1500mm/0-60"	±0.11mm	24mm	60mm	42mm	150mm	20mm	1780mm
1136-2002	0-2000mm/0-80"	±0.14mm	24mm	60mm	42mm	150mm	20mm	2290mm

DATA OUTPUT
DIGITAL CALIPERS (NON-WATERPROOF)

- Resolution: 0.01mm/0.0005"
- Button function: on/off, zero, mm/inch, ABS, data preset
- Battery CR2032
- Data output
- Made of stainless steel
- Optional accessory: data output cable (code 7315-, 7302-, 7305-)

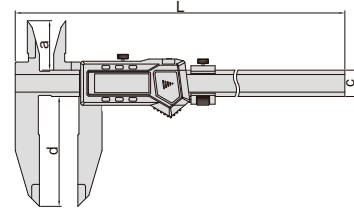
1135-601

Code	Range	Accuracy	a	c	d	L
1135-451	0-450mm/0-18"	±0.05mm	45	24	100	625
1135-601	0-600mm/0-24"	±0.05mm	45	24	100	770
1135-1002	0-1000mm/0-40"	±0.08mm	60	31	150	1220

(mm)

VERNIER CALIPERS (SOLID TYPE)

1236-521

- With fine adjustment
- Made of stainless steel
- Satin chrome plated reading surface

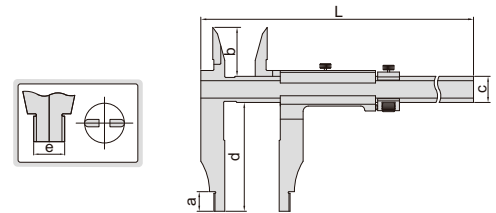
Graduation 0.05mm/1/128" (mm)

Code	Range	Accuracy	a	b	c	d	e	L
1236-394	0-300mm/0-12"	±0.07mm	12	38	20	90	10	450
1236-514	0-500mm/0-20"	±0.07mm	18	45	24	100	20	670
1236-524	0-500mm/0-20"	±0.08mm	18	45	24	150	20	670
1236-614	0-600mm/0-24"	±0.08mm	18	45	24	100	20	770
1236-824	0-800mm/0-32"	±0.09mm	24	60	31	150	20	1030
1236-1024	0-1000mm/0-40"	±0.12mm	24	60	31	150	20	1230

Graduation 0.02mm (mm)

Code	Range	Accuracy	a	b	c	d	e	L
1236-511	0-500mm	±0.05mm	18	45	24	100	20	670
1236-521	0-500mm	±0.06mm	18	45	24	150	20	670
1236-1021	0-1000mm	±0.08mm	24	60	31	150	20	1230

VERNIER CALIPERS (SOLID TYPE)

- Graduation 0.05mm/1/128"
- With fine adjustment
- Made of stainless steel
- Satin chrome plated reading surface

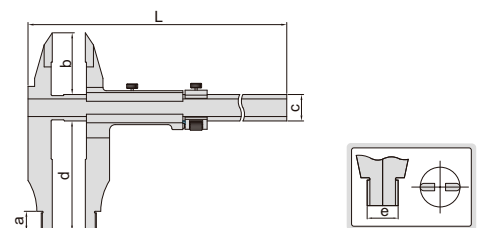
1207-514

Graduation 0.05mm/1/128" (mm)

Code	Range	Accuracy	a	b	c	d	e	L
1207-394	0-300mm/0-12"	±0.07mm	12	40	20	90	10	440
1207-514	0-500mm/0-20"	±0.07mm	18	56	24	100	20	670
1207-524	0-500mm/0-20"	±0.08mm	18	56	24	150	20	670
1207-824	0-800mm/0-32"	±0.09mm	24	67	31	150	20	930
1207-1024	0-1000mm/0-40"	±0.12mm	24	67	31	150	20	1230

VERNIER CALIPERS (SOLID TYPE)

- With fine adjustment
- Made of stainless steel
- Satin chrome plated reading surface



1208-511

Graduation 0.05mm/1/128" (mm)

Code	Range	Accuracy	a	c	d	e	L
1208-214	0-200mm/0-8"	±0.06mm	10	20	100	10	330
1208-394	0-300mm/0-12"	±0.07mm	10	20	90	10	410
1208-324	0-300mm/0-12"	±0.07mm	18	24	150	20	410
1208-524	0-500mm/0-20"	±0.08mm	18	24	150	20	670
1208-614	0-600mm/0-24"	±0.08mm	18	24	100	20	770
1208-624	0-600mm/0-24"	±0.09mm	18	24	150	20	770
1208-824	0-800mm/0-32"	±0.09mm	24	31	150	20	1030
1208-1024	0-1000mm/0-40"	±0.12mm	24	31	150	20	1230
1208-1524	0-1500mm/0-60"	±0.16mm	24	42	150	20	1820
1208-2024	0-2000mm/0-80"	±0.20mm	24	42	150	20	2330

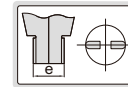
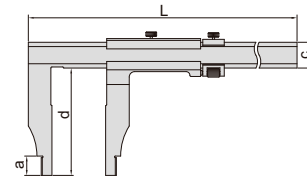

Graduation 0.02mm (mm)

Code	Range	Accuracy	a	c	d	e	L
1208-511	0-500mm	±0.05mm	18	24	100	20	670
1208-521	0-500mm	±0.06mm	18	24	150	20	670
1208-1021	0-1000mm	±0.08mm	24	31	150	20	1230
1208-1521	0-1500mm	±0.11mm	24	42	150	20	1820

VERNIER CALIPERS (SOLID TYPE)

- With fine adjustment
- Made of stainless steel
- Satin chrome plated reading surface



1210-611

Graduation 0.05mm/1/128" (mm)

Code	Range	Accuracy	a	c	d	L
1210-614	0-600mm/0-24"	±0.08mm	45	24	100	770
1210-1024	0-1000mm/0-40"	±0.12mm	60	31	150	1230

Graduation 0.02mm (mm)

Code	Range	Accuracy	a	c	d	L
1210-611	0-600mm	±0.05mm	45	24	100	770
1210-1021	0-1000mm	±0.08mm	60	31	150	1230

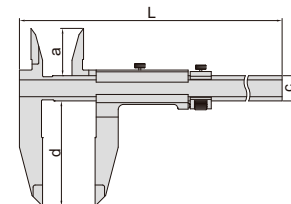

VERNIER CALIPERS

2



- With fine adjustment
- Made of stainless steel
- Satin chrome plated reading surface

1214-500

Graduation 0.02mm/0.001" (mm)

Code	Range	Accuracy	a	c	d	e	L
1214-300	0-300mm/0-12"	±0.05mm	10	20	75	10	410
1214-450	0-450mm/0-18"	±0.05mm	18	24	100	20	620
1214-500	0-500mm/0-20"	±0.05mm	18	24	100	20	670
1214-600	0-600mm/0-24"	±0.05mm	18	24	100	20	770
1214-1000	0-1000mm/0-40"	±0.08mm	24	32	140	20	1216
1214-1500	0-1500mm/0-60"	±0.12mm	24	42	200	20	1830
1214-2000	0-2000mm/0-80"	±0.14mm	24	42	200	20	2320

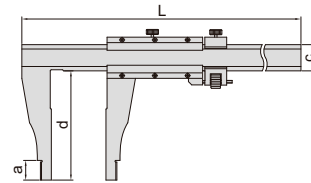

Graduation 0.05mm/1/128" (mm)

Code	Range	Accuracy	a	c	d	e	L
1214-6004	0-600mm/0-24"	±0.08mm	18	24	100	20	770
1214-1004	0-1000mm/0-40"	±0.12mm	24	32	140	20	1216

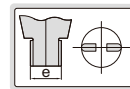

LONG JAW VERNIER CALIPERS



- With fine adjustment
- Made of stainless steel
- Satin chrome plated reading surface

1215-1032

Graduation 0.02mm/0.001" (mm)

Code	Range	Accuracy	a	c	d	e	L
1215-392	0-300mm/0-12"	±0.05mm	10	17	90	10	410
1215-322	0-300mm/0-12"	±0.05mm	18	24	150	20	470
1215-522	0-500mm/0-20"	±0.06mm	18	24	150	20	670
1215-532	0-500mm/0-20"	±0.06mm	18	24	200	20	670
1215-622	0-600mm/0-24"	±0.06mm	18	24	150	20	770
1215-642	0-600mm/0-24"	±0.08mm	24	32	250	20	870
1215-822	0-800mm/0-32"	±0.07mm	24	32	150	20	1020
1215-832	0-800mm/0-32"	±0.07mm	24	32	200	20	1020
1215-1032	0-1000mm/0-40"	±0.08mm	24	32	200	20	1220
1215-1052	0-1000mm/0-40"	±0.11mm	24	42	300	20	1330
1215-3052	0-3000mm/0-120"	±0.26mm	24	50	300	20	3360

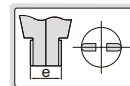
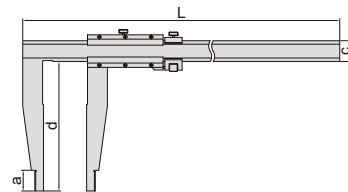

Graduation 0.05mm/1/128" (mm)

Code	Range	Accuracy	a	c	d	e	L
1215-524	0-500mm/0-20"	±0.08mm	18	24	150	20	670
1215-1034	0-1000mm/0-40"	±0.12mm	24	32	200	20	1330

UNIVERSAL CALIPER (NON-WATERPROOF) CODE 1125-600

DATA
OUTPUT

working with stands

working with measuring jaws



1125-600

- Buttons: on/off, set, mm/inch, ABS, preset (+, -)
- Automatic power off, move the digital unit to turn on power
- Battery CR2032
- Data output
- Made of stainless steel
- Optional accessory: data output cable (code 7315-, 7302-, 7305-)

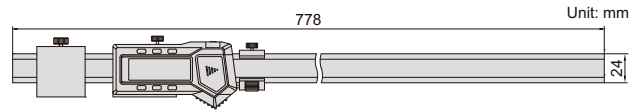

Code	Range*	Resolution	Accuracy
1125-600	0-600mm/0-24"	0.01mm/0.0005"	±0.05mm

*The range changes according to different points

Half disk points (included)

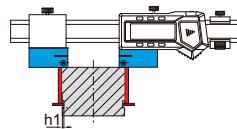
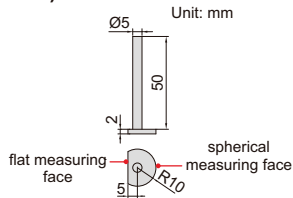

Measuring external groove diameter with flat measuring face (depth $h1 \leq 2.5\text{mm}$)

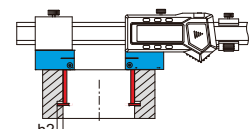

Measuring internal groove diameter with spherical measuring face (depth $h2 \leq 7.5\text{mm}$)

Conical points (optional)

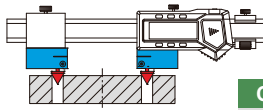
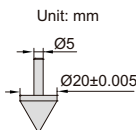

Measuring center distance

Code
1125-T101

Round shoulder points (optional)

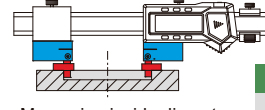
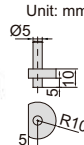

Measuring inside diameter

Code
1125-T102

Flat shoulder points (optional)

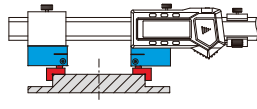
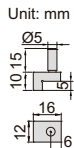

Measuring outside diameter

Code
1125-T103

Spherical points (included)

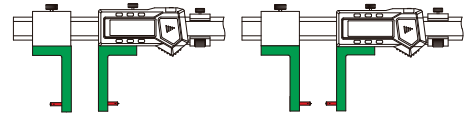
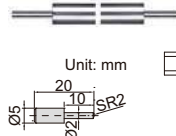

Point sleeve (optional)

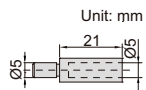
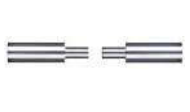

Code
1125-T104

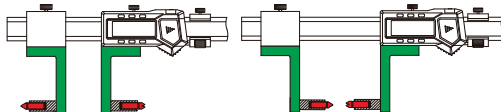

Working with multifunctional points, ball points and screw thread points

Stands (included)

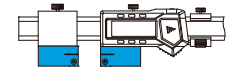
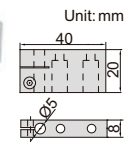

Depth stop (included)

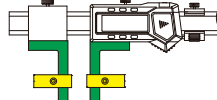
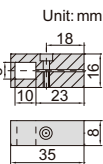

Measuring jaws (included)

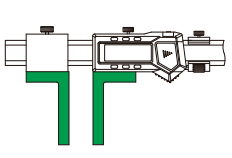
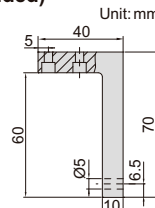

Multifunctional points 7392* (optional, next page)



Ball points 7391* (optional, next page)



Screw thread points 7381*, 7321* (optional, next page)



* It is necessary to use point sleeve (code 1526-T101) for these points

DIGITAL CALIPER WITH INTERCHANGEABLE POINTS (NON-WATERPROOF) CODE 1526-200

2

short spherical points (included) Unit: mm



long spherical/flat points (included) Unit: mm



spherical blade points (included) Unit: mm



- Supplied with 3 pairs of points and zero setting block for external measurement
- Resolution: 0.01mm/0.0005"
- Buttons: on/off, set, mm/inch, preset (+, -)
- Automatic power off, move the digital unit to turn on power
- Battery CR2032
- Data output
- Made of stainless steel
- Optional accessory: points, data output cable (code 7315-, 7302-, 7305-)



1526-200

DATA OUTPUT

measure internal and external grooves

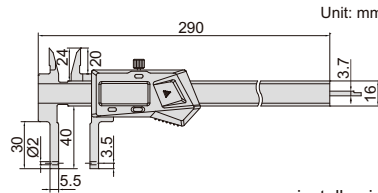
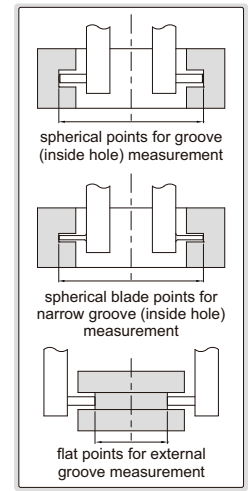

Unit: mm



preset buttons

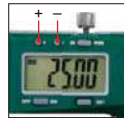

install points

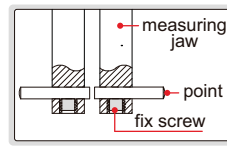

Point	Range	Accuracy	Application
short spherical points	12-212mm/0.5-8.5" (internal)	±0.03mm	for grooves inside small hole
long spherical/flat points	24-224mm/1-8.8" (internal) 0-187mm/0-7.5" (external)	±0.03mm	spherical points for grooves inside hole flat points for external grooves
spherical blade points	24-224mm/1-8.8" (internal) 0-187mm/0-7.5" (external)	±0.03mm	for narrow grooves inside hole

zero setting block for external measurement (included)



Depth stop (optional)

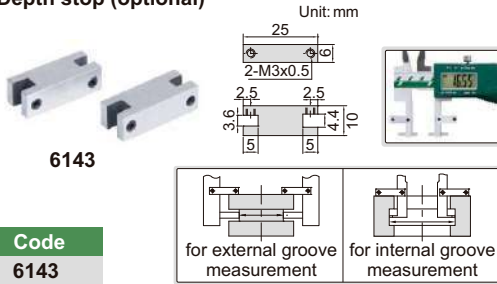

Multifunctional points (optional)

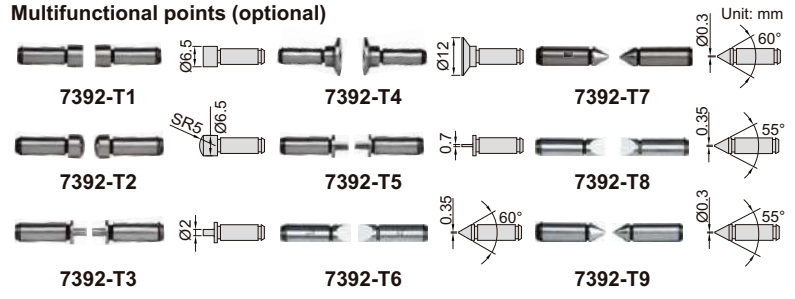

* It is necessary to use point sleeve (code 1526-T101) for these points

Point sleeve (optional)

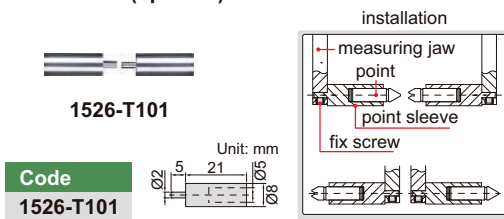

Screw thread points (optional)



Ball points (optional)

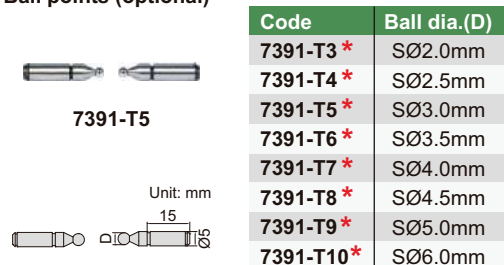

* It is necessary to use point sleeve (code 1526-T101) for these points

DIGITAL CALIPER WITH INTERCHANGEABLE POINTS (NON-WATERPROOF) CODE 1124-300A

DATA
OUTPUT

2



1124-300A

short spherical/flat points (included) Unit: mm



long spherical/flat points (included) Unit: mm



short spherical blade points (included) Unit: mm



long spherical blade points (included) Unit: mm

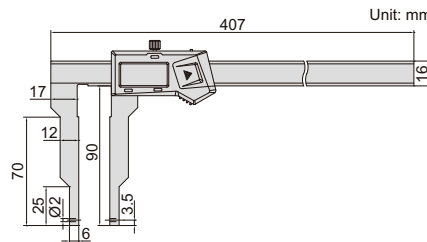
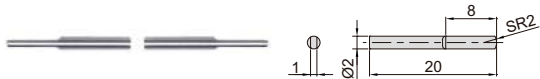

preset buttons

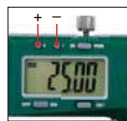

depth stop **6143**
(optional)



measure internal and external grooves

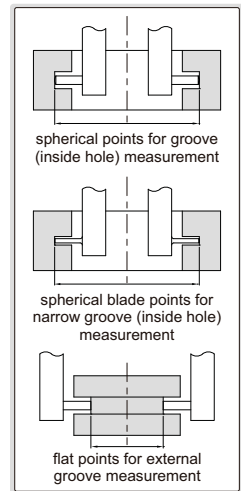

install points

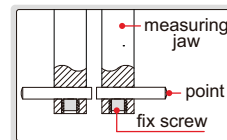

zero setting block for external measurement (included)



- Supplied with 4 pairs of points and zero setting block for external measurement
- Resolution: 0.01mm/0.0005"
- Buttons: on/off, set, mm/inch, preset (+, -)
- Automatic power off, move the digital unit to turn on power
- Battery CR2032
- Data output
- Made of stainless steel
- Optional accessory: points (code **1526-T101**, **7392**, **7391**, **7381**, **7321**), depth stop (code **6143**), data output cable (code **7315-**, **7302-**, **7305-**)

Point	Range	Accuracy	Application
short spherical/flat points	24-324mm/1-12.7" (internal) 0-288mm/0-11.3" (external)	±0.04mm	spherical points for grooves inside hole (small hole) flat points for external grooves
long spherical/flat points	40-340mm/1.5-13.3" (internal) 0-272mm/0-10.7" (external)	±0.04mm	spherical points for grooves inside hole (large hole) flat points for external grooves
short spherical blade points	24-324mm/1-12.7" (internal) 0-288mm/0-11.3" (external)	±0.04mm	for narrow grooves inside hole (small hole)
long spherical blade points	40-340mm/1.5-13.3" (internal) 0-272mm/0-10.7" (external)	±0.04mm	for narrow grooves inside hole (large hole)

Multifunctional points 7392*
(optional, refer to 1526-200 for more details)



Ball points 7391* (optional, refer to 1526-200 for more details)



Screw thread points 7381*, 7321* (optional, refer to 1526-200 for more details)



* It is necessary to use point sleeve (code **1526-T101**) for these points

DATA OUTPUT

VARIOUS POINTS ARE AVAILABLE (PAGE 126-128)

DIGITAL CALIPER WITH INTERCHANGEABLE POINTS (NON-WATERPROOF)

- Supplied with 4 pairs of points and zero setting block for external measurement
- Resolution: 0.01mm/0.0005"
- Buttons: on/off, set, mm/inch, preset (+, -)
- Automatic power off, move the digital unit to turn on power
- Battery CR2032
- Data output
- Made of stainless steel
- Optional accessory: points (page 126~128), depth stop (code **6143**), data output cable (code **7315-**, **7302-**, **7305-**)



zero setting block for external measurement (included)



depth stop **6143** (optional)



1530-300

preset buttons

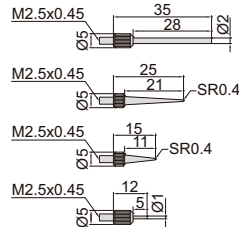
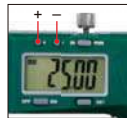

4 pairs of points (included)

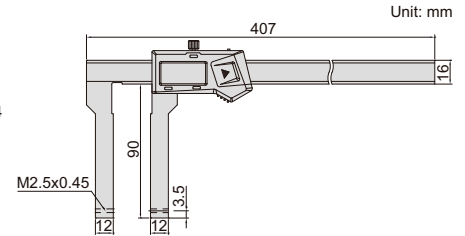
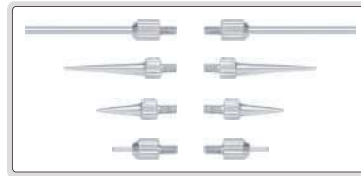

Unit: mm

measure internal and external grooves

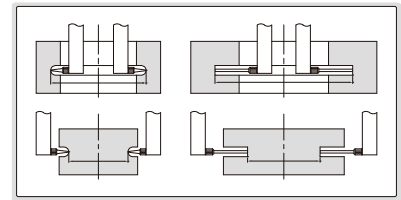

Code	Range *	Accuracy
1530-300	0-300mm/0-12"	±0.04mm

*For different points, the measuring range changes accordingly

DATA OUTPUT

DIGITAL INSIDE GROOVE CALIPERS (NON-WATERPROOF)

- Measure diameter of grooves inside small bores
- Resolution: 0.01mm/0.0005"
- Buttons: on/off, set, mm/inch, preset (+, -)
- Automatic power off, move the digital unit to turn on power
- Battery CR2032
- Data output
- Made of stainless steel
- Optional accessory: depth stop (code **6143**), data output cable (code **7315-**, **7302-**, **7305-**, for calipers without built-in wireless)



1520-150

preset buttons

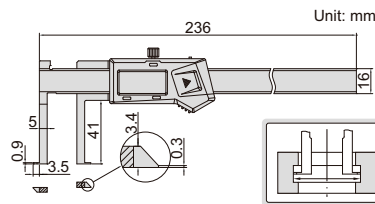
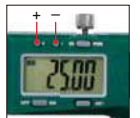

Unit: mm

depth stop **6143** (optional)



Code	Range	Accuracy	Wireless
1520-150	11-150mm/0.43-6"	±0.04mm	no
1520-150WL			built-in wireless

DATA OUTPUT

DIGITAL INSIDE GROOVE CALIPERS (NON-WATERPROOF)

- Measure groove diameter
- Resolution: 0.01mm/0.0005"
- Buttons: on/off, set, mm/inch, preset (+, -)
- Automatic power off, move the digital unit to turn on power
- Battery CR2032, data output
- Made of stainless steel
- Optional accessory: depth stop (code **6143**), data output cable (code **7315-**, **7302-**, **7305-**)

depth stop **6143** (optional)



1120-150A

preset buttons

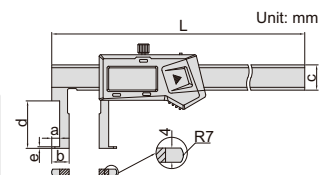
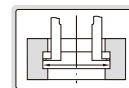
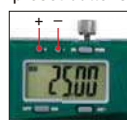

Unit: mm

Code	Range	Accuracy	L	a	b	c	d	e (mm)
1120-150A	22-150mm	±0.04mm	250	5	11	16	30	1
1120-200A	25-200mm	±0.04mm	310	5	12.5	16	40	1
1120-300A	30-300mm	±0.05mm	410	5	15	17	50	1.5

DIGITAL INSIDE POINT CALIPERS (NON-WATERPROOF)

DATA OUTPUT

- Measure groove diameter
- Resolution: 0.01mm/0.0005"
- Buttons: on/off, set, mm/inch, preset (+, -)
- Automatic power off, move the digital unit to turn on power
- Battery CR2032
- Data output
- Made of stainless steel
- Optional accessory: depth stop (code 6143), data output cable (code 7315-, 7302-, 7305-)

depth stop 6143 (optional)



1121-150A

Code	Range	Accuracy	L	a	b	c	d	D
1121-150A	24-150mm	±0.04mm	250	5	12	16	30	∅2
1121-200A	25-200mm	±0.04mm	310	5	12.5	16	40	∅2
1121-3001A	50-300mm	±0.06mm	410	8	25	17	80	∅3

preset buttons

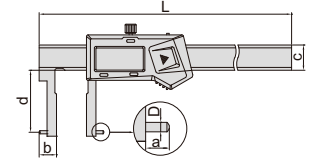
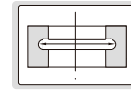
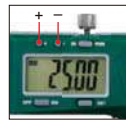

DIGITAL INSIDE GROOVE CALIPERS (NON-WATERPROOF)

DATA OUTPUT

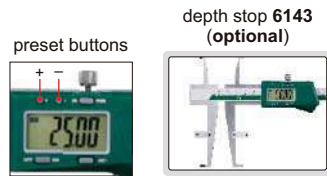

- Measure diameter of grooves inside bores
- Resolution: 0.01mm/0.0005"
- Buttons: on/off, set, mm/inch, preset (+, -)
- Automatic power off, move the digital unit to turn on power
- Battery CR2032
- Data output
- Made of stainless steel
- Optional accessory: depth stop (code 6143), data output cable (code 7315-, 7302-, 7305-, for calipers without built-in wireless)



1176-150

sizes to be measured (use upper jaws)

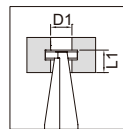

D1	L1
∅9	<8
∅10	<15
∅11~150	<30

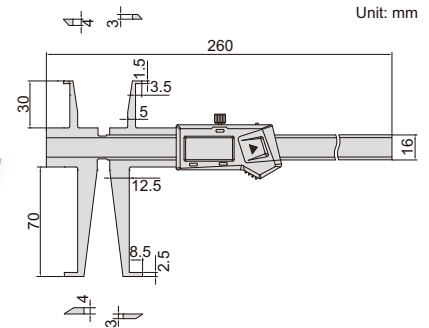

sizes to be measured (use lower jaws)

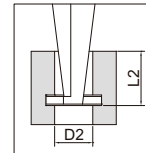

D2	L2	D2	L2
∅15	<10	∅19	<42
∅16	<18	∅20	<50
∅17	<26	∅21	<58
∅18	<34	∅22~150	<70

Code	Range of upper jaw	Range of lower jaw	Accuracy	Wireless
1176-150	9-150mm/0.35-6"	15-150mm/0.59-6"	±0.04mm	no
1176-150WL				built-in wireless

DIGITAL INSIDE GROOVE CALIPERS (NON-WATERPROOF)

DATA OUTPUT

- Measure diameter of grooves inside bores
- Resolution: 0.01mm/0.0005"
- Buttons: on/off, set, mm/inch, preset (+, -)
- Automatic power off, move the digital unit to turn on power
- Battery CR2032
- Data output
- Made of stainless steel
- Optional accessory: depth stop (code 6143), data output cable (code 7315-, 7302-, 7305-, for calipers without built-in wireless)

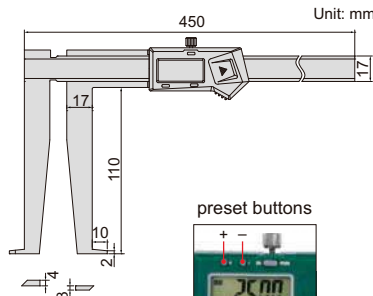

1178-300

preset buttons



depth stop 6143 (optional)



sizes to be measured

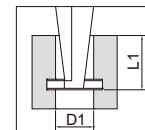

D1	L1
∅25	<50
∅26	<60
∅27~300	<110

Code	Range	Accuracy	Wireless
1178-300	25-300mm/1.18-12"	±0.05mm	no
1178-300WL			built-in wireless

DATA OUTPUT

DIGITAL OUTSIDE NECK CALIPERS (NON-WATERPROOF)

- Measure grooves and recesses
- Resolution: 0.01mm/0.0005"
- Buttons: on/off, zero, mm/inch
- Automatic power off, move the digital unit to turn on power
- Battery CR2032
- Data output
- Made of stainless steel
- Optional accessory: depth stop (code **6143**), data output cable (code **7315-**, **7302-**, **7305-**, for calipers without built-in wireless)



1187-150A

depth stop **6143** (optional)

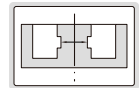
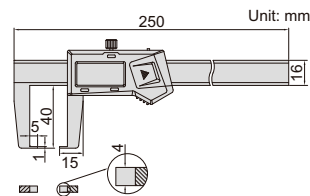

Code	Range	Accuracy	Wireless
1187-150A	0-150mm/0-6"	±0.04mm	no
1187-150AWL			built-in wireless

DATA OUTPUT

DIGITAL OUTSIDE POINT CALIPERS (NON-WATERPROOF)

- Measure wall thickness inside bores and recesses
- Resolution: 0.01mm/0.0005"
- Buttons: on/off, zero, mm/inch
- Automatic power off, move the digital unit to turn on power
- Battery CR2032
- Data output
- Made of stainless steel
- Optional accessory: depth stop (code **6143**), data output cable (code **7315-**, **7302-**, **7305-**, for calipers without built-in wireless)



1185-150A

depth stop **6143** (optional)

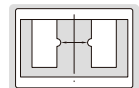
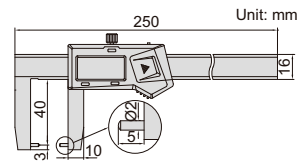

Code	Range	Accuracy	Wireless
1185-150A	0-150mm/0-6"	±0.04mm	no
1185-150AWL			built-in wireless

DEPTH STOP FOR CALIPERS

application

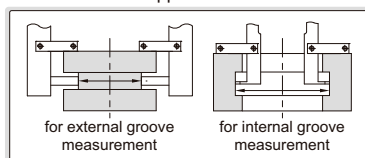

6143

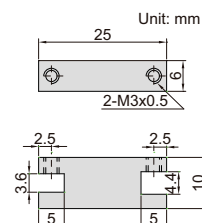

Code
6143



- Supplied in pair
- Made of stainless steel
- Suitable for caliper series **1124**, **1526**, **1530**, **1520**, **1176**, **1178**, **1120**, **1121**, **1187** and **1185**

DIGITAL BLADE CALIPERS (NON-WATERPROOF)

DATA OUTPUT

- The blade jaws fit into small grooves
- Resolution: 0.01mm/0.0005"
- Buttons: on/off, zero, mm/inch
- Automatic power off, move the digital unit to turn on power
- Battery CR2032
- Data output
- Made of stainless steel
- Optional accessory: data output cable (code 7315-, 7302-, 7305-, for calipers without built-in wireless)



1188-150A

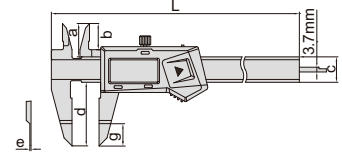
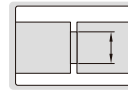

Code	Range	Accuracy	L	a	b	c	d	e	g	Wireless
1188-150A	0-150mm/0-6"	±0.03mm	235mm	21mm	16.5mm	16mm	40mm	0.75mm	17mm	no
1188-150AWL										built-in wireless
1188-200A	0-200mm/0-8"	±0.03mm	297mm	24mm	20mm	16mm	50mm	0.75mm	17mm	no
1188-200AWL										built-in wireless
1188-300A	0-300mm/0-12"	±0.04mm	390mm	26mm	21.5mm	16mm	60mm	1.00mm	17mm	no
1188-300AWL										built-in wireless

DIGITAL SMALL POINT CALIPERS (NON-WATERPROOF)

DATA OUTPUT

- Small pointed jaws fit into small grooves and recesses
- Resolution: 0.01mm/0.0005"
- Buttons: on/off, zero, mm/inch
- Automatic power off, move the digital unit to turn on power
- Battery CR2032
- Data output
- Made of stainless steel
- Optional accessory: data output cable (code 7315-, 7302-, 7305-, for calipers without built-in wireless)



1169-150

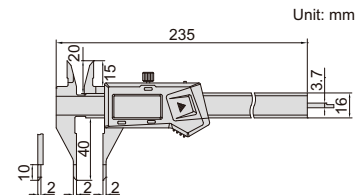
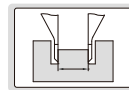

Code	Range	Accuracy	Wireless
1169-150	0-150mm/0-6"	±0.03mm	no
1169-150WL			built-in wireless

DIGITAL POINT CALIPERS (NON-WATERPROOF)

DATA OUTPUT

- Pointed jaws fit into small grooves and recesses
- Resolution: 0.01mm/0.0005"
- Buttons: on/off, zero, mm/inch
- Automatic power off, move the digital unit to turn on power
- Battery CR2032
- Data output
- Made of stainless steel
- Optional accessory: data output cable (code 7315-, 7302-, 7305-, for calipers without built-in wireless)



1183-150A

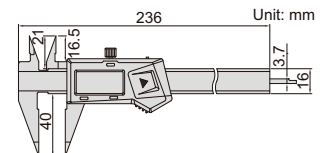
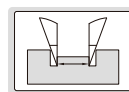

Code	Range	Accuracy	Wireless
1183-150A	0-150mm/0-6"	±0.03mm	no
1183-150AWL			built-in wireless

DATA OUTPUT
DIGITAL INSIDE KNIFE-EDGE CALIPERS (NON-WATERPROOF)

- Measure diameter of deep step holes
- Resolution: 0.01mm/0.0005"
- Buttons: on/off, zero, mm/inch
- Automatic power off, move the digital unit to turn on power
- Battery CR2032
- Data output
- Made of stainless steel
- Optional accessory: data output cable (code 7315-, 7302-, 7305-, for calipers without built-in wireless)

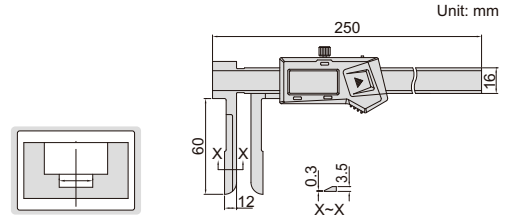
1123-150A

Code	Range	Accuracy	Wireless
1123-150A	15-150mm/0.6-6"	±0.05mm	no
1123-150AWL			built-in wireless

DATA OUTPUT
DIGITAL OFFSET CENTERLINE CALIPERS (NON-WATERPROOF)

- Measure hole center distance in the same or offset planes
- Resolution: 0.01mm/0.0005"
- Buttons: on/off, set, mm/inch, preset (+, -)
- Automatic power off, move the digital unit to turn on power
- Battery CR2032
- Data output
- Made of stainless steel
- Optional accessory: data output cable (code 7315-, 7302-, 7305-)

1192-150A

(mm)

Code	Range	Accuracy	c	∅D	L1	L2	L
1192-150A	10-150mm/0.4-6"	±0.05mm	16	10	32	65	236
1192-200A	10-200mm/0.4-8"	±0.07mm	16	10	32	65	286
1192-300A	10-300mm/0.4-12"	±0.09mm	16	10	32	65	396
1192-500A	20-500mm/0.8-20"	±0.09mm	24	20	48	88	686
1192-1000A	30-1000mm/1.2-40"	±0.12mm	31	30	48	88	1242
1192-1500A	30-1500mm/1.2-60"	±0.15mm	31	30	48	88	1745

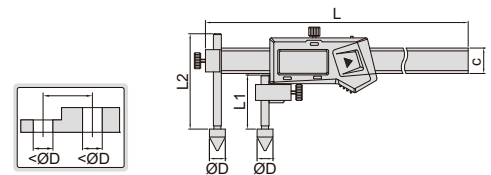

DATA OUTPUT
DIGITAL BACK-JAW CENTERLINE CALIPERS (NON-WATERPROOF)

- Measure hole center distance in the same or offset planes
- Resolution: 0.01mm/0.0005"
- Buttons: on/off, set, mm/inch, preset (+, -)
- Automatic power off, move the digital unit to turn on power
- Battery CR2032
- Data output
- Made of stainless steel
- Optional accessory: data output cable (code 7315-, 7302-, 7305-)

1177-200

(mm)

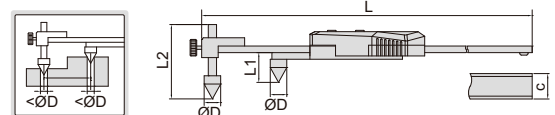
Code	Range	Accuracy	∅D	c	L1	L2	L
1177-200	10-200mm/0.4-8"	±0.10mm	10	16	18	45	310
1177-300	10-300mm/0.4-12"	±0.10mm	10	16	18	45	410
1177-500	20-500mm/0.8-20"	±0.10mm	20	24	26	70	692
1177-1000	30-1000mm/1.2-40"	±0.12mm	30	31	39	70	1242
1177-1500	30-1500mm/1.2-60"	±0.15mm	30	31	39	70	1745



DIGITAL CENTERLINE AND EDGE TO CENTER CALIPERS (NON-WATERPROOF)

DATA OUTPUT



1525-300

- Measure hole center distance or edge to hole center distance
- Resolution: 0.01mm/0.0005"
- Buttons: on/off, set, mm/inch, preset (+, -)
- Automatic power off, move the digital unit to turn on power
- Battery CR2032
- Data output
- Made of stainless steel
- Optional accessory: data output cable (code 7315-, 7302-, 7305-)

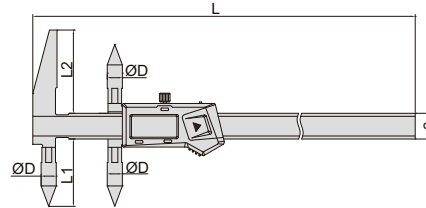

measure edge to hole center distance

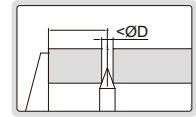

measure hole center distance

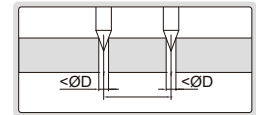

(mm)

Code	Range of upper jaw (edge to center)	Range of lower jaw (center to center)	Accuracy	ØD	L1	L2	c	L
1525-300	5-300mm/0.2-12"	10-300mm/0.4-12"	±0.08mm	10	44.5	55	17	410
1525-500	10-500mm/0.4-20"	20-50mm/0.8-20"	±0.09mm	20	40	50	24	690
1525-1000	15-1000mm/0.6-40"	30-1000mm/1.2-40"	±0.12mm	30	60	70	31	1255
1525-1500	15-1500mm/0.6-60"	30-1500mm/1.2-60"	±0.15mm	30	60	70	31	1760

DIGITAL BACK-JAW EDGE TO CENTER CALIPERS (NON-WATERPROOF)

DATA OUTPUT

- Measure edge to hole center distance
- Resolution: 0.01mm/0.0005"
- Buttons: on/off, set, mm/inch, preset (+, -)
- Automatic power off, move the digital unit to turn on power
- Battery CR2032
- Data output
- Made of stainless steel
- Optional accessory: data output cable (code 7315-, 7302-, 7305-)



1524-200

preset buttons



back-jaw

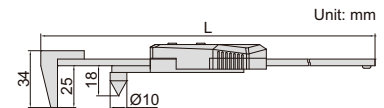
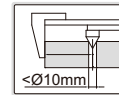

Code	Range	Accuracy	L
1524-200	5-200mm/0.2-8"	±0.1mm	310mm
1524-300	5-300mm/0.2-12"	±0.1mm	410mm

DIGITAL HOOK CALIPERS (NON-WATERPROOF)

DATA OUTPUT

- Measure width of groove inside bores
- Resolution: 0.01mm/0.0005"
- Buttons: on/off, zero, mm/inch
- Automatic power off, move the digital unit to turn on power
- Battery CR2032
- Data output
- Made of stainless steel
- Optional accessory: data output cable (code 7315-, 7302-, 7305-, for calipers without built-in wireless)



1122-200A

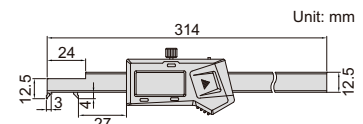
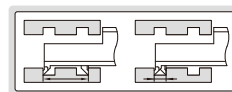

Code	Range	Accuracy	Wireless
1122-200A	3-200mm/0.12-8"	±0.03mm	no
1122-200AWL			built-in wireless

DATA OUTPUT
DIGITAL ARC RADIUS CALIPERS (NON-WATERPROOF)

- Measure the radius of arc less than half round
- Resolution: 0.01mm/0.0005"
- Buttons: on/off, zero, mm/inch
- Automatic power off, move the digital unit to turn on power
- Battery CR2032
- Data output
- Made of stainless steel
- Optional accessory: data output cable (code 7315-, 7302-, 7305-, for calipers without built-in wireless)

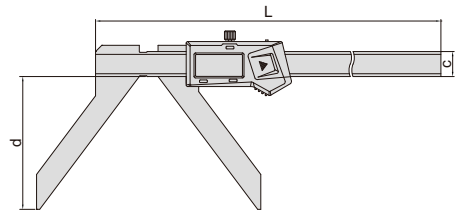
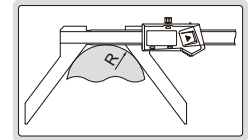
1189-150B

Code	Range (R)	Accuracy	L	c	d	Wireless
1189-150B	5-150mm/0.2-6"	±0.05mm	263mm	16mm	65mm	no
1189-150BWL						built-in wireless
1189-200B	5-200mm/0.2-8"	±0.07mm	313mm	16mm	85mm	no
1189-200BWL						built-in wireless

DATA OUTPUT
DIGITAL OFFSET CALIPERS (NON-WATERPROOF)

- The left jaw can slide up and down to facilitate measurement of stepped sections
- Resolution: 0.01mm/0.0005"
- Buttons: on/off, zero, mm/inch
- Automatic power off, move the digital unit to turn on power
- Battery CR2032, data output
- Made of stainless steel
- Optional accessory: data output cable (code 7315-, 7302-, 7305-, for calipers without built-in wireless)

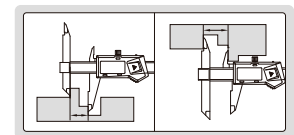
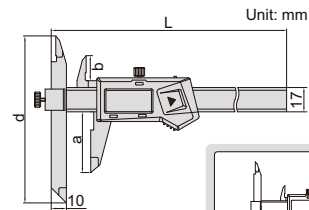
1186-150A

Code	Range	Accuracy	L	a	b	d	Wireless
1186-150A	0-150mm/0-6"	±0.04mm	239	40	16.5	110	no
1186-150AWL							built-in wireless
1186-200A	0-200mm/0-8"	±0.04mm	289	50	19.5	120	no
1186-200AWL							built-in wireless
1186-300A	0-300mm/0-12"	±0.05mm	389	60	20.5	130	no
1186-300AWL							built-in wireless

DATA OUTPUT
DIGITAL TUBE THICKNESS CALIPERS (NON-WATERPROOF)

- Measure wall thickness of tubes
- Resolution: 0.01mm/0.0005"
- Buttons: on/off, zero, mm/inch
- Automatic power off, move the digital unit to turn on power
- Battery CR2032
- Data output
- Made of stainless steel
- Optional accessory: data output cable (code 7315-, 7302-, 7305-, for calipers without built-in wireless)

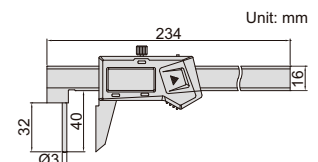
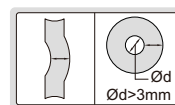
1161-150A

Code	Range	Accuracy	Wireless
1161-150A	0-150mm/0-6"	±0.05mm	no
1161-150AWL			built-in wireless

DIGITAL CALIPER WITH INTERCHANGEABLE BALL TIPS (NON-WATERPROOF)

DATA OUTPUT

2



1527-3001

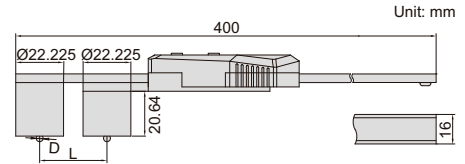

Unit: mm

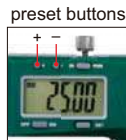

Ball tips (optional, supplied in pair)

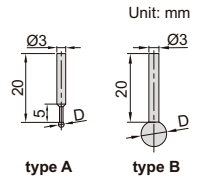

- Resolution 0.01mm/.0005"
- Buttons: on/off, set, mm/inch, preset (+, -)
- Automatic power off, move the digital unit to turn on power
- Battery CR2032, data output
- Made of stainless steel
- Optional accessory: ball tips, data output cable (code 7315-, 7302-, 7305-)

Code	Range	Accuracy
1527-3001	(22.22+D)~300mm*	±0.03mm

*"D" is the diameter of ball tips.

Code	Diameter (D)	Accuracy of diameter	Type	Material
1527-T101	1/16" (Ø1.5875mm)	±0.005mm	A	Ruby
1527-T102	1/8" (Ø3.175mm)	±0.005mm	B	Stainless steel
1527-T103	3/16" (Ø4.7625mm)	±0.005mm	B	Stainless steel
1527-T104	1/4" (Ø6.35mm)	±0.005mm	B	Stainless steel
1527-T105	3/8" (Ø9.525mm)	±0.005mm	B	Stainless steel
1527-T106	1/2" (Ø12.7mm)	±0.005mm	B	Stainless steel

DIGITAL CALIPER WITH INTERCHANGEABLE BALL TIPS (NON-WATERPROOF)

DATA OUTPUT



ball tips are optional

1528-3001

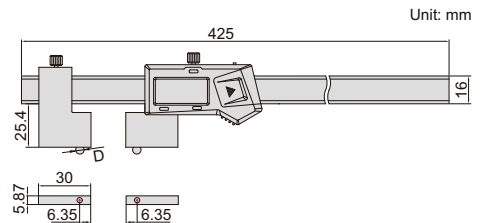

Unit: mm

Ball tips (optional, supplied in pair)

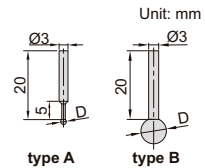

- Resolution 0.01mm/.0005"
- Buttons: on/off, set, mm/inch, preset (+, -)
- Automatic power off, move the digital unit to turn on power
- Battery CR2032, data output
- Made of stainless steel
- Optional accessory: ball tips, data output cable (code 7315-, 7302-, 7305-)

Code	Range	Accuracy
1528-3001	(12.7+D)~300mm*	±0.03mm

*"D" is the diameter of ball tips.

Code	Diameter (D)	Accuracy of diameter	Type	Material
1527-T101	1/16" (Ø1.5875mm)	±0.005mm	A	Ruby
1527-T102	1/8" (Ø3.175mm)	±0.005mm	B	Stainless steel
1527-T103	3/16" (Ø4.7625mm)	±0.005mm	B	Stainless steel
1527-T104	1/4" (Ø6.35mm)	±0.005mm	B	Stainless steel
1527-T105	3/8" (Ø9.525mm)	±0.005mm	B	Stainless steel
1527-T106	1/2" (Ø12.7mm)	±0.005mm	B	Stainless steel

DATA OUTPUT

DIGITAL RTJ RING GROOVE CALIPERS (NON-WATERPROOF)

- Measure ring grooves of flange
- Resolution: 0.01mm/0.0005"
- Button function: on/off, set, zero, mm/inch, data preset
- Battery CR2032, data output
- Made of stainless steel
- Optional accessory: data output cable (code 7315-, 7302-, 7305-)

measure outside diameter of RTJ ring groove

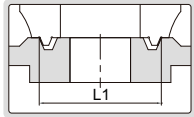

measure inside diameter of RTJ ring groove

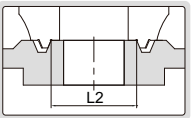

1179-300



1179-600

1179-300 preset buttons

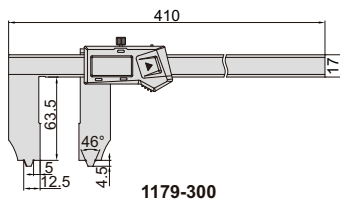

1179-300

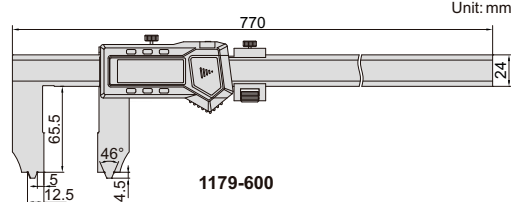

1179-600

applicable for RTJ ring grooves with angle 23°

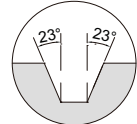

10mm and 25mm need to be added on the reading

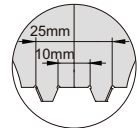

Code	Range (inside diameter of RTJ ring groove)	Range (outside diameter of RTJ ring groove)	Angle of RTJ ring groove	Accuracy
1179-300	10-300mm/0.4-12"	25-300mm/1-12"	23°	±0.06mm
1179-600	10-600mm/0.4-24"	25-600mm/1-24"	23°	±0.07mm

RELATIVE PRODUCT: CRIMP HEIGHT MICROMETER (CODE 3266-25BA, 3566-25BA)

DIGITAL CRIMP HEIGHT CALIPERS (NON-WATERPROOF)

- Measure crimp height
- Resolution: 0.01mm/0.0005"
- Buttons: on/off, zero, mm/inch
- Automatic power off, move the digital unit to turn on power
- Battery CR2032, data output, meet DIN862
- Made of stainless steel
- Optional accessory: data output cable (code 7315-, 7302-, 7305-, for calipers without built-in wireless)

Code	Range	Accuracy	Wireless
1165-150A	0-150mm/0-6"	±0.03mm	no
1165-150AWL			built-in wireless



1165-150A

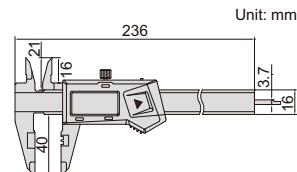

DATA OUTPUT

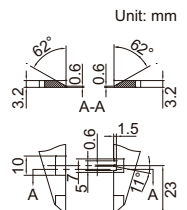

DATA OUTPUT

DIGITAL CALIPERS WITH LARGE MEASURING FACES (NON-WATERPROOF)

- Measure diameter of wire ropes, and thickness of soft materials like rubber, sponge, etc.
- Resolution: 0.01mm/0.0005"
- Buttons: on/off, zero, mm/inch
- Automatic power off, move the digital unit to turn on power
- Battery CR2032, data output
- Made of stainless steel
- Optional accessory: data output cable (code 7315-, 7302-, 7305-, for calipers without built-in wireless)



1172-200

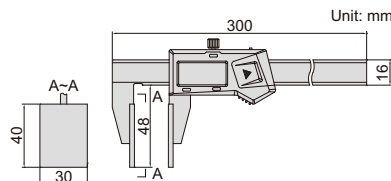

measure diameter of wire ropes

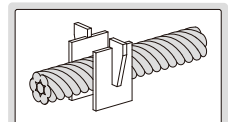

measure thickness of rubber, sponge, etc.

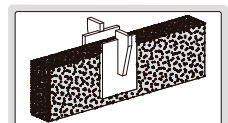

Code	Range	Accuracy	Wireless
1172-200	0-200mm/0-8"	±0.07mm	no
1172-200WL			built-in wireless

2

DIGITAL V SHAPE CALIPERS (NON-WATERPROOF)

- Measure the outside diameter of odd number of flutes (such as taps, reamers, end mills and gears)
- Direct reading, calculation is not required
- Resolution: 0.01mm/0.0005"
- Buttons: mm/inch, on/off, origin set
- Battery LR44, automatic power off
- After automatic power off, move the digital unit to turn on power
- Data output
- Made of stainless steel
- Optional accessory: 50mm calibration cylinder (code **6316-50**), data output cable (code **7302-SPC9**)



1529-5

DIRECT READING, CALCULATION IS NOT REQUIRED

DATA OUTPUT

Code	Range (D)	Flutes	Accuracy	Angle α	L (mm)
1529-3	50-200mm/2-8"	3	$\pm 0.06\text{mm}$	60°	390
1529-5	50-200mm/2-8"	5	$\pm 0.06\text{mm}$	108°	318
1529-19	50-200mm/2-8"	19	$\pm 0.06\text{mm}$	85°15'47"	336
1529-23	50-200mm/2-8"	23	$\pm 0.06\text{mm}$	70°26'5"	362
1529-31	50-200mm/2-8"	31	$\pm 0.06\text{mm}$	75°29'2"	355



50mm calibration cylinder (optional) code **6316-50**

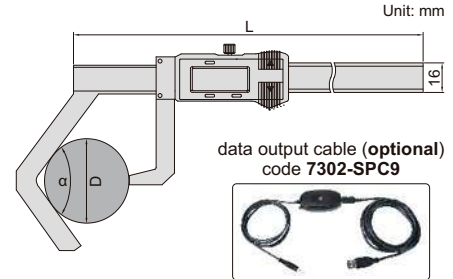

data output cable (optional) code **7302-SPC9**

DIGITAL GEAR TOOTH CALIPERS (NON-WATERPROOF)

- Resolution: 0.01mm/0.0005"
- Carbide tips
- Buttons: zero, on/off, mm/inch
- Automatic power off, move the digital unit to turn on power
- Battery CR2032
- Made of stainless steel

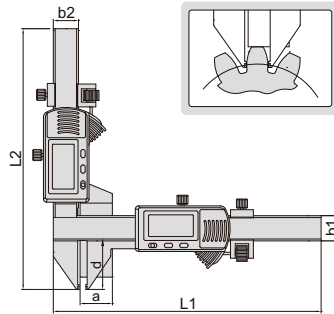

Code	Range	Accuracy	L1	L2	a	b1	b2	d
1181-M25A	M1-25mm	$\pm 0.04\text{mm}$	170	165.5	21	16	16	30.5
1181-M50A	M5-50mm	$\pm 0.04\text{mm}$	220	190	50.5	16	16	55



1181-M25A

ATTENTION: NO DATA OUTPUT

DIGITAL DISK BRAKE CALIPERS (NON-WATERPROOF)

- Measure thickness of disk brakes
- Resolution 0.01mm/0.0005"
- Buttons: on/off, zero, mm/inch
- Automatic power off, move the digital unit to turn on power
- Battery CR2032
- Data output
- Made of stainless steel
- Optional accessory: data output cable (code **7315-**, **7302-**, **7305-**, for calipers without built-in wireless)



1162-125A

RELATIVE PRODUCT: DISK BRAKE MICROMETER (CODE 3288-, 3588-)

DATA OUTPUT

Code	Range	Accuracy	Wireless
1162-125A	0-125mm/0-5"	$\pm 0.05\text{mm}$	no
1162-125AWL			built-in wireless

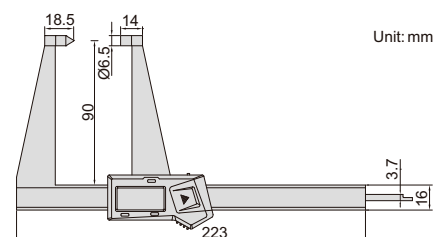

Unit: mm

RELATIVE PRODUCT: DISK BRAKE MICROMETER (CODE 3288-, 3588-)

DATA OUTPUT

DIGITAL DISK BRAKE AND PAD CALIPERS (NON-WATERPROOF)

- Measure thickness of disk brakes and pad wear
- Resolution: 0.01mm/0.0005"
- Buttons: on/off, zero, mm/inch
- Automatic power off, move the digital unit to turn on power
- Battery CR2032
- Data output
- Made of stainless steel
- Optional accessory: data output cable (code 7315-, 7302-, 7305-, for calipers without built-in wireless)



1167-150A

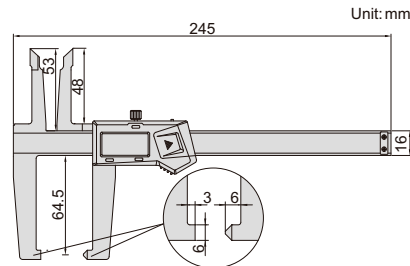

Code	Range	Accuracy	Wireless
1167-150A	0-150mm/0-6"	±0.07mm	no
1167-150AWL			built-in wireless

RELATIVE PRODUCT: DISK BRAKE MICROMETER (CODE 3288-, 3588-)

DATA OUTPUT

DIGITAL DRUM BRAKE CALIPERS (NON-WATERPROOF)

- Measure internal and external diameter of drum brakes
- Resolution 0.01mm/0.0005"
- Buttons: on/off, zero, mm/inch
- Automatic power off, move the digital unit to turn on power
- Battery CR2032
- Data output
- Made of stainless steel
- Optional accessory: data output cable (code 7315-, 7302-, 7305-, for calipers without built-in wireless)



1168-300A

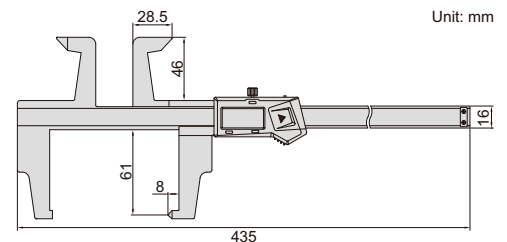

Code	Range	Accuracy	Wireless
1168-300A	0-300mm/0-12"	±0.07mm	no
1168-300AWL			built-in wireless

IP67 WATERPROOF

ATTENTION: NO DATA OUTPUT

ATTENTION: IT IS NECESSARY TO SET ZERO AFTER POWER ON EACH TIME

WATERPROOF DIGITAL DEPTH GAGES

- IP67 dust/waterproof
- Resolution: 0.01mm/0.0005"
- Button function: zero, on/off, mm/inch, ABS/REL, hold
- Meet DIN862
- Battery CR2032
- Made of stainless steel

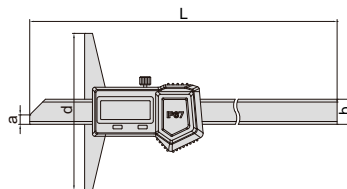

1149-150

Code	Range	Accuracy	L	a	b	d
1149-150	0-150mm/0-6"	±0.03mm	240	6	16	100
1149-200	0-200mm/0-8"	±0.03mm	290	6	16	100
1149-300	0-300mm/0-12"	±0.03mm	390	6	16	150

DIGITAL DEPTH GAGES (STANDARD TYPE, NON-WATERPROOF)

DATA OUTPUT

- Buttons: on/off, zero, mm/inch (except metric type)
- Automatic power off, move the digital unit to turn on power
- Meet DIN862 (except 0-500mm/0-20", 0-1000mm/0-40")
- Battery CR2032, data output
- Made of stainless steel
- Optional accessory: data output cable (code 7315-, 7302-, 7305-, for depth gages without built-in wireless)



1141-150A

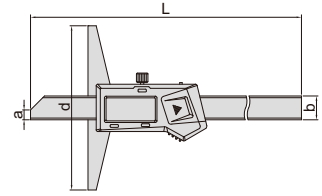

Metric/Inch type

Code	Range	Resolution	Accuracy	L	a	b	d	Wireless
1141-150A	0-150mm/0-6"	0.01mm/0.0005"	±0.03mm	230mm	6mm	14.5mm	100mm	no
1141-150AWL								built-in wireless
1141-200A	0-200mm/0-8"	0.01mm/0.0005"	±0.03mm	280mm	6mm	14.5mm	100mm	no
1141-200AWL								built-in wireless
1141-300A	0-300mm/0-12"	0.01mm/0.0005"	±0.03mm	380mm	6mm	14.5mm	150mm	no
1141-300AWL								built-in wireless
1141-500A	0-500mm/0-20"	0.01mm/0.0005"	±0.05mm	585mm	7mm	15mm	150mm	no
1141-500AWL								built-in wireless
1141-1000A	0-1000mm/0-40"	0.01mm/0.0005"	±0.07mm	1188mm	7mm	18mm	150mm	no
1141-10001A	0-1000mm/0-40"	0.01mm/0.0005"	±0.07mm	1188mm	7mm	18mm	200mm	no
1141-10002A	0-1000mm/0-40"	0.01mm/0.0005"	±0.07mm	1188mm	7mm	18mm	250mm	no
1141-10003A	0-1000mm/0-40"	0.01mm/0.0005"	±0.07mm	1188mm	7mm	18mm	300mm	no

Metric type

Code	Range	Resolution	Accuracy	L	a	b	d	Wireless
1141-150AJ	0-150mm	0.01mm	±0.03mm	230mm	6mm	14.5mm	100mm	no
1141-150AJWL								built-in wireless
1141-200AJ	0-200mm	0.01mm	±0.03mm	280mm	6mm	14.5mm	100mm	no
1141-200AJWL								built-in wireless
1141-300AJ	0-300mm	0.01mm	±0.03mm	380mm	6mm	14.5mm	150mm	no
1141-300AJWL								built-in wireless
1141-500AJ	0-500mm	0.01mm	±0.05mm	585mm	7mm	15mm	150mm	no
1141-500AJWL								built-in wireless

DIGITAL HOOK DEPTH GAGES (NON-WATERPROOF)

DATA OUTPUT

- Resolution: 0.01mm/0.0005"
- Buttons: on/off, zero, mm/inch
- Automatic power off, move the digital unit to turn on power
- Battery CR2032, data output
- Made of stainless steel
- Optional accessory: data output cable (code 7315-, 7302-, 7305-, for depth gages without built-in wireless)



1142-150A

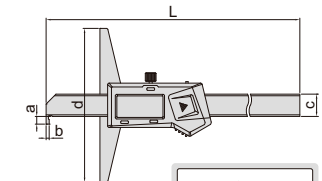

Code	Range	Accuracy	L	d	a	b	c	Wireless
1142-150A	0-150mm/0-6"	±0.03mm	230mm	100mm	5mm	2mm	14.5mm	no
1142-150AWL								built-in wireless
1142-200A	0-200mm/0-8"	±0.03mm	280mm	100mm	5mm	2mm	14.5mm	no
1142-200AWL								built-in wireless
1142-300A	0-300mm/0-12"	±0.04mm	380mm	150mm	5mm	2mm	14.5mm	no
1142-300AWL								built-in wireless
1142-500A	0-500mm/0-20"	±0.05mm	585mm	150mm	8mm	3mm	15mm	no
1142-500AWL								built-in wireless
1142-5001A	0-500mm/0-20"	±0.05mm	585mm	200mm	8mm	3mm	15mm	no
1142-5001AWL	0-500mm/0-20"	±0.05mm	585mm	200mm	8mm	3mm	15mm	built-in wireless
1142-1000A	0-1000mm/0-40"	±0.07mm	1188mm	150mm	10mm	4mm	18mm	no
1142-10001A	0-1000mm/0-40"	±0.07mm	1188mm	200mm	10mm	4mm	18mm	no
1142-10002A	0-1000mm/0-40"	±0.07mm	1188mm	250mm	10mm	4mm	18mm	no

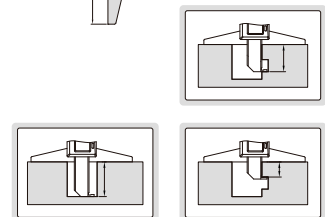

DIGITAL DOUBLE HOOK DEPTH GAGES (NON-WATERPROOF)

- Resolution: 0.01mm/0.0005"
- Buttons: on/off, zero, mm/inch
- Automatic power off, move the digital unit to turn on power
- Meet DIN862
- Battery CR2032, data output
- Made of stainless steel
- Optional accessory: data output cable (code 7315-, 7302-, 7305-, for depth gages without built-in wireless)



1144-150A (mm)

DATA OUTPUT

3

Code	Range	Accuracy	L	d	a	b	c	e	Wireless
1144-150A	0-150mm/0-6"	±0.03mm	233	100	21.5	3.5	14.5	2.5	no
1144-150AWL	0-150mm/0-6"	±0.03mm	233	100	21.5	3.5	14.5	2.5	built-in wireless
1144-200A	0-200mm/0-8"	±0.03mm	283	100	21.5	3.5	14.5	2.5	no
1144-200AWL	0-200mm/0-8"	±0.03mm	283	100	21.5	3.5	14.5	2.5	built-in wireless
1144-300A	0-300mm/0-12"	±0.03mm	383	150	21.5	3.5	14.5	2.5	no
1144-300AWL	0-300mm/0-12"	±0.03mm	383	150	21.5	3.5	14.5	2.5	built-in wireless
1144-500A	0-500mm/0-20"	±0.05mm	585	150	25	5	15	3	no
1144-500AWL	0-500mm/0-20"	±0.05mm	585	150	25	5	15	3	built-in wireless
1144-5001A	0-500mm/0-20"	±0.05mm	585	200	25	5	15	3	no
1144-5001AWL	0-500mm/0-20"	±0.05mm	585	200	25	5	15	3	built-in wireless
1144-1000A	0-1000mm/0-40"	±0.07mm	1188	150	32	7	18	4	no
1144-10001A	0-1000mm/0-40"	±0.07mm	1188	200	32	7	18	4	no
1144-10002A	0-1000mm/0-40"	±0.07mm	1188	250	32	7	18	4	no

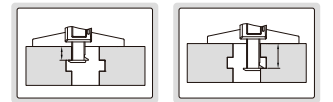
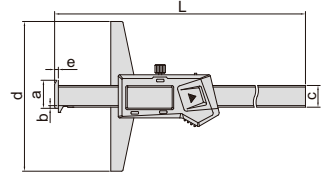

DIGITAL DEPTH GAGES WITH MOUNTING HOLES FOR EXTENSION BASE (NON-WATERPROOF)

- Resolution: 0.01mm/0.0005"
- Buttons: on/off, zero, mm/inch
- Automatic power off, move the digital unit to turn on power
- Meet DIN862
- Battery CR2032, data output
- Made of stainless steel
- Optional accessory: data output cable (code 7315-, 7302-, 7305-, for depth gages without built-in wireless), extension base (code 6141)



1147-300

DATA OUTPUT

Code	Range	Accuracy	L	Wireless
1147-150	0-150mm/0-6"	±0.03mm	237mm	no
1147-150WL	0-150mm/0-6"	±0.03mm	237mm	built-in wireless
1147-200	0-200mm/0-8"	±0.03mm	287mm	no
1147-200WL	0-200mm/0-8"	±0.03mm	287mm	built-in wireless
1147-300	0-300mm/0-12"	±0.03mm	403mm	no
1147-300WL	0-300mm/0-12"	±0.03mm	403mm	built-in wireless
1147-500	0-500mm/0-20"	±0.05mm	605mm	no
1147-500WL	0-500mm/0-20"	±0.05mm	605mm	built-in wireless

extension base (optional)

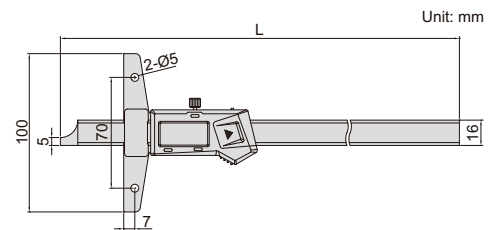

DIGITAL POINT DEPTH GAGES (NON-WATERPROOF)

- Resolution: 0.01mm/0.0005"
- Buttons: on/off, zero, mm/inch
- Automatic power off, move the digital unit to turn on power
- Meet DIN862
- Battery CR2032
- Data output
- Made of stainless steel
- Optional accessory: data output cable (code 7315-, 7302-, 7305-, for depth gages without built-in wireless)



1143-200A

DATA OUTPUT

Code	Range	Accuracy	Wireless
1143-200A	0-200mm/0-8"	±0.03mm	no
1143-200AWL	0-200mm/0-8"	±0.03mm	built-in wireless

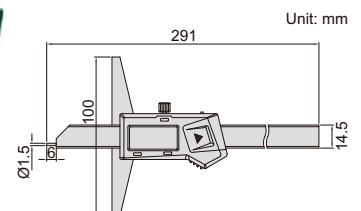
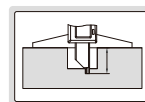

DIGITAL DEPTH GAGES WITH ROUND DEPTH BAR (NON-WATERPROOF)

MEASURE WIDTH AND DEPTH OF GROOVES INSIDE BORE

MEASURE DEPTH OF SMALL HOLES (>Ø4mm)

DATA OUTPUT

preset buttons



3

- Resolution: 0.01mm/0.0005"
- Supplied with three interchangeable points (flat, spherical, disk)
- Buttons: on/off, set, mm/inch, preset (+, -)
- Automatic power off, move the digital unit to turn on power
- Battery CR2032
- Data output
- Made of stainless steel
- Optional accessory: data output cable (code 7315-, 7302-, 7305-, for depth gages without built-in wireless), extension base (code 6141, for 1148-120, 1148-120WL, 1148-200, 1148-200WL, 1148-300 and 1148-300WL)

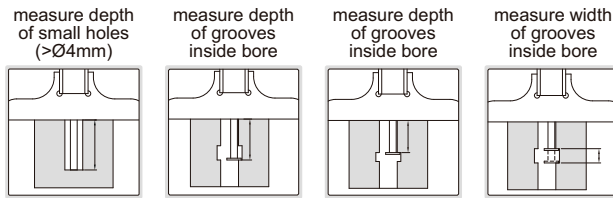
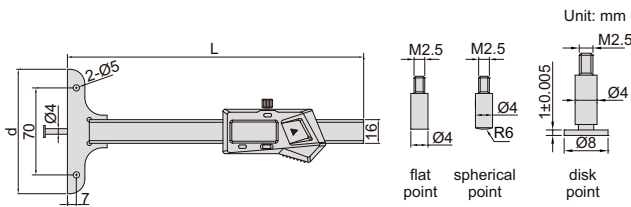

1148-100S



1148-120



1148-200

Code	Range *	Accuracy	L	d	Remark
1148-100S	0-100mm/0-4"	±0.02mm	200	45	no
1148-100SWL					built-in wireless
1148-100	0-100mm/0-4"	±0.02mm	200	85	no
1148-100WL					built-in wireless
1148-120	0-120mm/0-4.7"	±0.03mm	300	101	one-hand use, with mounting holes for extension base
1148-120WL					one-hand use, with mounting holes for extension base, built-in wireless
1148-200	0-200mm/0-8"	±0.03mm	300	101	with mounting holes for extension base
1148-200WL					with mounting holes for extension base, built-in wireless
1148-300	0-300mm/0-12"	±0.04mm	400	101	with mounting holes for extension base
1148-300WL					with mounting holes for extension base, built-in wireless

(mm)

one-hand use of 1148-120 and 1148-120WL



extension base for 1148-120, 1148-120WL, 1148-200, 1148-200WL, 1148-300 and 1148-300WL (optional)



6141 series

1148-P103 (optional), measure width of bottom grooves inside blind hole

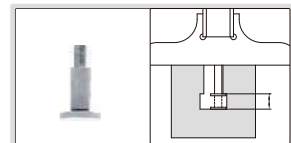

*When disk points are used, the range is reduced by 10mm

OPTIONAL DISK POINTS

Code	Description	H	Remark
1148-P101	0.5mm disk point	0.5±0.005mm	for narrow grooves
1148-P102	0.7mm disk point	0.7±0.005mm	for narrow grooves
1148-P103	1mm disk point	1±0.005mm	for grooves inside blind hole
1148-P104	0.5mm disk point	0.5±0.005mm	for grooves inside blind hole

1148-P101 (optional)

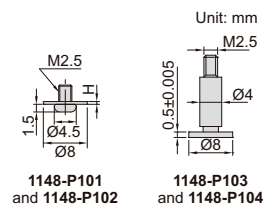

1148-P101 and 1148-P102

1148-P103 and 1148-P104

VERNIER DEPTH GAGES (STANDARD TYPE)

- Made of stainless steel
- Satin chrome plated reading surface

Graduation 0.05mm (mm)

Code	Range	Accuracy	L	d
1240-150	0-150mm	±0.05mm	245	100
1240-200	0-200mm	±0.05mm	282	100
1240-300	0-300mm	±0.08mm	382	100
1240-500	0-500mm	±0.09mm	585	150

Graduation 0.02mm (mm)

Code	Range	Accuracy	L	d
1240-1501	0-150mm	±0.03mm	245	100
1240-2001	0-200mm	±0.03mm	282	100
1240-3001	0-300mm	±0.04mm	382	100
1240-5001	0-500mm	±0.05mm	585	150



1240-2001

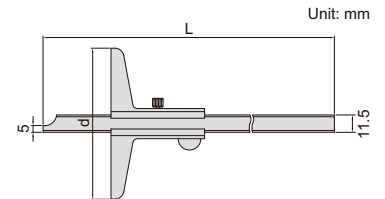

WITH MOUNTING HOLES FOR EXTENSION BASE

extension base (optional)



6141 series

- Made of stainless steel
- Satin chrome plating finish on reading surface
- Optional accessory: extension base (code 6141)

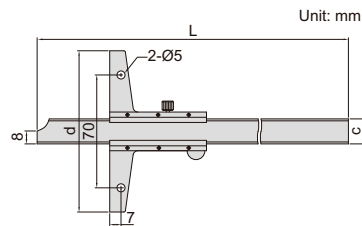

VERNIER DEPTH GAGES



1247-1501

Graduation 0.05mm

Code	Range	Accuracy
1247-150	0-150mm	±0.05mm
1247-200	0-200mm	±0.05mm
1247-300	0-300mm	±0.08mm
1247-600	0-600mm	±0.10mm
1247-1000	0-1000mm	±0.15mm

Graduation 0.02mm

Code	Range	Accuracy
1247-1501	0-150mm	±0.03mm
1247-2001	0-200mm	±0.03mm
1247-3001	0-300mm	±0.04mm
1247-6001	0-600mm	±0.05mm
1247-1001	0-1000mm	±0.07mm

Range	L	c	d
0-150mm	240	11	100
0-200mm	290	11	100
0-300mm	390	11	100
0-600mm	704	16	150
0-1000mm	1124	16	200

WITH MOUNTING HOLES FOR EXTENSION BASE

extension base (optional)



6141 series

- With fine adjustment
- Made of stainless steel
- Satin chrome plating finish on reading surface
- Optional accessory: extension base (code 6141)

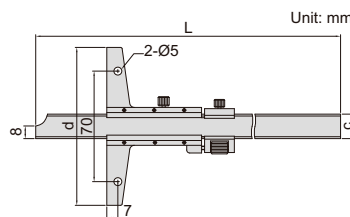

VERNIER DEPTH GAGES WITH FINE ADJUSTMENT



1249-1501

Graduation 0.05mm

Code	Range	Accuracy
1249-150	0-150mm	±0.05mm
1249-200	0-200mm	±0.05mm
1249-300	0-300mm	±0.08mm

Graduation 0.02mm

Code	Range	Accuracy
1249-1501	0-150mm	±0.03mm
1249-2001	0-200mm	±0.03mm
1249-3001	0-300mm	±0.04mm

Range	L	c	d
0-150mm	256	16	100
0-200mm	306	16	100
0-300mm	406	16	100

VERNIER HOOK DEPTH GAGES

WITH MOUNTING HOLES FOR EXTENSION BASE

3

- Made of stainless steel
- Satin chrome plating finish on reading surface
- Optional accessory: extension base (code 6141)



1248-1501

extension base (optional)



6141 series

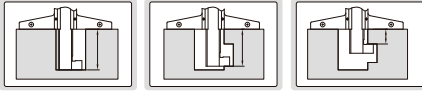

Graduation 0.05mm		(mm)	
Code	Range	Accuracy	L
1248-150	0-150mm	±0.05mm	266
1248-200	0-200mm	±0.05mm	316
1248-300	0-300mm	±0.08mm	416

Graduation 0.02mm		(mm)	
Code	Range	Accuracy	L
1248-1501	0-150mm	±0.03mm	266
1248-2001	0-200mm	±0.03mm	316
1248-3001	0-300mm	±0.04mm	416

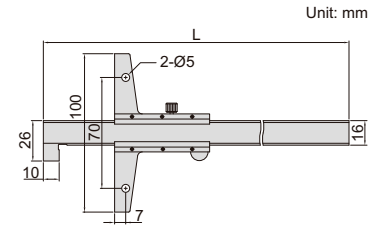

VERNIER HOOK DEPTH GAGE

- Graduation 0.02mm
- Made of stainless steel
- Satin chrome plating finish on reading surface



1243-2001

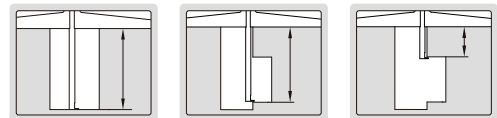
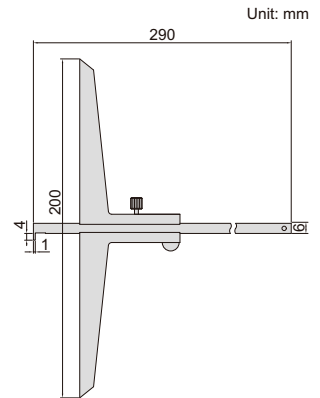

Code	Range	Accuracy
1243-2001	0-200mm	±0.03mm

EXTENSION BASES

- Supplied with two screws
- Made of stainless steel
- Suitable for depth gages series 1147, 1148, 1247, 1248 and 1249



6141-260

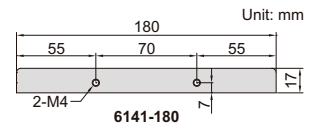

6141-180

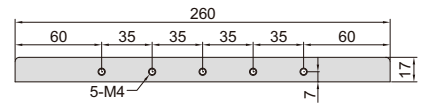

6141-260

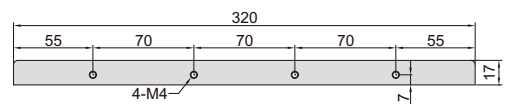

6141-320

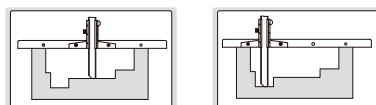

Code	Length
6141-180	180mm
6141-260	260mm
6141-320	320mm

VERNIER DEPTH GAGE (ECONOMIC TYPE)

Unit: mm

- Graduation: 0.1mm
- Made of stainless steel

Code	Range	Accuracy
1244-30	0-30mm	±0.10mm



1244-30

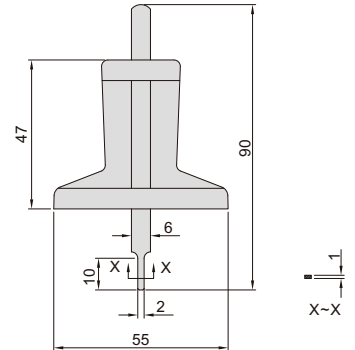

3

DATA OUTPUT

MINI DIGITAL DEPTH GAGES WITH ROUND BAR (NON-WATERPROOF)

- Measure depth of small groove and hole
- Resolution: 0.01mm/0.0005"
- Buttons: on/off, set, mm/inch, preset (+,-)
- Automatic power off, move the digital unit to turn on power
- Battery CR2032
- Data output
- Made of stainless steel
- Optional accessory: data output cable (code 7315-, 7302-, 7305-, for depth gages without built-in wireless)



1140-25

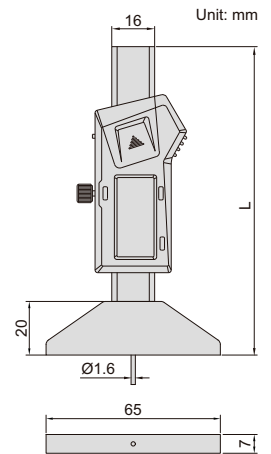

Code	Range	Accuracy	L	Wireless
1140-25	0-25mm/0-1"	±0.02mm	114mm	no
1140-25WL				built-in wireless
1140-50	0-50mm/0-2"	±0.02mm	140mm	no
1140-50WL				built-in wireless

DATA OUTPUT

MINI DIGITAL DEPTH GAGES (NON-WATERPROOF)

- Measure depth of small groove and hole, also measure depth of tire tread
- Resolution: 0.01mm/0.0005"
- Buttons: on/off, zero, mm/inch
- Supplied with zero set surface
- Automatic power off, move the digital unit to turn on power
- Battery CR2032
- Data output
- Made of stainless steel
- Optional accessory: data output cable (code 7315-, 7302-, 7305-, for depth gages without built-in wireless)



1145-25A

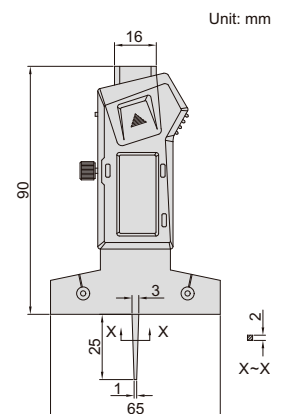

Code	Range	Accuracy	Wireless
1145-25A	0-25mm/0-1"	±0.03mm	no
1145-25AWL			built-in wireless

DIAL DEPTH GAGES

- Accuracy: $\pm 0.017\text{mm}$
- Stainless steel base
- Pointed tip



2343-102

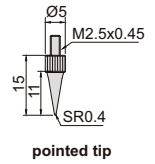
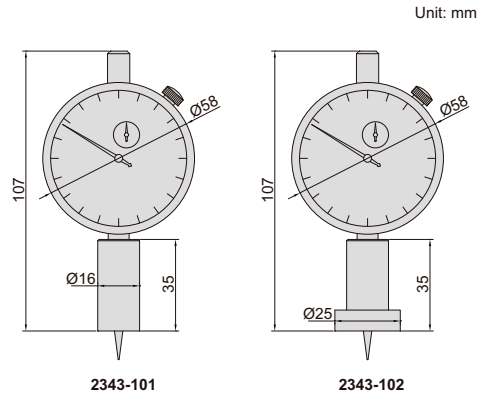

Code	Range	Dial indicator stroke	Dial indicator graduation	Base
2343-101	0-10mm	10mm	0.01mm	Ø16mm
2343-102	0-10mm	10mm	0.01mm	Ø25mm

DIGITAL DEPTH GAGES

DATA OUTPUT

- Button function: on/off, zero, mm/inch, ABS, data preset, change measuring direction
- CR2032 battery, automatic power off
- Data output
- Stainless steel base
- Pointed tip
- Optional accessory: data output cable (code 7315-, 7302-, 7305-)



2142-102

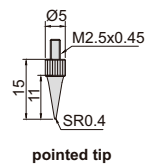
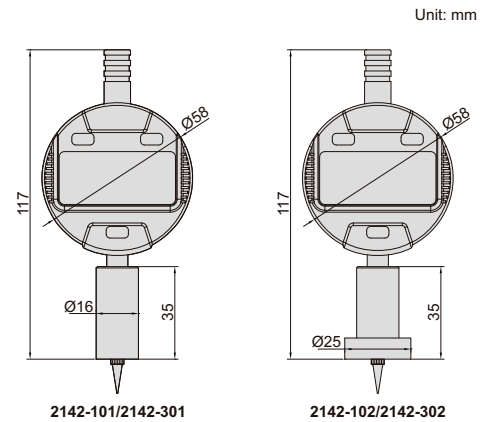

Code	Range	Digital indicator stroke	Digital indicator resolution	Accuracy	Base
2142-101	0-12.7mm/0-0.5"	12.7mm/0.5"	0.01mm/0.0005"	$\pm 20\mu\text{m}$	Ø16mm
2142-102	0-12.7mm/0-0.5"	12.7mm/0.5"	0.01mm/0.0005"	$\pm 20\mu\text{m}$	Ø25mm
2142-301	0-12.7mm/0-0.5"	12.7mm/0.5"	0.001mm/0.00005"	$\pm 5\mu\text{m}$	Ø16mm
2142-302	0-12.7mm/0-0.5"	12.7mm/0.5"	0.001mm/0.00005"	$\pm 5\mu\text{m}$	Ø25mm

DIAL DEPTH GAGE

- Accuracy: $\pm 0.017\text{mm}$
- Stainless steel base
- Supplied with pointed tip and ball tip



2341-101A

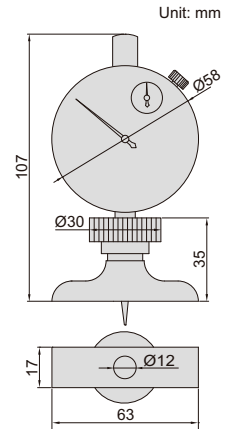
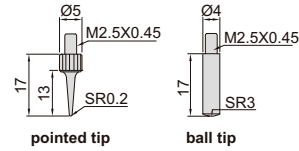

Unit: mm

Code	Range	Dial indicator stroke	Dial indicator graduation
2341-101A	0-10mm	10mm	0.01mm

DIAL DEPTH GAGES



2342-202

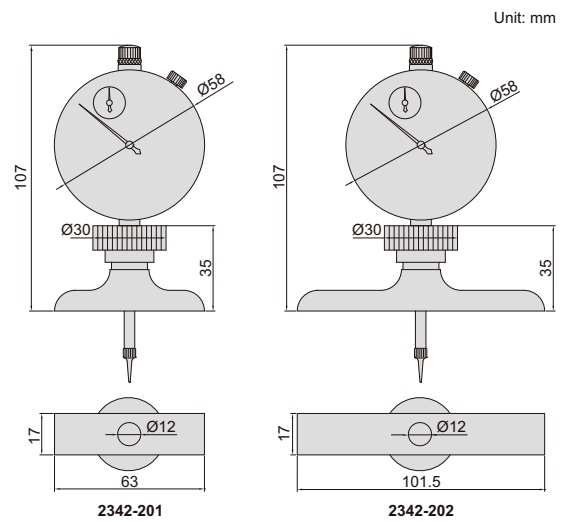

Unit: mm

- Dial indicator graduation: 0.01mm
- Accuracy: $\pm 0.03\text{mm}$
- Stainless steel base
- Extension rods: 25mm (1 pc), 50mm (1 pc), 75mm (1 pc), 100mm (2 pcs)
- Supplied with pointed tip and ball tip

Code	Range	Dial indicator stroke	Base
2342-201	0-300mm	30mm	63x17mm
2342-202	0-300mm	30mm	101.5x17mm

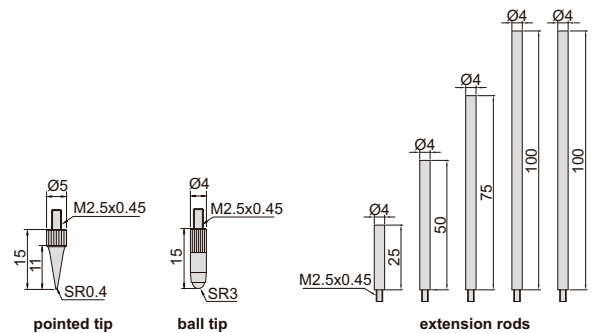

DIGITAL DEPTH GAGES

DATA
OUTPUT

3



2141-202A

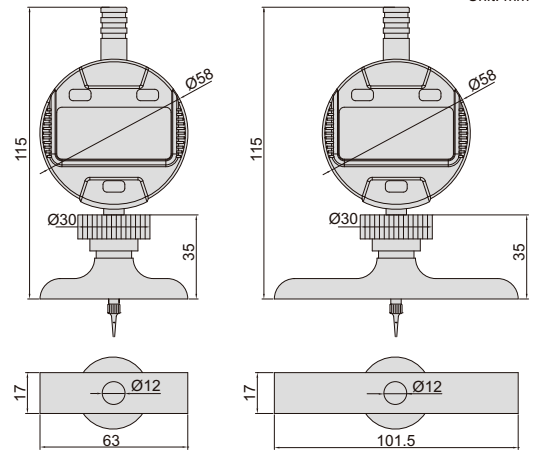

2141-201A/2141-301

2141-202A/2141-302

- Button function: on/off, zero, mm/inch, ABS, data preset, change measuring direction
- CR2032 battery, automatic power off
- Data output
- Stainless steel base
- Extension rods: 12.5mm (1 pc), 25mm (1 pc), 50mm (1 pc), 75mm (1 pc), 100mm (2 pcs)
- Supplied with pointed tip and ball tip
- Optional accessory: data output cable (code 7315-, 7302-, 7305-)

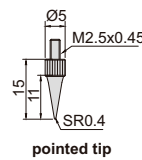

pointed tip

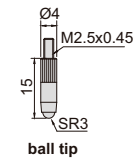

ball tip

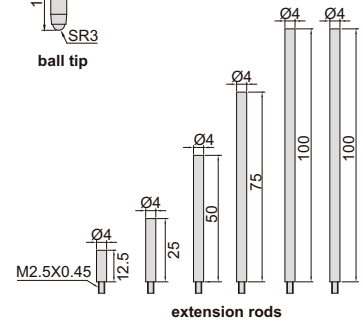

extension rods

Code	Range	Digital indicator stroke	Digital indicator resolution	Accuracy	Base
2141-201A	0-300mm/0-12"	12.7mm/0.5"	0.01mm/0.0005"	±20µm	63x17mm
2141-202A	0-300mm/0-12"	12.7mm/0.5"	0.01mm/0.0005"	±20µm	101.5x17mm
2141-301	0-300mm/0-12"	12.7mm/0.5"	0.001mm/0.00005"	±5µm	63x17mm
2141-302	0-300mm/0-12"	12.7mm/0.5"	0.001mm/0.00005"	±5µm	101.5x17mm

DIGITAL DEPTH GAGE (60° KNIFE EDGE BASE)

DATA
OUTPUT

- Button function: on/off, zero, inch/mm, ABS, data preset, change measuring direction
- CR2032 battery, automatic power off
- Data output
- Stainless steel base with 60° knife edge
- Optional accessory: data output cable (code 7315-, 7302-, 7305-)



front view

side view

2143-101

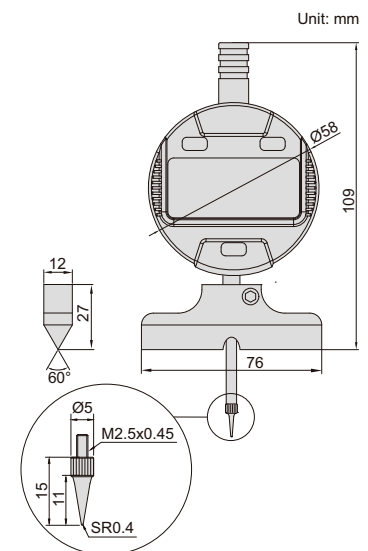

Code	Range	Digital indicator stroke	Digital indicator resolution	Accuracy
2143-101	0-12.7mm/0-0.5"	12.7mm/0.5"	0.01mm/0.0005"	±20µm

IP65
WATERPROOF

DATA
OUTPUT

DIGITAL DEPTH MICROMETERS

3

- Resolution: 0.001mm/0.00005"
- Micrometer head accuracy: $\pm 3\mu\text{m}$
- Rod accuracy: $\pm (2+L/75)\mu\text{m}$, L is the measuring range in mm
- Button function: on/off, set, mm/inch, ABS/INC
- IP65 dust/waterproof
- Data output
- LR44 battery, automatic power off
- Rods with flat end
- Ratchet stop
- Optional accessory: data output cable (code 7315-, 7302-, 7305-)



3540-50

Code	Range	Rods
3540-50	0-50mm/0-2"	2 pcs
3540-150	0-150mm/0-6"	6 pcs
3540-300	0-300mm/0-12"	12 pcs

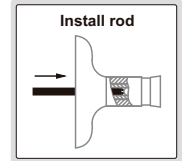
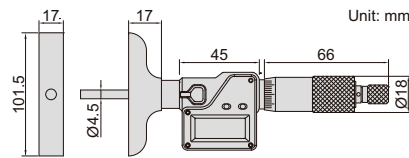

DEPTH MICROMETERS

- Meet DIN863-2
- Graduation: 0.01mm
- Micrometer head accuracy: $\pm 3\mu\text{m}$
- Rod accuracy: $\pm (2+L/75)\mu\text{m}$, L is the measuring range in mm
- Rods with flat end
- Ratchet stop

Code	Range	Rods
3240-25	0-25mm	1 pc
3240-50	0-50mm	2 pcs
3240-75	0-75mm	3 pcs
3240-100	0-100mm	4 pcs
3240-150	0-150mm	6 pcs
3240-200	0-200mm	8 pcs
3240-300	0-300mm	12 pcs



3240-100

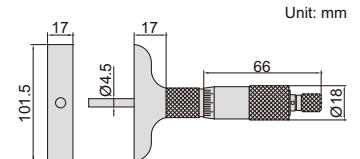
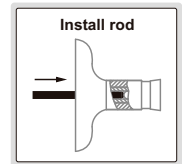

DEPTH MICROMETERS

- Meet DIN863-2
- Graduation: 0.01mm
- Micrometer head accuracy: $\pm 3\mu\text{m}$
- Rod accuracy: $\pm (2+L/75)\mu\text{m}$, L is the measuring range in mm
- Rods with flat end
- Ratchet stop

Base: HxW=101.5x17mm

Code	Range	Rods
3241-25	0-25mm	1 pc
3241-50	0-50mm	2 pcs
3241-75	0-75mm	3 pcs
3241-100	0-100mm	4 pcs
3241-150	0-150mm	6 pcs
3241-200	0-200mm	8 pcs
3241-300	0-300mm	12 pcs



3241-100

Base: HxW=63x17mm

Code	Range	Rods
3241-B25	0-25mm	1 pc

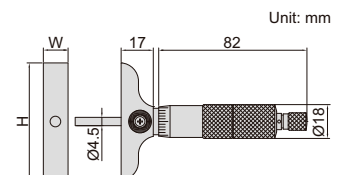
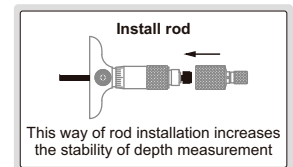

DIGITAL HIGH PRECISION HEIGHT GAGES

4



power supplied by charge pal

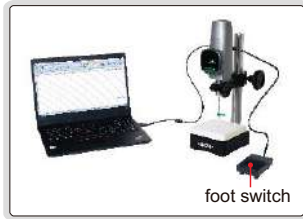

data transmitted to Excel without software

- High stability, high precision, high response speed (5000mm/s)
- High brightness LED display
- Ceramic base flatness: 1µm



1155-505

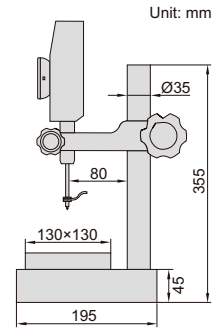

Code	Range	Resolution	Accuracy (20°C)	Measuring force	Output	Power supply
1155-505	0~50mm	0.5µm/0.00002" (can switch to: 1µm/0.00005")	1.5µm	1.0~1.5N	USB	5V/1A (adapter or charge pal)
1155-510	0~50mm	0.1µm/0.000005" (can switch to: 1µm/0.00005")	1µm	1.0~1.5N	USB	5V/1A (adapter or charge pal)

STANDARD DELIVERY

Main unit	1 pc
-----------	------

OPTIONAL ACCESSORY

Contact point	code 6282
Charge pal	1155-5-POB
Data output cables (including foot switch)	1155-5-FOS

DIGITAL HEIGHT GAGES (ECONOMIC TYPE, NON-WATERPROOF)

- Resolution: 0.01mm/0.0005"
- Buttons: on/off, zero, mm/inch, ABS/INC, data hold, TOL, set
- ABS/INC is for absolute and incremental measurement
- TOL is for tolerance measurement
- Carbide tipped scriber
- Made of stainless steel (except the base)
- LR44 battery, data output
- Supplied with dial test indicator holder
- Supplied with dust cover (except 1150-1500/2000)
- Optional accessory: data output cable (code 7302-SPC7, keyboard format)

ATTENTION: CAN NOT USE CLAMP FOR PROTRACTORS (CODE 2372-CLAMP)

ATTENTION: LOW ACCURACY

DATA OUTPUT

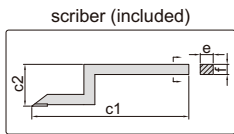

data output cable (optional)



dial test indicator holder (included)

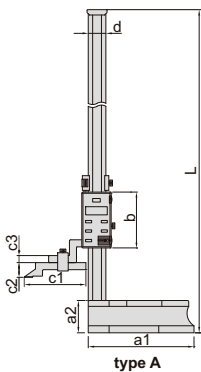
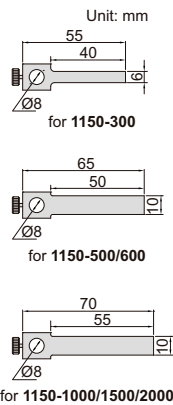

type A

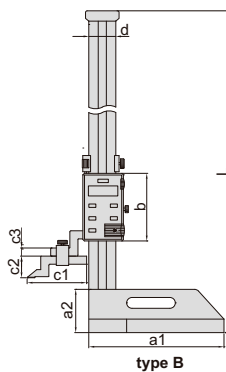

type B



1150-1000



1150-500

Code	Range	Type	Accuracy	L	a1	a2	b	c1	c2	c3	d	e	f
1150-300	0-300mm/0-12"	A	±0.05mm	470mm	135mm	45mm	80mm	76mm	25mm	10mm	23mm	6mm	8mm
1150-500	0-500mm/0-20"	A	±0.06mm	720mm	180mm	55mm	95mm	103mm	25mm	12mm	30mm	10mm	12mm
1150-600	0-600mm/0-24"	A	±0.06mm	820mm	180mm	55mm	95mm	103mm	25mm	12mm	30mm	10mm	12mm
1150-1000	0-1000mm/0-40"	B	±0.08mm	1275mm	250mm	80mm	125mm	110mm	39mm	15mm	50mm	10mm	15mm
1150-1500	0-1500mm/0-60"	B	±0.12mm	1790mm	280mm	80mm	125mm	110mm	39mm	15mm	50mm	10mm	15mm
1150-2000	0-2000mm/0-80"	B	±0.16mm	2290mm	280mm	80mm	125mm	110mm	39mm	15mm	50mm	10mm	15mm

DIGITAL HEIGHT GAGES WITH DRIVING WHEEL (NON-WATERPROOF)

DATA
OUTPUT

- Resolution: 0.01mm/0.0005"
- Buttons: on/off, zero, mm/inch, preset +, preset -, hold
- Automatic power off, move the digital unit to turn on power
- Carbide tipped scriber
- Made of stainless steel
- Battery CR2032
- Data output
- Supplied with dust cover
- With dial test indicator holder
- Optional accessory: data output cable (code 7315-, 7302-, 7305-), clamp for protractors (code 2372-CLAMP)



1156-300

1156-1000

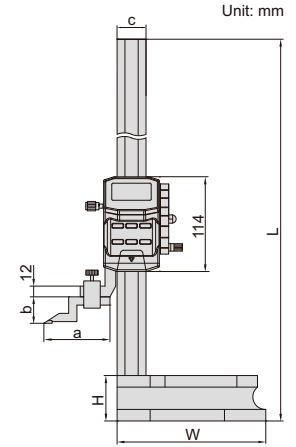

dial test indicator holder (included)

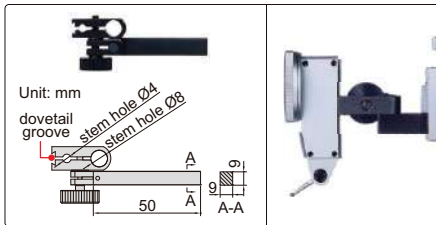

clamp for protractors (optional)

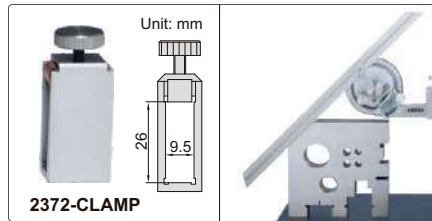

scriber (included)

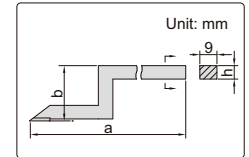

Code	Range	Accuracy	L	W	H	a	b	c	h
1156-300*	0-300mm/0-12"	±0.03mm	515mm	180mm	55mm	80mm	30mm	35mm	9mm
1156-600*	0-600mm/0-24"	±0.05mm	815mm	180mm	55mm	80mm	30mm	35mm	9mm
1156-1000*	0-1000mm/0-40"	±0.07mm	1220mm	265mm	70mm	92mm	48mm	40mm	12mm

*Supplied with manufacturer inspection certificate traceable to DKD Germany

DATA
OUTPUT

ATTENTION: CAN NOT USE CLAMP FOR PROTRACTORS (CODE 2372-CLAMP)

DIGITAL HEIGHT GAGES (NON-WATERPROOF)

- Resolution: 0.01mm/0.0005"
- Buttons: on/off, zero, mm/inch
- Automatic power off, move the digital unit to turn on power
- Carbide tipped scriber
- With fine adjustment
- Made of stainless steel
- Battery CR2032
- Data output
- Optional accessory: data output cable (code 7315-, 7302-, 7305-, for height gages without built-in wireless), dial test indicator holder (code 7151-CL1)

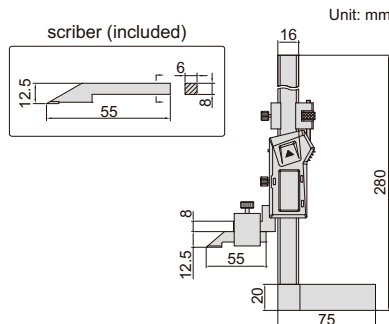

1154-150

dial test indicator holder (optional)

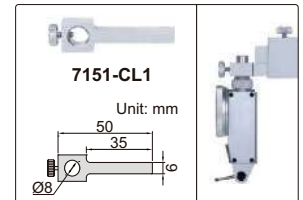

Code	Range	Accuracy	Wireless
1154-150	0-150mm/0-6"	±0.03mm	no
1154-150WL			built-in wireless

DIAL HEIGHT GAGES

dial test indicator holder (included)

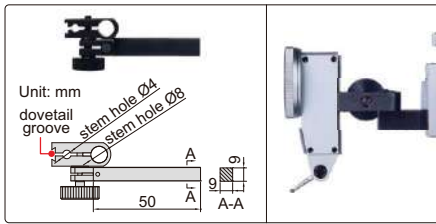

1351-300

scraper (included)

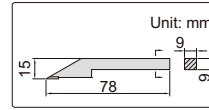

driving wheel on the back

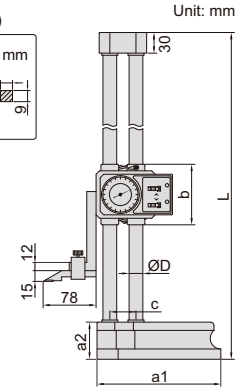

- Dial indicator graduation: 0.01mm
- One counter reads in the plus direction and another in the minus direction, so incremental measurement can be made in either direction
- Carbide tipped scriber
- Made of stainless steel (except the base)
- With driving wheel
- With dial test indicator holder
- Supplied with dust cover
- Optional accessory: clamp for protractors (code 2372-CLAMP)

Code	Range	Accuracy	L	a1	a2	b	c	ØD
1351-300	0-300mm	±0.04mm	475	135	43	84	33	15
1351-450	0-450mm	±0.05mm	660	180	54	88	38	20
1351-600	0-600mm	±0.05mm	810	180	54	88	38	20

clamp for protractors (optional)

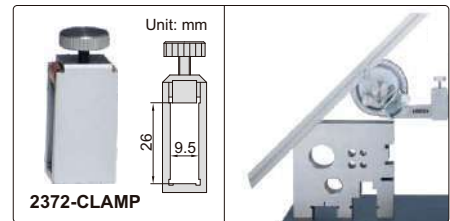

2372-CLAMP

VERNIER HEIGHT GAGES

dial test indicator holder (optional)

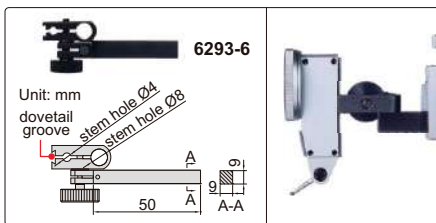

1250-300

scraper (included)

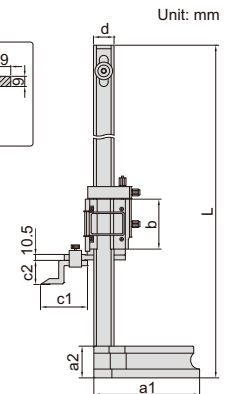
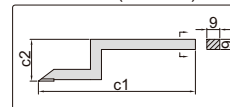

- Graduation: 0.02mm/0.001"
- Adjustable main scale to set zero
- Carbide tipped scriber
- Made of stainless steel (except the base)
- Satin chrome plated scale
- Supplied with magnifier
- With fine adjustment
- Supplied with dust cover
- Optional accessory: dial test indicator holder (code 6293-6), clamp for protractors (code 2372-CLAMP)

Code	Range	Accuracy	L	a1	a2	b	c1	c2	d
1250-300	0-300mm/0-12"	±0.04mm	545	135	43	75	80	30	28
1250-450	0-450mm/0-18"	±0.05mm	720	180	54	85	80	41	35
1250-600	0-600mm/0-24"	±0.05mm	870	180	54	85	80	41	35

clamp for protractors (optional)

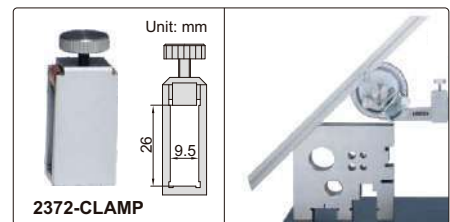

2372-CLAMP

ATTENTION: CAN NOT USE CLAMP FOR PROTRACTORS (CODE 2372-CLAMP)

VERNIER HEIGHT GAGES

- Graduation 0.02mm/0.001"
- Carbide tipped scriber
- Made of stainless steel (except the base)
- Satin chrome plated scale
- Optional accessory: dial test indicator holder (code 7151-CL1)

dial test indicator holder (optional)

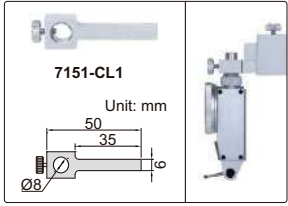

1253-200

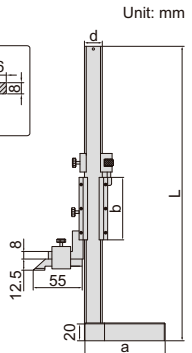
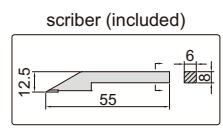

Code	Range	Accuracy	L	a	b	d
1253-150	0-150mm/0-6"	±0.03mm	265	75	57	16
1253-200	0-200mm/0-8"	±0.03mm	325	90	70	20

SCRIBERS FOR HEIGHT GAGES

- Carbide tipped



7150-SC1

Code	For height gages	Type	c1	c2	D	E
7150-SC1	1150-300	A	76mm	25mm	6mm	8mm
7150-SC2	1150-500, 1150-600	A	103mm	25mm	10mm	12mm
7150-SC3	1150-1000, 1150-1500, 1150-2000	A	110mm	39mm	10mm	15mm
7150-SC4	1351-300, 1351-450, 1351-600	B	78mm	15mm	9mm	9mm
7150-SC6	1250-300, 1156-300, 1156-600	A	80mm	30mm	9mm	9mm
7150-SC7	1250-450, 1250-600	A	80mm	41mm	9mm	9mm
7150-SC9	1253-150, 1253-200, 1154-150	B	55mm	12.5mm	6mm	8mm
7150-SC10	1156-1000	A	92mm	48mm	9mm	12mm

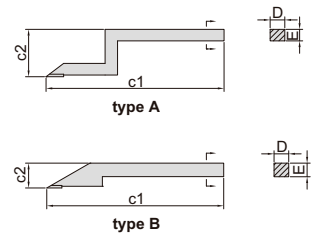

DATA OUTPUT

MINI DIGITAL HEIGHT GAGES (NON-WATERPROOF)

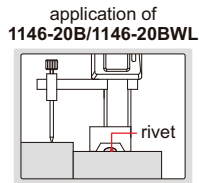
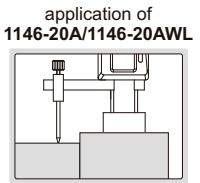

- Measure height difference of two surfaces (1146-20B, 1146-20BWL suitable for surfaces with barrier, such as rivet)
- Resolution: 0.01mm/0.0005"
- Buttons: on/off, zero, mm/inch
- Automatic power off, move the digital unit to turn on power
- Battery CR2032
- Data output
- Made of stainless steel
- Optional accessory: data output cable (code 7315-, 7302-, 7305-, for height gages without built-in wireless)



1146-20A



1146-20B

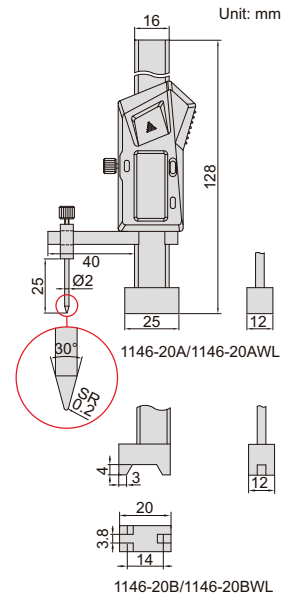

Code	Range	Accuracy	Wireless
1146-20A	0~±20mm/0~±0.8"	±0.02mm	no
1146-20AWL			built-in wireless
1146-20B	0~±20mm/0~±0.8"	±0.02mm	no
1146-20BWL			built-in wireless

HIGH PRECISION NON-ROTATING SPINDLE DIGITAL MICROMETERS

INSIZE PLUS
MADE IN GERMANY

NON-ROTATING
SPINDLE

STROKE
30mm

DATA
OUTPUT

ATTENTION: SETTING
STANDARDS ARE NOT INCLUDED

IP65
WATERPROOF

QUICK MEASUREMENT
ONE TURN OF SLEEVE OR RATCHET
STOP MAKES 2MM SPINDLE FEED

5

- Resolution: 0.01mm/0.0005", 0.001mm/0.00005", 0.0005mm/0.00002"
- Repeatability: 0.5µm
- Measuring force: 5-10N
- Flatness of measuring faces: 0.3µm
- Parallelism of measuring faces: 0.5µm
- Ratchet stop
- Non-rotating spindle, suitable for cylinders
- Quick measurement: one turn of sleeve or ratchet stop makes 2mm spindle feed
- Carbide measuring faces
- Data output
- Button function: mm/inch, max./min. value tracking, preset value, hold, on/off, zero
- CR2032 battery
- Automatic power off, turn the sleeve to turn on
- Optional accessory: setting standards (code 7386), data output cable (code 7305-A03, 7305-SPC4)



3661-30

Code	Range	Accuracy	L	a	b
3661-30	0-30mm/0-1.18"	±2µm	38	169	24
3661-55	25-55mm/.98-2.17"	±2µm	63	195	30.5
3661-80	50-80mm/1.97-3.15"	±3µm	88	228	44
3661-105	75-105mm/2.95-4.13"	±3µm	113	257	57
3661-130	100-130mm/3.94-5.12"	±3µm	138	289	70
3661-155	125-155mm/4.92-6.1"	±3µm	163	315	83
3661-180	150-180mm/5.91-7.09"	±4µm	188	340	96
3661-205	175-205mm/6.89-8.07"	±4µm	213	363	109

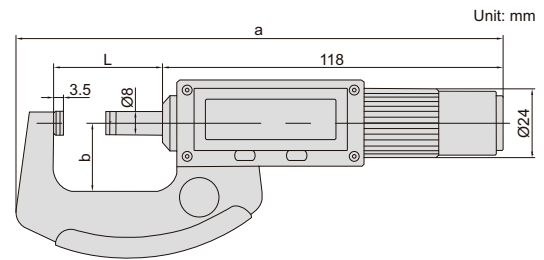

Unit: mm

INDICATING MICROMETER

INSIZE PLUS
MADE IN GERMANY

ATTENTION: SETTING
STANDARDS ARE NOT INCLUDED

INSPECTION
CERTIFICATE
TRACEABLE TO DKD



3333-25

- Meet DIN863-3
- Carbide measuring faces
- The dial can be rotated
- Measuring force 5-10N
- Optional accessory: gage blocks grade 0 (4101-A series), for zero setting

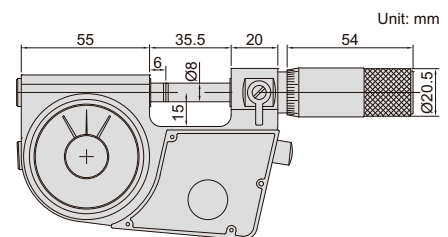

Unit: mm

Code	Micrometer head			Dial indicator		
	Range	Graduation	Accuracy	Range	Graduation	Accuracy
3333-25*	0-25mm	0.01mm	4µm	±0.07mm	1µm	±1µm

* Supplied with manufacturer inspection certificate traceable to DKD Germany

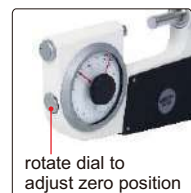

MICROMETERS WITH DIAL INDICATOR

- Meet DIN863-3
- Micrometer head graduation: 0.01mm
- Adjust collars for different measuring ranges
- Anvil retracting range: 3mm
- Carbide measuring faces
- Optional accessory: dial indicators or digital indicators, setting standards (code 7386)



Code	Range	Micrometer head range	Frame type	L	b
3633-100 *	0-100mm	25mm	steel plate	116mm	65mm
3633-200 *	100-200mm	25mm	steel plate	217mm	109mm
3633-300 *	200-300mm	25mm	steel plate	317mm	159mm
3633-400	300-400mm	25mm	steel plate	417mm	209mm
3633-500	400-500mm	25mm	steel tube	517mm	259mm
3633-600	500-600mm	25mm	steel tube	617mm	310mm
3633-700	600-700mm	25mm	steel tube	717mm	360mm
3633-800	700-800mm	25mm	steel tube	817mm	408mm
3633-900	800-900mm	25mm	steel tube	917mm	460mm
3633-1000	900-1000mm	25mm	steel tube	1017mm	512mm

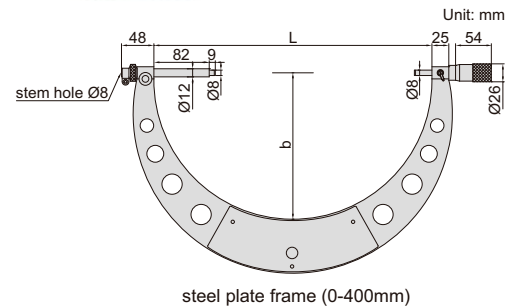

*Supplied with manufacturer inspection certificate traceable to DKD Germany

EXTERNAL SCREW THREAD MICROMETERS

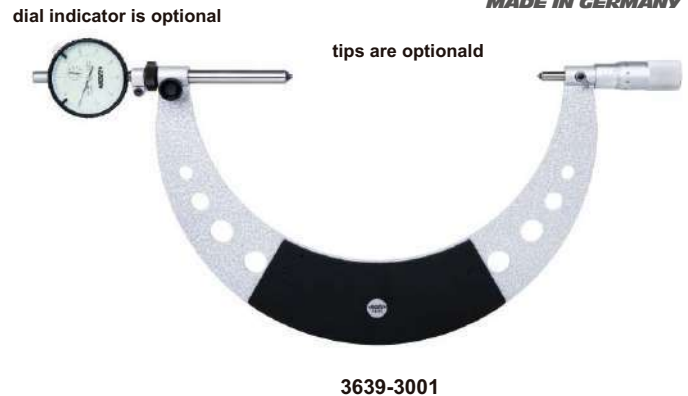
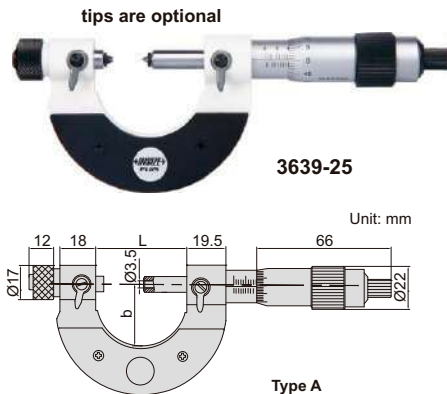

- Meet DIN863-3
- Measure pitch diameter of screw thread
- Graduation 0.01mm
- Optional accessory: measuring tips and setting standards for external screw thread micrometer (code 7384), dial indicators or digital indicators (reading 0.01mm or 0.001mm) (only for type B)

Type A (ratchet thimble)

Code	Range	Accuracy	L	b
3639-25 *	0-25mm	4µm	45mm	31mm
3639-50 *	25-50mm	4µm	70mm	35mm
3639-75 *	50-75mm	5µm	95mm	48.5mm
3639-100 *	75-100mm	5µm	120mm	60mm
3639-125 *	100-125mm	6µm	145mm	72.5mm
3639-150 *	125-150mm	6µm	170mm	80mm
3639-175 *	150-175mm	7µm	195mm	97.5mm
3639-200 *	175-200mm	7µm	220mm	110mm
3639-225 *	200-225mm	8µm	245mm	122mm

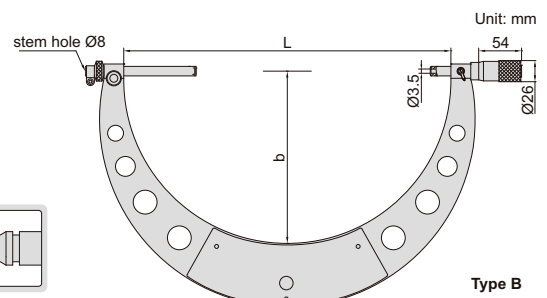

Type B (without ratchet thimble)

Code	Range	Anvil retracting range	L	b
3639-2001 *	100-200mm	3mm	217mm	109mm
3639-3001 *	200-300mm	3mm	317mm	159mm
3639-4001 *	300-400mm	3mm	417mm	209mm

*Supplied with manufacturer inspection certificate traceable to DKD Germany

MEASURING TIPS FOR EXTERNAL SCREW THREAD MICROMETERS

INSIZE PLUS
MADE IN GERMANY

TIPS FOR TRAPEZOIDAL, ACME
THREAD ARE ALSO AVAILABLE

- Supplied in pair
- Made of hardened steel
- Suitable for 3639 series micrometers



7384-T108



ATTENTION: WHEN PITCH <0.4MM OR >63.5 TPI,
SETTING STANDARDS CANNOT BE USED TO SET ZERO,
A CALIBRATED WORK PIECE CAN BE USED INSTEAD

5

60° thread angle

Code	Applicable pitch (mm)
7384-T101	0.2
7384-T102	0.225
7384-T103	0.25
7384-T104	0.3
7384-T105	0.35
7384-T106	0.4/0.45
7384-T107	0.5/0.6

60° thread angle

Code	Applicable pitch (mm)
7384-T108	0.7/0.75/0.8
7384-T109	1/1.25
7384-T110	1.5/1.75
7384-T111	2.0/2.5
7384-T112	3.0/3.5
7384-T113	4.0/4.5/5.0
7384-T114	5.5/6.0

55° thread angle

Code	Applicable pitch (TPI)
7384-T201	80
7384-T202	72/64
7384-T203	60/48
7384-T204	40/32
7384-T205	28/26/24/22
7384-T206	20/19/18/16

55° thread angle

Code	Applicable pitch (TPI)
7384-T207	14/12/11
7384-T208	10/9/8
7384-T209	7/6
7384-T210	5/4.5/4
7384-T211	3.5/3.25/3/2.875/2.75
7384-T212	2.625/2.5/2

SETTING STANDARDS FOR EXTERNAL SCREW THREAD MICROMETERS



7384-A100



60° thread angle

Code	L	Accuracy
7384-A25	25mm	±1.5µm
7384-A50	50mm	±2µm
7384-A75	75mm	±2.5µm
7384-A100	100mm	±3µm
7384-A125	125mm	±3.5µm
7384-A150	150mm	±4µm

Code	L	Accuracy
7384-A175	175mm	±4.5µm
7384-A200	200mm	±5µm
7384-A225	225mm	±5.5µm
7384-A250	250mm	±6µm
7384-A275	275mm	±6.5µm
7384-A300	300mm	±7µm

55° thread angle

Code	L	Accuracy
7384-B25	25mm	±1.5µm
7384-B50	50mm	±2µm
7384-B75	75mm	±2.5µm
7384-B100	100mm	±3µm
7384-B125	125mm	±3.5µm
7384-B150	150mm	±4µm

Code	L	Accuracy
7384-B175	175mm	±4.5µm
7384-B200	200mm	±5µm
7384-B225	225mm	±5.5µm
7384-B250	250mm	±6µm
7384-B275	275mm	±6.5µm
7384-B300	300mm	±7µm

MEASURING TIPS FOR INTERNAL SCREW THREAD MICROMETERS

INSIZE PLUS
MADE IN GERMANY

TIPS FOR TRAPEZOIDAL, ACME
THREAD ARE ALSO AVAILABLE

- Supplied in pair
- Made of hardened steel
- Suitable for 3640, 3641 series micrometers



7385-T106A

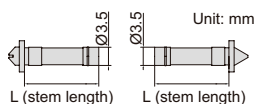

7385-T106B

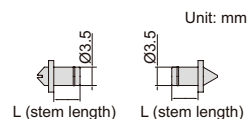

60° thread angle

Code		Applicable pitch (mm)
L=13.5mm	L=5mm	
7385-T101A	7385-T101B	0.35
7385-T102A	7385-T102B	0.4/0.45
7385-T103A	7385-T103B	0.5/0.6
7385-T104A	7385-T104B	0.7/0.75/0.8
7385-T105A	7385-T105B	1/1.25
7385-T106A	7385-T106B	1.5/1.75
7385-T107A	7385-T107B	2.0/2.5
7385-T108A	7385-T108B	3.0/3.5
7385-T109A	7385-T109B	4.0/4.5/5.0
7385-T110A	7385-T110B	5.5/6.0

55° thread angle

Code		Applicable pitch (TPI)
L=13.5mm	L=5mm	
7385-T201A	7385-T201B	60/48
7385-T202A	7385-T202B	40/32
7385-T203A	7385-T203B	28/26/24/22
7385-T204A	7385-T204B	20/19/18/16
7385-T205A	7385-T205B	14/12/11
7385-T206A	7385-T206B	10/9/8
7385-T207A	7385-T207B	7/6
7385-T208A	7385-T208B	5/4.5/4
7385-T209A	7385-T209B	3.5/3.25/3/2.875/2.75
7385-T210A	7385-T210B	2.625/2.5/2

BALL TIPS FOR GEAR TOOTH MICROMETERS

INSIZE PLUS
MADE IN GERMANY

- Supplied in pair
- Made of hardened special steel
- Suitable for **3636**, **3637**, **3638** series micrometers



7383-8

Code	Ball dia. (D)	Accuracy of D	d
7383-1	SØ1mm	±1µm	Ø3mm
7383-2	SØ2mm	±1µm	Ø3mm
7383-3	SØ3mm	±1µm	Ø3mm
7383-4	SØ4mm	±1µm	Ø3mm
7383-5	SØ5mm	±1µm	Ø3mm
7383-6	SØ6mm	±1µm	Ø3mm
7383-7	SØ7mm	±1µm	Ø3mm
7383-8	SØ8mm	±1µm	Ø3mm

Code	Ball dia. (D)	Accuracy of D	d
7383-9	SØ9mm	±1µm	Ø3mm
7383-10	SØ10mm	±1µm	Ø3mm
7383-11	SØ11mm	±1µm	Ø3mm
7383-12	SØ12mm	±1µm	Ø3mm
7383-13	SØ13mm	±1µm	Ø3mm
7383-14	SØ14mm	±1µm	Ø3mm
7383-15	SØ15mm	±1µm	Ø3mm
7383-16	SØ16mm	±1µm	Ø3mm



EXTERNAL GEAR TOOTH MICROMETERS

INSIZE PLUS
MADE IN GERMANY

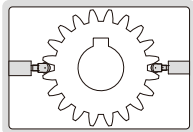

- Meet DIN863-3
- Measure over-pin diameter of gears
- Graduation 0.01mm
- Ratchet stop
- Optional accessory: ball tips (code **7383**)

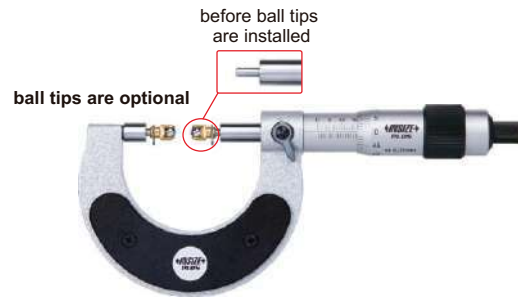

3636-25

Code	Range	Accuracy	L	b
3636-25 *	0-25mm	4µm	56mm	40mm
3636-50 *	25-50mm	4µm	81.5mm	52mm
3636-75 *	50-75mm	5µm	106.5mm	64.5mm
3636-100 *	75-100mm	5µm	131.5mm	76mm
3636-125 *	100-125mm	6µm	156.5mm	88.5mm
3636-150 *	125-150mm	6µm	181.5mm	100mm
3636-175 *	150-175mm	7µm	242.5mm	121.5mm
3636-200 *	175-200mm	7µm	242.5mm	121.5mm
3636-225 *	200-225mm	8µm	267.5mm	134mm
3636-250 *	225-250mm	8µm	292.5mm	146.5mm
3636-275 *	250-275mm	9µm	318mm	159mm
3636-300 *	275-300mm	9µm	342.5mm	171.5mm
3636-325 *	300-325mm	10µm	367.5mm	184mm
3636-350 *	325-350mm	10µm	392.5mm	196.5mm
3636-375 *	350-375mm	11µm	417.5mm	209mm

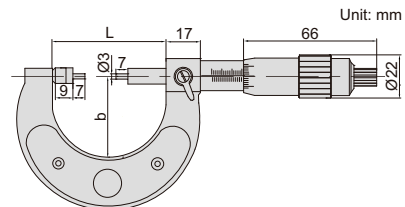

* Supplied with manufacturer inspection certificate traceable to DKD Germany

DIGITAL OUTSIDE MICROMETERS (WITH DATA OUTPUT)



DATA
OUTPUT

IP65
WATERPROOF

5

- IP65 dust/waterproof
- Button function: on/off, set, mm/inch, ABS/INC
- Data output
- LR44 battery, automatic power off
- Carbide measuring faces
- Supplied with spherical anvil
- Setting standards are included (except 0-25mm/0-1")
- Optional accessory: data output cable (code 7315-, 7302-, 7305-)

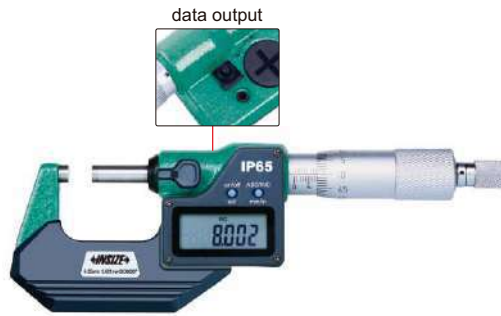

3101-25A

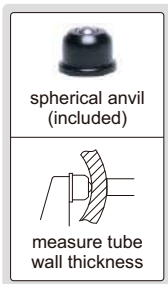
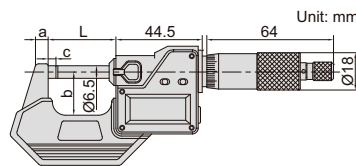

Metric/Inch type (ratchet stop)

(mm)

Code	Range	Resolution	Accuracy	L	a	b	c
3101-25A*	0-25mm/0-1"	0.001mm/0.00005"	±2µm	34.5	6	25	3
3101-50A*	25-50mm/1-2"	0.001mm/0.00005"	±2µm	59.5	8	32	3
3101-75A*	50-75mm/2-3"	0.001mm/0.00005"	±3µm	84.5	8	44.5	3
3101-100A*	75-100mm/3-4"	0.001mm/0.00005"	±3µm	109.5	8	57	3
3101-125A	100-125mm/4-5"	0.001mm/0.00005"	±3µm	135	10	70	3
3101-150A	125-150mm/5-6"	0.001mm/0.00005"	±3µm	160.5	10	82	3
3101-175A	150-175mm/6-7"	0.001mm/0.00005"	±4µm	186	12	94.5	5.5
3101-200A	175-200mm/7-8"	0.001mm/0.00005"	±4µm	211.5	12	107	5.5
3101-225A	200-225mm/8-9"	0.001mm/0.00005"	±4µm	236	23	129.5	5.5
3101-250A	225-250mm/9-10"	0.001mm/0.00005"	±4µm	261.5	23	142.5	5.5
3101-275A	250-275mm/10-11"	0.001mm/0.0001"	±5µm	287	23	155	5.5
3101-300A	275-300mm/11-12"	0.001mm/0.0001"	±5µm	312.5	23	167.5	5.5

Metric/Inch type (friction thimble)

(mm)

Code	Range	Resolution	Accuracy	L	a	b	c
3101-25FA*	0-25mm/0-1"	0.001mm/0.00005"	±2µm	34.5	6	25	3

Metric type (ratchet stop)

(mm)

Code	Range	Resolution	Accuracy	L	a	b	c
3101-25AJ*	0-25mm	0.001mm	±2µm	34.5	6	25	3
3101-50AJ*	25-50mm	0.001mm	±2µm	59.5	8	32	3
3101-75AJ*	50-75mm	0.001mm	±3µm	84.5	8	44.5	3
3101-100AJ*	75-100mm	0.001mm	±3µm	109.5	8	57	3

Set (ratchet stop type)

Code	Range	Micrometers included	Packaging
3101-753A*	0-75mm/0-3"	3101-25A, 3101-50A, 3101-75A	blow mould case
3101-1004A*	0-100mm/0-4"	3101-25A, 3101-50A, 3101-75A, 3101-100A	blow mould case
3101-1506A	0-150mm/0-6"	3101-25A, 3101-50A, 3101-75A, 3101-100A, 3101-125A, 3101-150A	aluminum box



3101-753A



3101-1506A

* Supplied with manufacturer inspection certificate traceable to DKD Germany

- Resolution 0.001mm/0.0005"
- IP65 dust/waterproof
- Button function: on/off, set, mm/inch, ABS/INC
- No data output
- LR44 battery, automatic power off
- Carbide measuring faces
- Supplied with spherical anvil
- Setting standards are included (except 0-25mm/0-1")

IP65
WATERPROOF

ATTENTION: NO DATA OUTPUT

DIGITAL OUTSIDE MICROMETERS (WITHOUT DATA OUTPUT)

INSPECTION CERTIFICATE
TRACEABLE TO DKD

Ratchet stop type

Code	Range	Accuracy	L	a	b	c
3108-25A*	0-25mm/0-1"	±2µm	34.5	6	25	3
3108-50A*	25-50mm/1-2"	±2µm	59.5	8	32	3
3108-75A*	50-75mm/2-3"	±3µm	84.5	8	44.5	3
3108-100A*	75-100mm/3-4"	±3µm	109.5	8	57	3
3108-125A	100-125mm/4-5"	±3µm	135	10	70	3
3108-150A	125-150mm/5-6"	±3µm	160.5	10	82	3
3108-175A	150-175mm/6-7"	±4µm	186	12	94.5	5.5
3108-200A	175-200mm/7-8"	±4µm	211.5	12	107	5.5

Friction thimble type

Code	Range	Accuracy	L	a	b	c
3108-25FA*	0-25mm/0-1"	±2µm	34.5	6	25	3

Set

Code	Range	Micrometers included	Packaging
3108-753A*	0-75mm/0-3"	3108-25A, 3108-50A, 3108-75A	blow mould case
3108-1004A*	0-100mm/0-4"	3108-25A, 3108-50A, 3108-75A, 3108-100A	blow mould case
3108-1506A	0-150mm/0-6"	3108-25A, 3108-50A, 3108-75A, 3108-100A, 3108-125A, 3108-150A	aluminum box

*Supplied with manufacturer inspection certificate traceable to DKD Germany



without data output

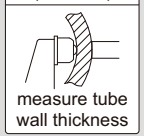
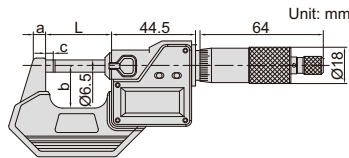

ATTENTION: NO DATA OUTPUT

DIGITAL OUTSIDE MICROMETERS (BASIC TYPE, WITHOUT DATA OUTPUT)

- Resolution 0.001mm/0.0005"
- Button function: on/off, set, mm/inch, ABS/INC
- No data output
- LR44 battery, automatic power off
- Carbide measuring faces
- Friction thimble
- Supplied with spherical anvil
- Setting standards are included (except 0-25mm/0-1")

Code	Range	Accuracy	L	a	b
3109-25A*	0-25mm/0-1"	±2µm	32	6	27.5
3109-50A*	25-50mm/1-2"	±2µm	57	8	37
3109-75A*	50-75mm/2-3"	±3µm	82	8	50
3109-100A*	75-100mm/3-4"	±3µm	107	10	61
3109-125A	100-125mm/4-5"	±3µm	132	10	73
3109-150A	125-150mm/5-6"	±3µm	157	10	85
3109-175A	150-175mm/6-7"	±4µm	182	21	104
3109-200A	175-200mm/7-8"	±4µm	207	21	117

Set

Code	Range	Micrometers included	Packaging
3109-753A*	0-75mm/0-3"	3109-25A, 3109-50A, 3109-75A	blow mould case
3109-1004A*	0-100mm/0-4"	3109-25A, 3109-50A, 3109-75A, 3109-100A	blow mould case
3109-1506A	0-150mm/0-6"	3109-25A, 3109-50A, 3109-75A, 3109-100A, 3109-125A, 3109-150A	aluminum box

*Supplied with manufacturer inspection certificate traceable to DKD Germany

without data output



INSPECTION CERTIFICATE
TRACEABLE TO DKD

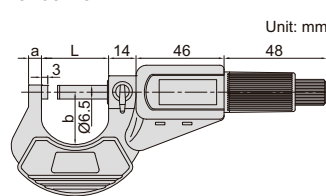
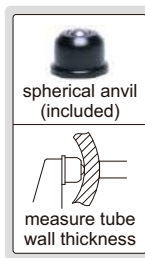

DIGITAL OUTSIDE MICROMETERS (BASIC TYPE, WITH DATA OUTPUT)

- Resolution 0.001mm/0.00005"
- Button function: on/off, set, mm/inch, ABS/INC
- Data output
- LR44 battery, automatic power off
- Carbide measuring faces
- Friction thimble
- Supplied with spherical anvil
- Setting standards are included (except 0-25mm/0-1")
- Optional accessory: data output cable (code 7315-, 7302-, 7305-)

INSPECTION CERTIFICATE
TRACEABLE TO DKD

DATA OUTPUT



3102-25

Code	Range	Accuracy	L	a	b
3102-25 *	0-25mm/0-1"	±2µm	32	6	27.5
3102-50 *	25-50mm/1-2"	±2µm	57	8	37
3102-75 *	50-75mm/2-3"	±3µm	82	8	50
3102-100 *	75-100mm/3-4"	±3µm	107	10	61
3102-125	100-125mm/4-5"	±3µm	132	10	73
3102-150	125-150mm/5-6"	±3µm	157	10	85
3102-175	150-175mm/6-7"	±4µm	182	21	104
3102-200	175-200mm/7-8"	±4µm	207	21	117

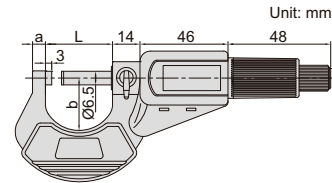
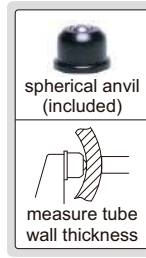

Set

Code	Range	Micrometers included	Packaging
3102-753A *	0-75mm/0-3"	3102-25, 3102-50, 3102-75	blow mould case
3102-1004A *	0-100mm/0-4"	3102-25, 3102-50, 3102-75, 3102-100	blow mould case
3102-1506A	0-150mm/0-6"	3102-25, 3102-50, 3102-75, 3102-100, 3102-125, 3102-150	aluminum box



3102-753

3102-1506

*Supplied with manufacturer inspection certificate traceable to DKD Germany

OUTSIDE MICROMETERS WITH COUNTER

- Counter resolution: 0.01mm
- Thimble graduation: 0.01mm
- Carbide measuring faces
- Meet DIN 863-1
- Ratchet stop
- Supplied with setting standards (except 0-25mm)

INSPECTION CERTIFICATE
TRACEABLE TO DKD

Code	Range	Accuracy	L	a	b
3400-25 *	0-25mm	4µm	32mm	6mm	26mm
3400-50 *	25-50mm	4µm	57mm	8mm	32mm
3400-75 *	50-75mm	5µm	82mm	8mm	44.5mm
3400-100 *	75-100mm	5µm	107mm	8mm	57mm



3400-25

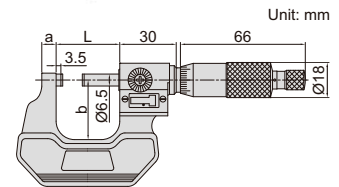

*Supplied with manufacturer inspection certificate traceable to DKD Germany

QUICK FEEDING OUTSIDE MICROMETERS

- Graduation 0.01mm
- 1mm feeding of each turn
- Friction thimble
- Carbide measuring faces
- Meet DIN863-1
- Supplied with setting standards (except 0-25mm)

Code	Range	Accuracy	L	a	b
3208-25B	0-25mm	4µm	32mm	6mm	24mm
3208-50B	25-50mm	4µm	57mm	8mm	32mm
3208-75B	50-75mm	5µm	82mm	8mm	45mm
3208-100B	75-100mm	5µm	107mm	8mm	57mm



3208-25B

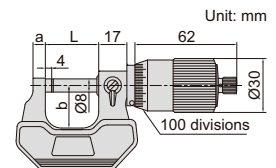

OUTSIDE MICROMETERS



3203-25A

3203-50A



3203-1004A



3203-3006A



- Graduation: metric 0.01mm
inch 0.0001"
- Carbide measuring faces
- Meet DIN863-1
- Supplied with setting standards (except 0-25mm and 0-1")

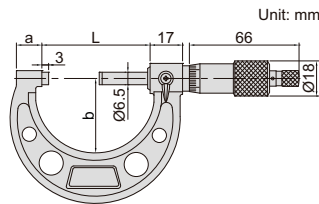

Metric (ratchet stop type)

Code	Range	Accuracy	L	a	b
3203-25A*	0-25mm	±2µm	32mm	9mm	28mm
3203-50A*	25-50mm	±2µm	57mm	14mm	38mm
3203-75A*	50-75mm	±2µm	82mm	15mm	49mm
3203-100A*	75-100mm	±3µm	107mm	15mm	60mm
3203-125A	100-125mm	±3µm	133mm	16.5mm	73mm
3203-150A	125-150mm	±3µm	158mm	16.5mm	85mm
3203-175A	150-175mm	±4µm	183mm	19.4mm	104mm
3203-200A	175-200mm	±4µm	209mm	19.4mm	117mm
3203-225A	200-225mm	±4µm	234mm	19.4mm	130mm
3203-250A	225-250mm	±5µm	260mm	19.4mm	142mm
3203-275A	250-275mm	±5µm	285mm	19.4mm	155mm
3203-300A	275-300mm	±5µm	310mm	19.4mm	168mm

Inch (ratchet stop type)

Code	Range	Accuracy	L	a	b
3203-1A*	0-1"	±.0001"	1.260"	.354"	1.102"
3203-2A*	1-2"	±.0001"	2.244"	.551"	1.496"
3203-3A*	2-3"	±.0001"	3.228"	.591"	1.929"
3203-4A*	3-4"	±.00015"	4.213"	.591"	2.362"
3203-5A*	4-5"	±.00015"	5.236"	.650"	2.874"
3203-6A*	5-6"	±.00015"	6.220"	.650"	3.346"
3203-7A	6-7"	±.0002"	7.205"	.764"	4.094"
3203-8A	7-8"	±.0002"	8.228"	.764"	4.606"
3203-9A	8-9"	±.0002"	9.213"	.764"	5.118"
3203-10A	9-10"	±.00025"	10.236"	.764"	5.591"
3203-11A	10-11"	±.00025"	11.220"	.764"	6.102"
3203-12A	11-12"	±.00025"	12.205"	.764"	6.614"

Metric micrometer set (ratchet stop type)

Code	Range	Micrometers Included	Packaging
3203-753A*	0-75mm	3203-25A, 3203-50A, 3203-75A	blow mould case
3203-1004A*	0-100mm	3203-25A, 3203-50A, 3203-75A, 3203-100A	blow mould case
3203-1506A	0-150mm	3203-25A, 3203-50A, 3203-75A, 3203-100A, 3203-125A, 3203-150A	blow mould case
3203-3006A	150-300mm	3203-175A, 3203-200A, 3203-225A, 3203-250A, 3203-275A, 3203-300A	aluminum box
3203-3012A	0-300mm	3203-25A, 3203-50A, 3203-75A, 3203-100A, 3203-125A, 3203-150A, 3203-175A, 3203-200A, 3203-225A, 3203-250A, 3203-275A, 3203-300A	aluminum box

Inch micrometer set (ratchet stop type)

Code	Range	Micrometers included	Packaging
3203-33A*	0-3"	3203-1A, 3203-2A, 3203-3A	blow mould case
3203-44A*	0-4"	3203-1A, 3203-2A, 3203-3A, 3203-4A	blow mould case
3203-66A*	0-6"	3203-1A, 3203-2A, 3203-3A, 3203-4A, 3203-5A, 3203-6A	blow mould case
3203-126A	6-12"	3203-7A, 3203-8A, 3203-9A, 3203-10A, 3203-11A, 3203-12A	aluminum box
3203-1212A	0-12"	3203-1A, 3203-2A, 3203-3A, 3203-4A, 3203-5A, 3203-6A, 3203-7A, 3203-8A, 3203-9A, 3203-10A, 3203-11A, 3203-12A	aluminum box

Inch (friction thimble type)

Code	Range	Accuracy	L	a	b
3203-1FA*	0-1"	±.0001"	1.260"	.354"	1.102"
3203-2FA*	1-2"	±.0001"	2.244"	.551"	1.496"
3203-3FA*	2-3"	±.0001"	2.244"	.591"	1.929"

*Supplied with manufacturer inspection certificate traceable to DKD Germany or NIST USA

OUTSIDE MICROMETERS

- Graduation 0.01mm
- Carbide measuring faces
- Meet DIN863-1
- Supplied with setting standards (except 0-25mm)



Code	Range	Accuracy	L	a	b
3202-25A*	0-25mm	4µm	32mm	6mm	24mm
3202-50A*	25-50mm	4µm	57mm	8mm	32mm
3202-75A*	50-75mm	5µm	82mm	8mm	45mm
3202-100A*	75-100mm	5µm	107mm	8mm	57mm
3202-125A	100-125mm	6µm	133mm	8mm	70mm
3202-150A	125-150mm	6µm	125mm	8mm	82mm
3202-175A	150-175mm	7µm	183mm	8mm	95mm
3202-200A	175-200mm	7µm	209mm	8mm	107mm

Micrometer set

Code	Range	Micrometers included
3202-753A*	0-75mm	3202-25A, 3202-50A, 3202-75A
3202-1004A*	0-100mm	3202-25A, 3202-50A, 3202-75A, 3202-100A
3202-1506A	0-150mm	3202-25A, 3202-50A, 3202-75A, 3202-100A, 3202-125A, 3202-150A

*Supplied with manufacturer inspection certificate traceable to DKD Germany



3202-25A

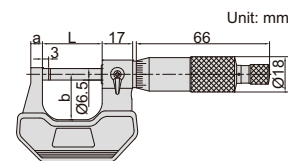

LONG SPINDLE OUTSIDE MICROMETERS

- Graduation 0.01mm
- Carbide measuring faces
- Meet DIN863-1
- Ratchet stop
- Supplied with setting standards (except 0-25mm)

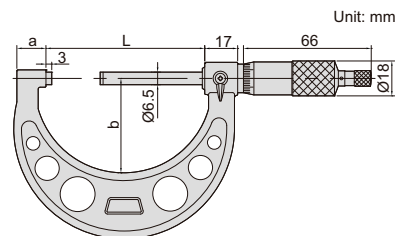

3209-25

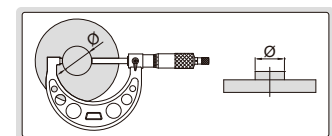
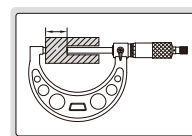

Code	Range	Accuracy	L	a	b
3209-25	0-25mm	4µm	57	14	38
3209-50	25-50mm	4µm	82	15	49
3209-75	50-75mm	5µm	107	15	60
3209-100	75-100mm	5µm	133	16.5	73

OUTSIDE MICROMETERS FOR LEFT OR RIGHT HAND

- Graduation 0.01mm
- Graduations on two sides
- Ratchet stop
- Carbide measuring faces
- Meet DIN863-1
- Supplied with setting standards (except 0-25mm)

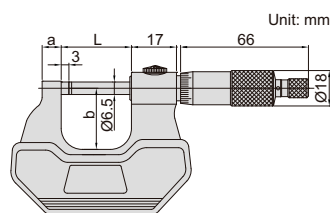

front



back

3236-25B

Code	Range	Accuracy	L	a	b
3236-25B	0-25mm	4µm	32	6	24
3236-50B	25-50mm	4µm	57	8	32



- Graduation 0.001mm
- Carbide measuring faces
- Meet DIN863-1
- Supplied with setting standards (except 0-25mm)

Ratchet stop type (mm)

Code	Range	Accuracy	L	a	b
3210-25A*	0-25mm	4µm	32	9	28
3210-50A*	25-50mm	4µm	57	14	38
3210-75A*	50-75mm	5µm	82	15	49
3210-100A*	75-100mm	5µm	107	15	60
3210-125A	100-125mm	6µm	133	16.5	73
3210-150A	125-150mm	6µm	158	16.5	85
3210-175A	150-175mm	7µm	183	19.4	104
3210-200A	175-200mm	7µm	209	19.4	117

Friction thimble type (mm)

Code	Range	Accuracy	L	a	b
3210-25FA*	0-25mm	4µm	32	9	28
3210-50FA*	25-50mm	4µm	57	14	38

*Supplied with manufacturer inspection certificate traceable to DKD Germany

1µm GRADUATION OUTSIDE MICROMETERS

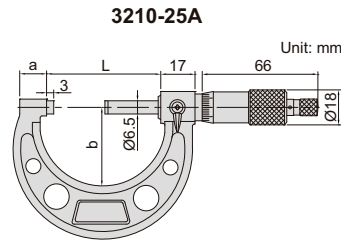

Micrometer set (ratchet stop type)

Code	Range	Micrometers included
3210-753A*	0-75mm	3210-25A, 3210-50A, 3210-75A
3210-1004A*	0-100mm	3210-25A, 3210-50A, 3210-75A, 3210-100A
3210-1506A	0-150mm	3210-25A, 3210-50A, 3210-75A, 3210-100A, 3210-125A, 3210-150A

OUTSIDE MICROMETERS WITH EXTENSION ANVIL COLLAR



adjust collars for different measuring ranges

- Graduation 0.01mm
- Adjust collars for different measuring ranges
- Ratchet stop
- Carbide measuring faces
- Supplied with setting standards



3205-400

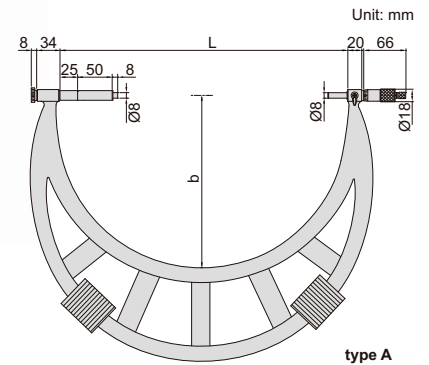

(mm)

Code	Range	Type	Accuracy	L	b	Setting standard (included)
3205-400	300-400mm	A	11µm	410	250	325, 375
3205-500	400-500mm	A	13µm	510	295	425, 475
3205-600	500-600mm	A	14µm	610	345	525, 575
3205-700	600-700mm	A	16µm	710	395	625, 675
3205-800	700-800mm	A	18µm	810	445	725, 775,
3205-900	800-900mm	A	20µm	910	495	825, 875
3205-1000	900-1000mm	A	22µm	1010	545	925, 975
3205-1200	1000-1200mm	B	22µm	1210	645	1050, 1150
3205-1400	1200-1400mm	B	24µm	1410	745	1250, 1350
3205-1600	1400-1600mm	B	28µm	1610	845	1450, 1550
3205-1800	1600-1800mm	B	31µm	1810	945	1650, 1750
3205-2000	1800-2000mm	B	34µm	2010	1045	1850, 1950

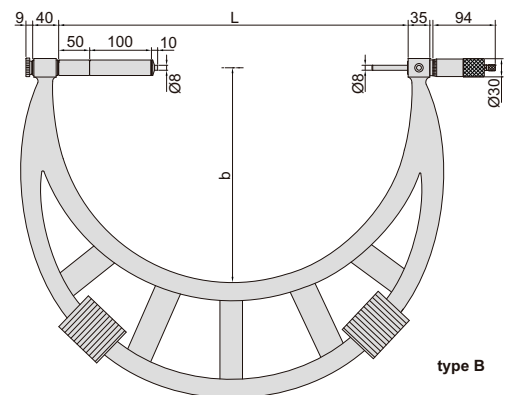

OUTSIDE MICROMETERS WITH INTERCHANGEABLE ANVILS



- Graduation 0.01mm
- Ratchet stop
- Meet DIN863-3
- Carbide measuring faces
- Supplied with setting standard

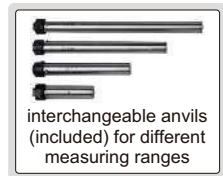

Code	Range	Type	Accuracy	L	b	Setting standard (included)
3206-50A	0-50mm	A	4µm	58	35	25
3206-100A	0-100mm	A	5µm	108	57	25, 50, 75
3206-150A	0-150mm	A	6µm	158	82	25, 50, 75, 100, 125
3206-151A	50-150mm	A	6µm	158	82	50, 75, 100, 125
3206-200A	100-200mm	A	7µm	208	114	100, 125, 150, 175
3206-300A	150-300mm	A	9µm	308	165	150, 175, 200, 225, 250, 275
3206-301A	200-300mm	A	9µm	308	165	200, 225, 250, 275
3206-400	300-400mm	B	11µm	409	224	325, 375
3206-500	400-500mm	B	13µm	509	275	425, 475
3206-600	500-600mm	B	14µm	609	321	525, 575
3206-700	600-700mm	B	16µm	709	371	625, 675
3206-800	700-800mm	B	18µm	809	426	725, 775
3206-900	800-900mm	B	20µm	909	476	825, 875
3206-1000	900-1000mm	B	22µm	1009	576	925, 975

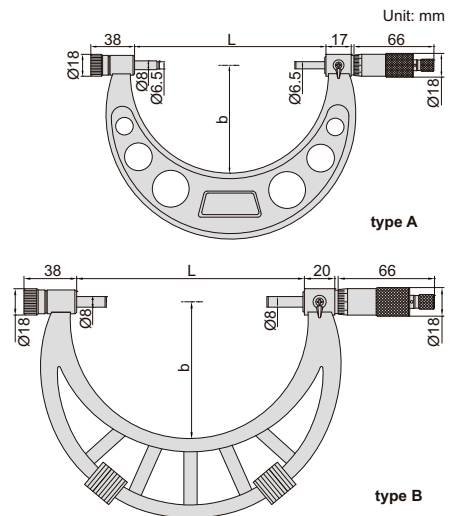

DIGITAL OUTSIDE MICROMETERS WITH INTERCHANGEABLE ANVILS

- Resolution 0.001mm/0.0001" (resolution of 3506-100A and 3506-150A is 0.001mm/0.00005")
- IP65 dust/waterproof
- Button function: on/off, set, mm/inch, ABS/INC
- Data output
- LR44 battery, automatic power off
- Ratchet stop
- Carbide measuring faces
- Supplied with setting standards
- Optional accessory: data output cable (code 7315-, 7302-, 7305-)



3506-100A



3506-400A

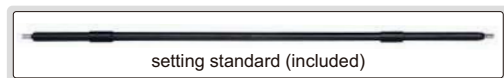
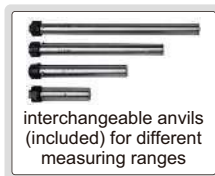

Code	Range	Type	Accuracy	L	b	Setting standard (included)
3506-100A	0-100mm/0-4"	A	±5µm	105	57	25, 50, 75
3506-150A	0-150mm/0-6"	A	±6µm	155	82	25, 50, 75, 100, 125
3506-300A	150-300mm/6-12"	A	±8µm	305	165	150, 175, 200, 225, 250, 275
3506-301A	200-300mm/8-12"	A	±8µm	305	165	200, 225, 250, 275
3506-400A	300-400mm/12-16"	B	±9µm	405	224	325, 375
3506-500A	400-500mm/16-20"	B	±11µm	505	275	425, 475
3506-600A	500-600mm/20-24"	B	±12µm	605	321	525, 575
3506-700A	600-700mm/24-28"	B	±13µm	705	371	625, 675
3506-800A	700-800mm/28-32"	B	±15µm	805	426	725, 775
3506-900A	800-900mm/32-36"	B	±16µm	905	476	825, 875
3506-1000A	900-1000mm/36-40"	B	±17µm	1005	576	925, 975

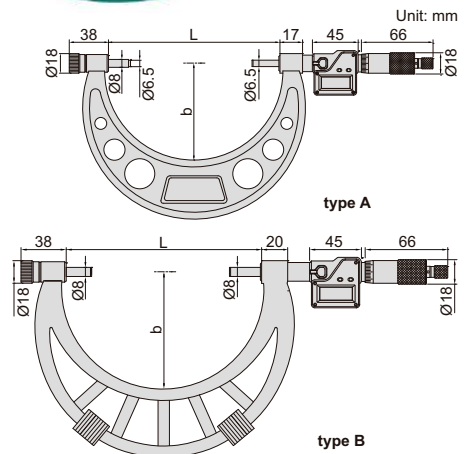

INDICATING MICROMETERS

ATTENTION: SETTING STANDARDS ARE NOT INCLUDED

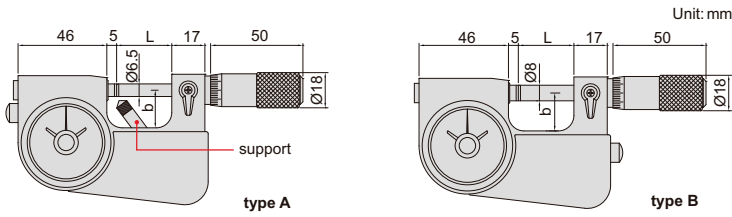

- Meet DIN863-3
- Micrometer head graduation: 0.002mm
- Dial indicator: range ± 0.04 mm, graduation 0.001mm, accuracy 0.001mm
- Carbide measuring faces
- Optional accessory: gage blocks grade 0 (4101-A series), for zero setting

Code	Micrometer head range	Micrometer head accuracy	Type	L	b	Remark
3332-25	0-25mm	4 μ m	A	28.5	19	with support
3332-50	25-50mm	4 μ m	A	53.5	30	with support
3332-75	50-75mm	5 μ m	A	78.5	45	without support
3332-100	75-100mm	5 μ m	A	103.5	57	without support
3332-25B	0-25mm	4 μ m	B	28.5	19	without support



3332-25



3332-25B

5

LIMIT MICROMETERS

- Used as Go/No-Go gauge by setting upper and lower limits
- Graduation 0.002mm
- Carbide measuring faces
- Supplied with setting standard (except 0-25mm)

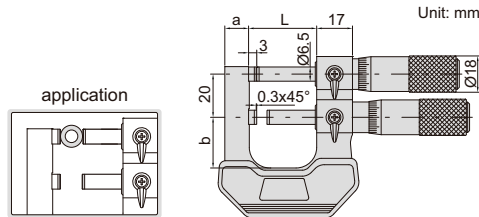

Code	Range	Accuracy	L	a	b
3235-25A	0-25mm	4 μ m	32mm	12mm	24mm
3235-50A	25-50mm	4 μ m	57mm	15mm	32mm



3235-25A

ATTENTION: NOT SUITABLE FOR 0.001MM INDICATORS

MICROMETERS WITH DIAL INDICATING

- Meet DIN863-3
- Micrometer head graduation 0.01mm
- Anvil retracting range: 8mm
- Carbide measuring faces
- Supplied with setting standards (except 0-25mm)
- Optional accessory: dial indicators (graduation 0.01mm), digital indicators (resolution 0.01mm/0.0005")



3331-25A

Code	Micrometer head range	Micrometer head accuracy	L	b
3331-25A	0-25mm	4 μ m	67mm	38mm
3331-50A	25-50mm	4 μ m	92.4mm	50mm
3331-75A	50-75mm	5 μ m	117.6mm	62mm
3331-100A	75-100mm	5 μ m	143mm	70mm
3331-125A	100-125mm	6 μ m	168.2mm	82mm
3331-150A	125-150mm	6 μ m	192mm	94.5mm
3331-175A	150-175mm	7 μ m	217mm	107mm

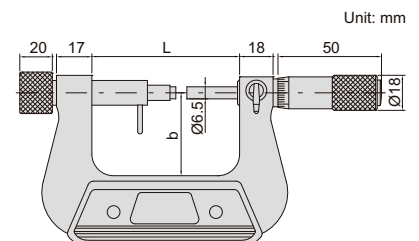

MICROMETERS WITH DIAL INDICATOR

ATTENTION: NOT SUITABLE FOR 0.001MM INDICATORS



dial indicator is optional

3296-100A

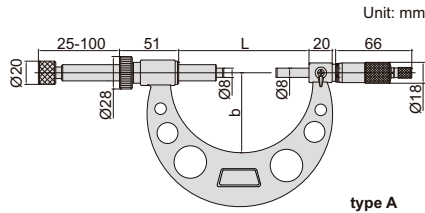

type A

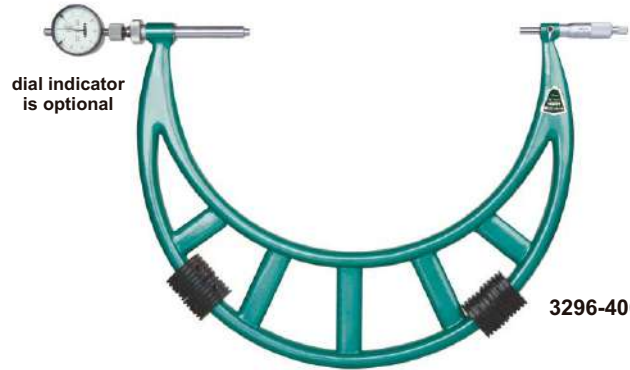

dial indicator is optional

3296-400A

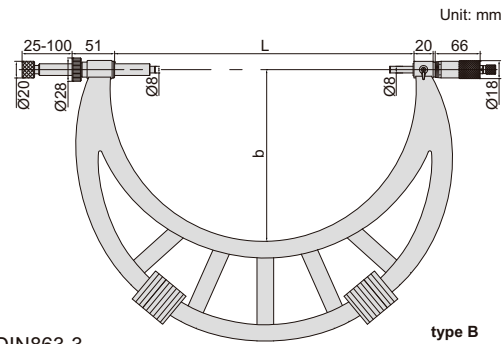

type B

Code	Range	Type	Accuracy	L	b
3296-100A	0-100mm	A	6µm	115	68
3296-200A	100-200mm	A	7µm	215	120
3296-300A	200-300mm	A	8µm	315	170
3296-400A	300-400mm	B	9µm	415	225
3296-500A	400-500mm	B	10µm	515	275
3296-600A	500-600mm	B	11µm	615	325
3296-700A	600-700mm	B	12µm	715	375
3296-800A	700-800mm	B	13µm	815	430
3296-900A	800-900mm	B	14µm	915	480
3296-1000A	900-1000mm	B	15µm	1015	530

- Meet DIN863-3
- Graduation 0.01mm
- Ratchet stop
- Carbide measuring faces
- Supplied with setting standards
- Optional accessory: dial indicators (graduation 0.01mm) digital indicators (resolution 0.01mm/0.0005")

GROOVE MICROMETERS

- Measure width of grooves inside bores
- Graduation 0.01mm
- Two graduations for inside and outside measurement
- Non-rotating spindle



3287-25A



3287-25B

No ratchet stop

Code	Range (outside A)	Range (inside B)	Accuracy
3287-25A	0-25mm	1.6-26.5mm	10µm
3287-50A	25-50mm	26.5-51.5mm	10µm
3287-75A	50-75mm	51.5-76.5mm	10µm
3287-100A	75-100mm	76.5-101.5mm	10µm

Two-directional ratchet stop

Code	Range (outside A)	Range (inside B)	Accuracy
3287-25B	0-25mm	1.6-26.5mm	10µm
3287-50B	25-50mm	26.5-51.5mm	10µm
3287-75B	50-75mm	51.5-76.5mm	10µm
3287-100B	75-100mm	76.5-101.5mm	10µm

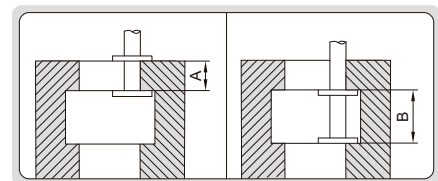
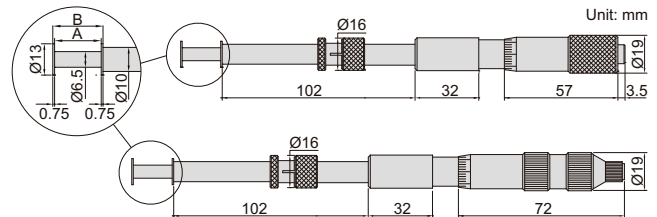



- Used with standard outside micrometers to measure pitch diameter of screw threads
- Diameter accuracy: $\pm 0.5\mu\text{m}$
- Cylindricity: $1\mu\text{m}$
- Hardness: HRC60
- Supplied with manufacturer inspection certificate

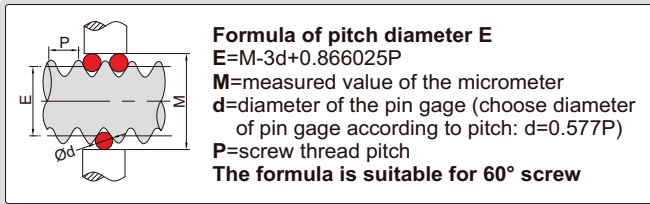

7382-19

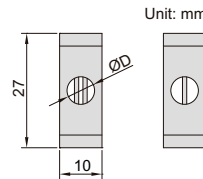

application



For outside micrometers with spindle Ø6.35mm (ØD)

Code	Pin gage diameter (Ød)	Applicable pitch
7382-11	0.170mm	0.2mm, 0.25mm, 0.3mm
7382-12	0.195mm	0.35mm
7382-13	0.220mm	0.4mm
7382-14	0.250mm	0.45mm
7382-15	0.290mm	0.5mm
7382-16	0.335mm	0.6mm
7382-17	0.390mm	0.7mm
7382-18	0.455mm	0.75mm, 0.8mm
7382-19	0.530mm	0.9mm
7382-110	0.620mm	1.0mm
7382-111	0.725mm	1.25mm
7382-112	0.895mm	1.5mm
7382-113	1.100mm	1.75mm, 2.0mm
7382-114	1.350mm	2.5mm
7382-115	1.650mm	3.0mm
7382-116	2.050mm	3.5mm
7382-117	2.550mm	4mm, 4.5mm
7382-118	3.200mm	5mm, 5.5mm, 6mm
7382-1S	18 pairs/set, including all above 3-wires	

For outside micrometers with spindle Ø6.50mm (ØD)

Code	Pin gage diameter (Ød)	Applicable pitch
7382-21	0.170mm	0.2mm, 0.25mm, 0.3mm
7382-22	0.195mm	0.35mm
7382-23	0.220mm	0.4mm
7382-24	0.250mm	0.45mm
7382-25	0.290mm	0.5mm
7382-26	0.335mm	0.6mm
7382-27	0.390mm	0.7mm
7382-28	0.455mm	0.75mm, 0.8mm
7382-29	0.530mm	0.9mm
7382-210	0.620mm	1.0mm
7382-211	0.725mm	1.25mm
7382-212	0.895mm	1.5mm
7382-213	1.100mm	1.75mm, 2.0mm
7382-214	1.350mm	2.5mm
7382-215	1.650mm	3.0mm
7382-216	2.050mm	3.5mm
7382-217	2.550mm	4mm, 4.5mm
7382-218	3.200mm	5mm, 5.5mm, 6mm
7382-2S	18 pairs/set, including all above 3-wires	

MEASURING TIPS FOR SCREW THREAD MICROMETERS

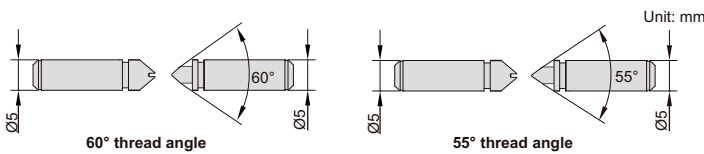

7381-T13

Whitworth thread (55° thread angle)

Metric and unified thread (60° thread angle)

Code	Pitch
7381-T11	0.4-0.5mm/ 64-48TPI
7381-T12	0.6-0.9mm/ 44-28TPI
7381-T13	1-1.75mm/ 24-14TPI
7381-T14	2-3mm/ 13-9TPI
7381-T15	3.5-5mm/ 8-5TPI
7381-T16	5.5-7mm/ 4.5-3.5TPI
7381-TS	6 pairs/set, including all above tips

- Supplied in pair
- Suitable for 3281, 3581 series micrometers

Code	Pitch
7381-T21	60-48TPI
7381-T22	48-40TPI
7381-T23	40-32TPI
7381-T24	32-24TPI
7381-T25	24-18TPI
7381-T26	18-14TPI
7381-T27	14-10TPI
7381-T28	10-7TPI
7381-T29	7-4.5TPI
7381-T210	4.5-3.5TPI
7381-T2S	10 pairs/set, including all above tips

SCREW THREAD MICROMETERS

- Measure pitch diameter of screw threads
- Graduation 0.01mm
- Non-rotating spindle
- Ratchet stop
- Supplied with 60° setting standards
- Optional accessory: 55° setting standards, measuring tips (code 7381)

measuring tips are optional

NON-ROTATING SPINDLE



3281-25A

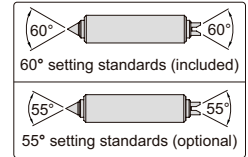

5

Code	Range	L	b	55° setting standard (optional)
3281-25A	0-25mm	42	26	-
3281-50A	25-50mm	67	38	3281-SP1
3281-75A	50-75mm	92	50	3281-SP2
3281-100A	75-100mm	117.6	62	3281-SP3
3281-125A	100-125mm	143	70	3281-SP4
3281-150A	125-150mm	168.2	82	3281-SP5
3281-175A	150-175mm	192	94.5	3281-SP6
3281-200A	175-200mm	217	107	3281-SP7

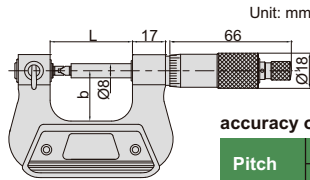

accuracy of micrometers with tips

(mm)

Pitch	Range					
	0-25	25-50	50-75	75-100	100-125	125-200
0.4~0.5	±0.01	-	-	-	-	-
0.6~0.8	±0.01	±0.013	-	-	-	-
1~1.25	±0.012	±0.015	±0.017	±0.017	-	-
1.5~2.0	±0.014	±0.017	±0.019	±0.019	±0.020	±0.023
2.5~3.5	±0.016	±0.019	±0.021	±0.021	±0.023	±0.025
4.0~7.0	-	±0.021	±0.023	±0.023	±0.025	±0.028

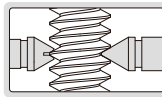

DIGITAL SCREW THREAD MICROMETERS

- Measure pitch diameter of screw threads
- Resolution 0.001mm/0.00005"
- Button function: on/off, set, mm/inch, ABS/INC
- Data output
- LR44 battery, automatic power off
- Non-rotating spindle
- Ratchet stop
- Supplied with 60° setting standards
- Optional accessory: 55° setting standards, measuring tips (code 7381), data output cable (code 7315-, 7302-, 7305-)

measuring tips are optional

DATA OUTPUT

NON-ROTATING SPINDLE



3581-25A

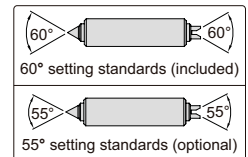

accuracy of micrometers with tips (mm)

Pitch	Range			
	0-25	25-50	50-75	75-100
0.4~0.5	±0.01	-	-	-
0.6~0.8	±0.01	±0.013	-	-
1~1.25	±0.012	±0.015	±0.017	±0.017
1.5~2.0	±0.014	±0.017	±0.019	±0.019
2.5~3.5	±0.016	±0.019	±0.021	±0.021
4.0~7.0	-	±0.021	±0.023	±0.023

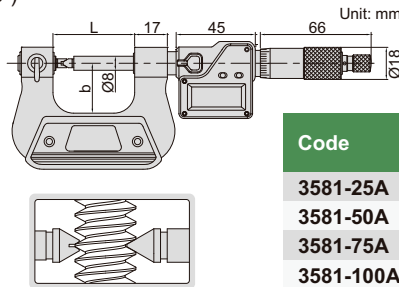

Code	Range	L	b	55° setting standard (optional)
3581-25A	0-25mm/0-1"	42	26	-
3581-50A	25-50mm/1-2"	67	38	3281-SP1
3581-75A	50-75mm/2-3"	92	50	3281-SP2
3581-100A	75-100mm/3-4"	117.6	62	3281-SP3

GEAR TOOTH MICROMETERS

- Meet DIN863-3
- Measure over-pin diameter of gears
- Graduation 0.01mm
- Ratchet stop
- Supplied with setting standards (except 0-25mm)
- Optional accessory: ball tips (code 7391)

ball tips are optional



3291-25

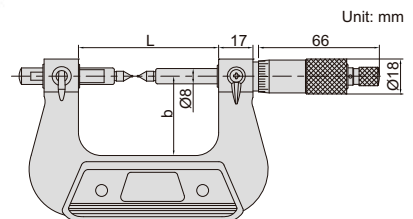

Code	Range	Accuracy	L	b
3291-25	0-25mm	4μm	67	38
3291-50	25-50mm	4μm	92.4	50
3291-75	50-75mm	5μm	117.6	62
3291-100	75-100mm	5μm	143	70
3291-125	100-125mm	6μm	168.2	82
3291-150	125-150mm	6μm	192	94.5
3291-175	150-175mm	7μm	217	107

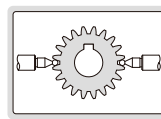

IP65
WATERPROOF

DATA
OUTPUT

DIGITAL GEAR TOOTH MICROMETERS

- Measure over-pin diameter of gears
- Resolution 0.001mm/0.00005"
- IP65 dust/waterproof
- Button function: on/off, set, mm/inch, ABS/INC
- Data output
- LR44 battery, automatic power off
- Ratchet stop
- Supplied with setting standards (except 0-25mm/0-1")
- Optional accessory: ball tips (code 7391), data output cable (code 7315-, 7302-, 7305-)

ball tips are optional



3591-25A

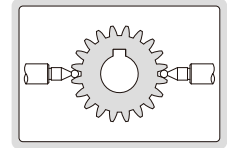

5

Code	Range	Accuracy	L	b
3591-25A	0-25mm/0-1"	±4μm	67	38
3591-50A	25-50mm/1-2"	±4μm	92.4	50
3591-75A	50-75mm/2-3"	±5μm	117.6	62
3591-100A	75-100mm/3-4"	±5μm	143	70

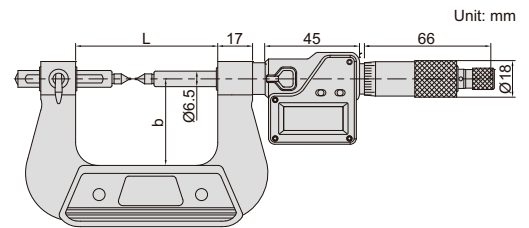

BALL TIPS FOR GEAR TOOTH MICROMETERS

- Supplied in pair
- Suitable for 3291, 3591 series micrometers



7391-T5

Code	Ball dia. (D)	Code	Ball dia. (D)
7391-T2	SØ1.5mm	7391-T7	SØ4.0mm
7391-T3	SØ2.0mm	7391-T8	SØ4.5mm
7391-T4	SØ2.5mm	7391-T9	SØ5.0mm
7391-T5	SØ3.0mm	7391-T10	SØ6.0mm
7391-T6	SØ3.5mm		



POINT MICROMETERS

- Measure the web thickness of drills, small grooves and keyways
- Graduation 0.01mm
- Ratchet stop
- Carbide tips
- Supplied with setting standards (except 0-25mm)



3230-25A

Code	Range	Type	Accuracy	L	b
3230-25A	0-25mm	A	4μm	57	32
3230-50A	25-50mm	A	4μm	82	44.5
3230-75A	50-75mm	A	5μm	107	57
3230-100A	75-100mm	A	5μm	132.6	69.5
3230-25BA	0-25mm	B	4μm	57	32
3230-50BA	25-50mm	B	4μm	82	44.5
3230-75BA	50-75mm	B	5μm	107	57
3230-100BA	75-100mm	B	5μm	132.6	69.5

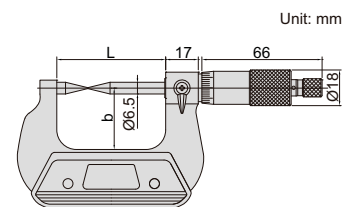
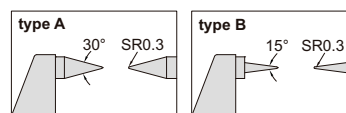

DIGITAL POINT MICROMETERS

- Measure the web thickness of drills, small grooves and keyways
- Resolution 0.001mm/0.00005"
- IP65 dust/waterproof
- Button function: on/off, set, mm/inch, ABS/INC
- Data output
- LR44 battery, automatic power off
- Ratchet stop
- Carbide tips
- Supplied with setting standards (except 0-25mm/0-1")
- Optional accessory: data output cable (code 7315-, 7302-, 7305-)

DATA OUTPUT

IP65 WATERPROOF



3530-25A

Code	Range	Type	Accuracy	L	b
3530-25A	0-25mm/0-1"	A	±4μm	57	32
3530-50A	25-50mm/1-2"	A	±4μm	82	44.5
3530-75A	50-75mm/2-3"	A	±5μm	107	57
3530-100A	75-100mm/3-4"	A	±5μm	132.6	69.5
3530-25BA	0-25mm/0-1"	B	±4μm	57	32
3530-50BA	25-50mm/1-2"	B	±4μm	82	44.5
3530-75BA	50-75mm/2-3"	B	±5μm	107	57
3530-100BA	75-100mm/3-4"	B	±5μm	132.6	69.5

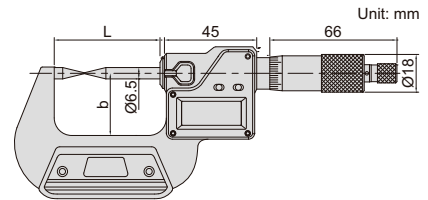
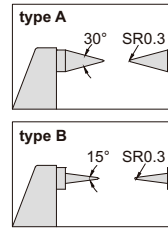

BLADE MICROMETERS

- Meet DIN863-3
- Measure the groove diameter of shafts and keyways
- Graduation 0.01mm
- Non-rotating spindle
- Ratchet stop
- Supplied with setting standards (except 0-25mm)

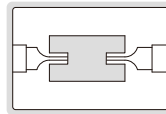

NON-ROTATING SPINDLE



3232-25A

Code	Range	Type	Accuracy	L	b
3232-25A	0-25mm	A	4μm	57	32
3232-50A	25-50mm	A	4μm	82	44.5
3232-75A	50-75mm	A	5μm	107	57
3232-100A	75-100mm	A	5μm	132.6	69.5
3232-125A	100-125mm	A	6μm	158	82
3232-150A	125-150mm	A	6μm	183.4	94.5
3232-175A	150-175mm	A	7μm	208.8	107
3232-25BA	0-25mm	B	4μm	57	32
3232-50BA	25-50mm	B	4μm	82	44.5

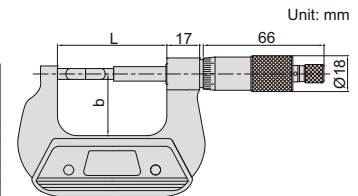
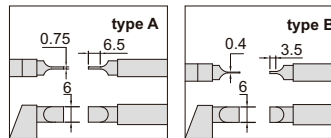

DIGITAL BLADE MICROMETERS

- Measure the groove diameter of shafts and keyways
- Resolution 0.001mm/0.00005"
- Non-rotating spindle
- Button function: on/off, set, mm/inch, ABS/INC
- Data output
- LR44 battery, automatic power off
- Ratchet stop
- Supplied with setting standards (except 0-25mm/0-1")
- Optional accessory: data output cable (code 7315-, 7302-, 7305-)

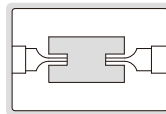

DATA OUTPUT

NON-ROTATING SPINDLE



3532-25A

Code	Range	Type	Accuracy	L	b
3532-25A	0-25mm/0-1"	A	±4μm	57	32
3532-50A	25-50mm/1-2"	A	±4μm	82	44.5
3532-75A	50-75mm/2-3"	A	±5μm	107	57
3532-100A	75-100mm/3-4"	A	±5μm	132.6	69.5
3532-25BA	0-25mm/0-1"	B	±4μm	57	32
3532-50BA	25-50mm/1-2"	B	±4μm	82	44.5

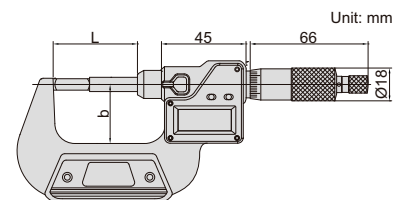
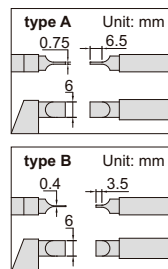

RELATIVE PRODUCT: DIGITAL CRIMP HEIGHT CALIPER (CODE 1165-150A)

CRIMP HEIGHT MICROMETER

- Measure the height of crimp contact
- Graduation 0.01mm
- Ratchet stop



3266-25BA

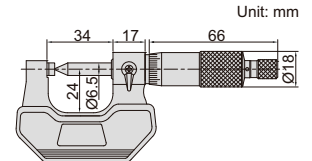
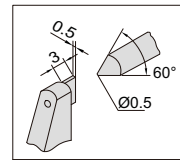
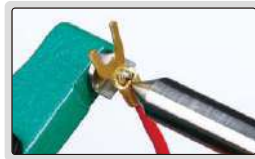

Unit: mm

Code	Range	Accuracy
3266-25BA	0-25mm	4μm

5

IP65
WATERPROOF

DATA
OUTPUT

RELATIVE PRODUCT: DIGITAL CRIMP HEIGHT CALIPER (CODE 1165-150A)

DIGITAL CRIMP HEIGHT MICROMETER

- Measure the height of crimp contact
- Resolution 0.001mm/0.00005"
- IP65 dust/waterproof
- Button function: on/off, set, mm/inch, ABS/INC
- Data output
- LR44 battery, automatic power off
- Ratchet stop
- Optional accessory: data output cable (code 7315-, 7302-, 7305-)



3566-25BA

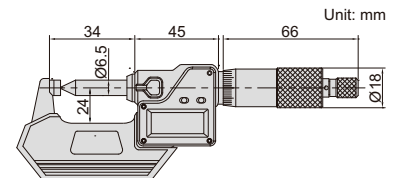
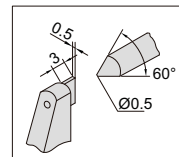
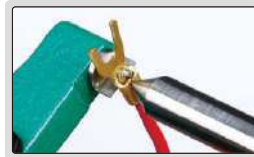

Unit: mm

Code	Range	Accuracy
3566-25BA	0-25mm/0-1"	±4μm

SPLINE MICROMETERS

- Meet DIN863-3
- Measure splined shafts, slots and keyways
- Graduation 0.01mm
- Ratchet stop
- Carbide measuring faces
- Supplied with setting standards (except 0-25mm)

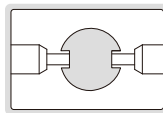

3233-25BA

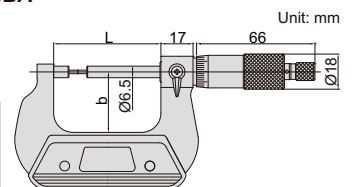
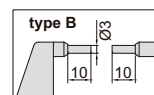
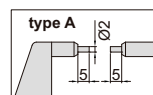

Unit: mm

Code	Range	Type	Accuracy	L	b
3233-25A	0-25mm	A	4μm	57	32
3233-25BA	0-25mm	B	4μm	57	32
3233-50BA	25-50mm	B	4μm	82	44.5
3233-75BA	50-75mm	B	5μm	107	57
3233-100BA	75-100mm	B	5μm	132.6	69.5
3233-125BA	100-125mm	B	6μm	158	82
3233-150BA	125-150mm	B	6μm	183.4	94.5
3233-175BA	150-175mm	B	7μm	208.8	107

(mm)

DIGITAL SPLINE MICROMETERS

IP65
WATERPROOF

DATA
OUTPUT

- Measure splined shafts, slots and keyways
- Resolution 0.001mm/0.00005"
- IP65 dust/waterproof
- Button function: on/off, set, mm/inch, ABS/INC
- Data output
- LR44 battery, automatic power off
- Ratchet stop
- Carbide measuring faces
- Supplied with setting standards (except 0-25mm/0-1")
- Optional accessory: data output cable (code 7315-, 7302-, 7305-)



3533-25BA

Code	Range	Type	Accuracy	L	b
3533-25A	0-25mm/0-1"	A	±4μm	57	32
3533-50A	25-50mm/1-2"	A	±4μm	82	44.5
3533-75A	50-75mm/2-3"	A	±5μm	107	57
3533-100A	75-100mm/3-4"	A	±5μm	132.6	69.5
3533-25BA	0-25mm/0-1"	B	±4μm	57	32
3533-50BA	25-50mm/1-2"	B	±4μm	82	44.5
3533-75BA	50-75mm/2-3"	B	±5μm	107	57
3533-100BA	75-100mm/3-4"	B	±5μm	132.6	69.5

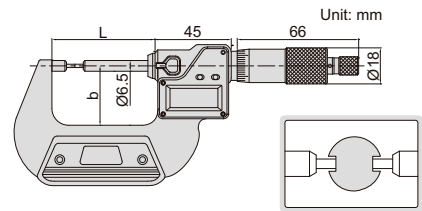
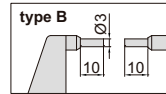
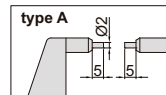

CYLINDRICAL ANVIL TUBE MICROMETERS

- Measure wall thickness of tubes
- Graduation 0.01mm
- Ratchet stop
- Carbide spindle tip
- Supplied with setting standards (except 0-25mm)



3261-25A

Code	Range	Type	Accuracy	L	b
3261-25A	0-25mm	A	6μm	31	24
3261-50A	25-50mm	A	6μm	57	32
3261-25BA	0-25mm	B	6μm	31	24
3261-50BA	25-50mm	B	6μm	57	32
3261-25CA	0-25mm	C	6μm	31	24
3261-25DA	0-25mm	D	6μm	31	24

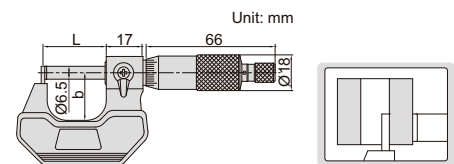
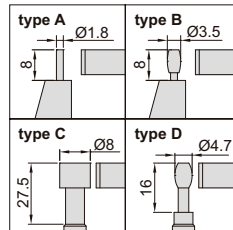

DIGITAL CYLINDRICAL ANVIL TUBE MICROMETERS

IP65
WATERPROOF

DATA
OUTPUT

- Measure wall thickness of tubes
- Resolution 0.001mm/0.00005"
- IP65 dust/waterproof
- Button function: on/off, set, mm/inch, ABS/INC
- Data output
- LR44 battery, automatic power off
- Ratchet stop
- Carbide spindle tip
- Supplied with setting standards (except 0-25mm/0-1")
- Optional accessory: data output cable (code 7315-, 7302-, 7305-)



3561-25A

Code	Range	Type	Accuracy
3561-25A	0-25mm/0-1"	A	±6μm
3561-25BA	0-25mm/0-1"	B	±6μm
3561-25CA	0-25mm/0-1"	C	±6μm
3561-25DA	0-25mm/0-1"	D	±6μm

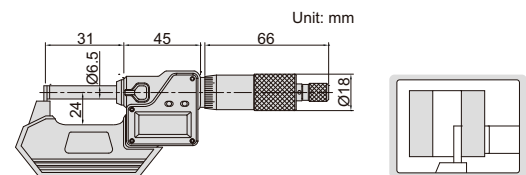
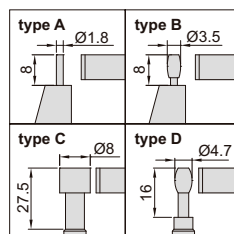

SPHERICAL ANVIL TUBE MICROMETERS

- Meet DIN863-3
- Measure wall thickness of tubes
- Graduation 0.01mm
- Ratchet stop
- Carbide measuring faces
- Supplied with setting standards (except 0-25mm)

Code	Range	Type	Accuracy	L	b
3260-25A	0-25mm	A	4µm	32	24
3260-50A	25-50mm	A	4µm	57	32
3260-75A	50-75mm	A	5µm	82	44.5
3260-100A	75-100mm	A	5µm	107	57
3260-25SA	0-25mm	B	4µm	32	24
3260-50SA	25-50mm	B	4µm	57	32
3260-75SA	50-75mm	B	5µm	82	44.5
3260-100SA	75-100mm	B	5µm	107	57

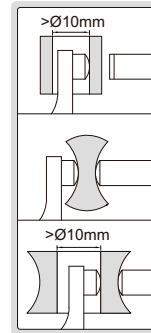

3260-25A

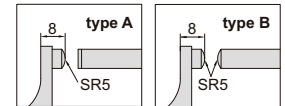
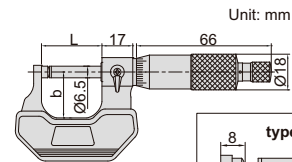

IP65
WATERPROOF

DATA
OUTPUT

DIGITAL SPHERICAL ANVIL TUBE MICROMETERS

- Measure wall thickness of tubes
- Resolution 0.001mm/0.00005"
- IP65 dust/waterproof
- Button function: on/off, set, mm/inch, ABS/INC, data output
- Data output
- LR44 battery, automatic power off
- Ratchet stop
- Carbide measuring faces
- Supplied with setting standards (except 0-25mm/0-1")
- Optional accessory: data output cable (code 7315-, 7302-, 7305-)

Code	Range	Type	Accuracy	L	b
3560-25A	0-25mm/0-1"	A	±4µm	32	24
3560-50A	25-50mm/1-2"	A	±4µm	57	32
3560-75A	50-75mm/2-3"	A	±5µm	82	44.5
3560-100A	75-100mm/3-4"	A	±5µm	107	57
3560-25SA	0-25mm/0-1"	B	±4µm	32	24
3560-50SA	25-50mm/1-2"	B	±4µm	57	32
3560-75SA	50-75mm/2-3"	B	±5µm	82	44.5
3560-100SA	75-100mm/3-4"	B	±5µm	107	57

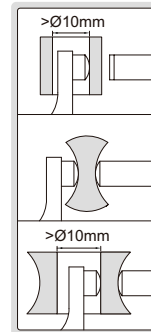

3560-25A

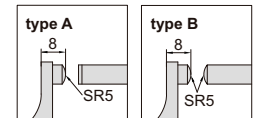
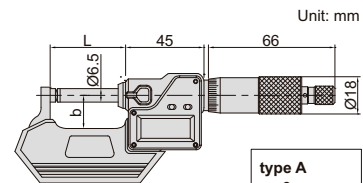

RELATIVE PRODUCT: DIGITAL DISK BRAKE AND PAD CALIPER
DIGITAL DRUM BRAKE CALIPER (CODE 1162-125A, 1167-150A, 1168-300A)

- Measure thickness of disk brakes
- Graduation 0.01mm
- Ratchet stop
- Carbide measuring faces
- Supplied with setting standards

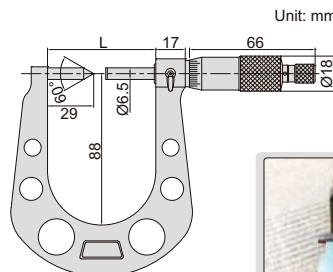

Code	Range	Accuracy	L
3288-33A	7.6-33mm	5µm	64.5mm
3288-50A	25-50mm	5µm	82mm

DISK BRAKE MICROMETERS



3288-33A

DIGITAL DISK BRAKE MICROMETERS

RELATIVE PRODUCT: DIGITAL DISK BRAKE AND PAD CALIPER
DIGITAL DRUM BRAKE CALIPER (CODE 1162-125A, 1167-150A, 1168-300A)

IP65
WATERPROOF

DATA
OUTPUT

- Measure thickness of disk brakes
- Resolution 0.001mm/0.00005"
- IP65 dust/waterproof
- Button function: on/off, set, mm/inch, ABS/INC
- Data output
- LR44 battery, automatic power off
- Ratchet stop
- Carbide measuring faces
- Supplied with setting standards
- Optional accessory: data output cable (code 7315-, 7302-, 7305-)

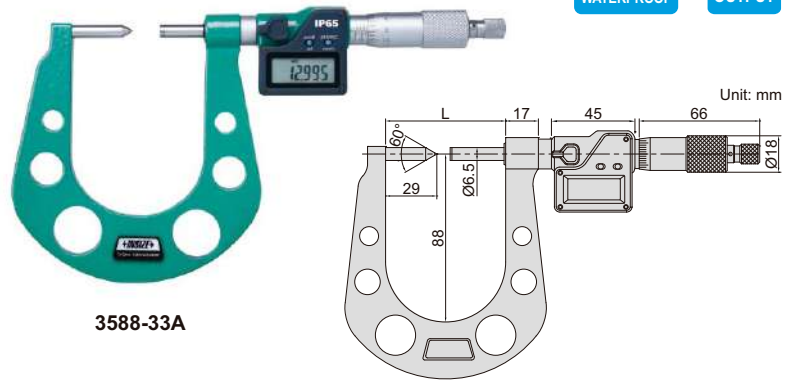

3588-33A

(mm)

Code	Range	Accuracy	L
3588-33A	7.6-33mm/0.3-1.3"	±5µm	64.5
3588-50A	25-50mm/1-2"	±5µm	82

5

SHEET METAL MICROMETERS

- Deep frame suitable for sheet metal, paper and plastic
- Graduation 0.01mm
- Ratchet stop
- Carbide measuring faces

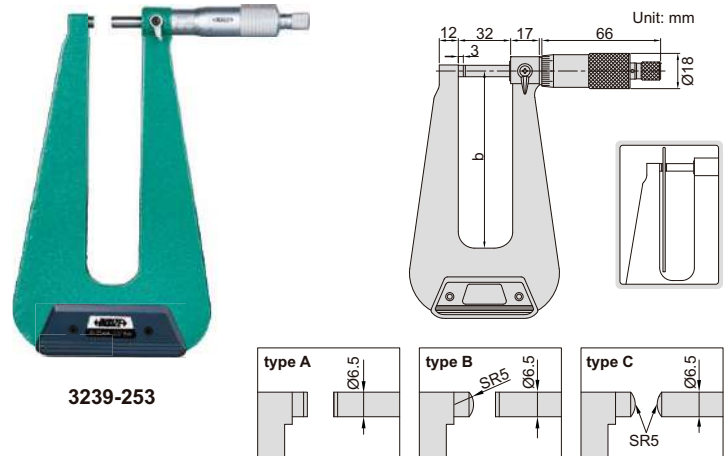

3239-253

(mm)

Code	Range	Type	Accuracy	b
3239-253	0-25mm	A	7µm	155
3239-253F	0-25mm	B	7µm	155
3239-254F	0-25mm	B	10µm	310
3239-253S	0-25mm	C	7µm	155

DIGITAL SHEET METAL MICROMETERS

DATA
OUTPUT

IP65
WATERPROOF

- Deep frame suitable for sheet metal, paper and plastic
- Resolution 0.001mm/0.00005"
- IP65 dust/waterproof
- Button function: on/off, set, mm/inch, ABS/INC
- Data output
- LR44 battery, automatic power off
- Ratchet stop
- Carbide measuring faces
- Optional accessory: data output cable (code 7315-, 7302-, 7305-)

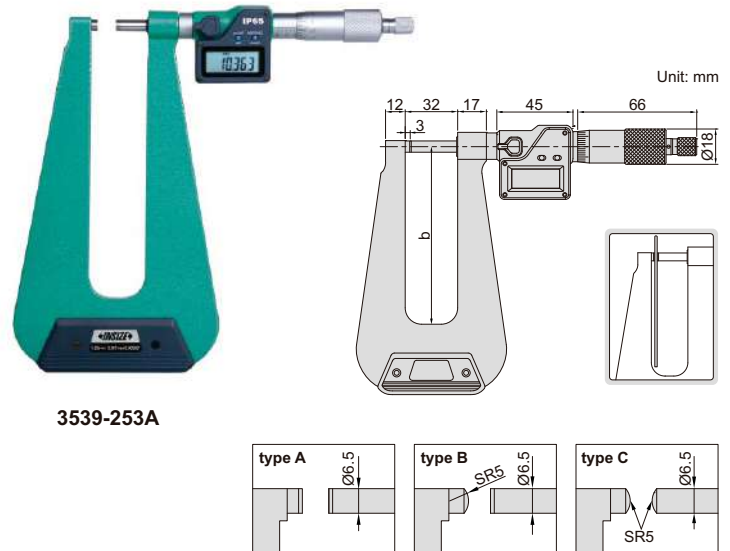

3539-253A

(mm)

Code	Range	Type	Accuracy	b
3539-253A	0-25mm/0-1"	A	±7µm	155
3539-253FA	0-25mm/0-1"	B	±7µm	155
3539-254FA	0-25mm/0-1"	B	±10µm	310
3539-253SA	0-25mm/0-1"	C	±7µm	155

INTERCHANGEABLE ANVIL MICROMETERS

- Measure tube thickness, shoulder edge distance, rivet head height, etc.
- Supplied with flat anvil and rod anvil
- Graduation 0.01mm
- Ratchet stop
- Carbide spindle tip
- Setting standards are included (except 0-25mm)

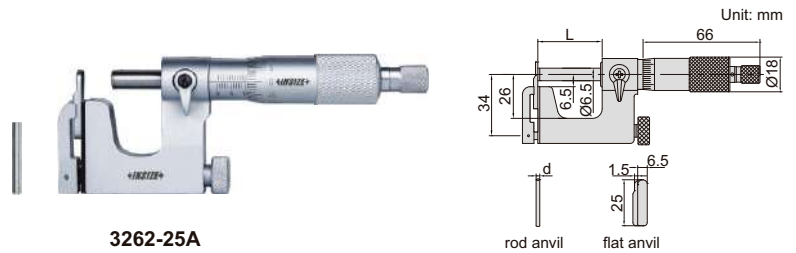

3262-25A

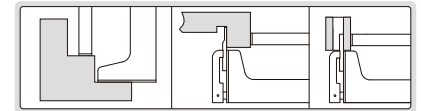

(mm)				
Code	Range	Accuracy	L	d
3262-25A	0-25mm	4µm	28.5	Ø3
3262-50A	25-50mm	4µm	53.5	Ø5

IP65
WATERPROOF

DATA
OUTPUT

DIGITAL INTERCHANGEABLE ANVIL MICROMETERS

- Measure tube thickness, shoulder edge distance, rivet head height, etc.
- Supplied with flat anvil and rod anvil
- Resolution 0.001mm/0.00005"
- IP65 dust/waterproof
- Button function: on/off, set, mm/inch, ABS/INC
- Data output
- LR44 battery, automatic power off
- Ratchet stop
- Carbide spindle tip
- Setting standards are included (except 0-25mm/0-1")
- Optional accessory: data output cable (code 7315-, 7302-, 7305-)



3562-25A

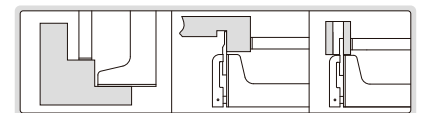
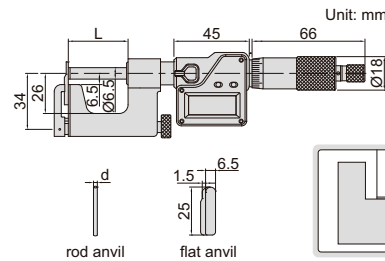

(mm)				
Code	Range	Accuracy	L	d
3562-25A	0-25mm/0-1"	±4µm	28.5	Ø3
3562-50A	25-50mm/1-2"	±4µm	53.5	Ø5

V-ANVIL MICROMETERS

- Measure the diameter of parts or cutting tools with odd grooves, such as taps, reamers and end mills
- Graduation 0.01mm
- Ratchet stop
- Carbide measuring faces
- Supplied with setting standards



3290-153A

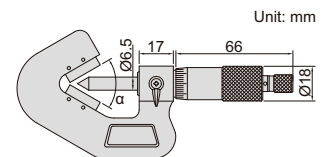

Code	Range	Flutes	Accuracy	α
3290-153A	1-15mm	3	4µm	60°
3290-203A	5-20mm	3	4µm	60°
3290-353A	20-35mm	3	5µm	60°
3290-503A	35-50mm	3	5µm	60°
3290-653A	50-65mm	3	6µm	60°
3290-803A	65-80mm	3	6µm	60°
3290-953A	80-95mm	3	7µm	60°
3290-255A	5-25mm	5	4µm	108°

Code	Range	Flutes	Accuracy	α
3290-455A	25-45mm	5	5µm	108°
3290-655A	45-65mm	5	6µm	108°
3290-855A	65-85mm	5	7µm	108°
3290-1055A	85-105mm	5	8µm	108°
3290-257A	5-25mm	7	4µm	128°34'17"
3290-457A	25-45mm	7	5µm	128°34'17"
3290-657A	45-65mm	7	6µm	128°34'17"
3290-857A	65-85mm	7	7µm	128°34'17"

DIGITAL V-ANVIL MICROMETERS

IP65
WATERPROOF

DATA
OUTPUT

5

- Measure the diameter of parts or cutting tools with odd grooves, such as taps, reamers and end mills
- Resolution 0.001mm/0.00005"
- IP65 dust/waterproof
- Button function: on/off, set, mm/inch, ABS/INC
- Data output
- LR44 battery, automatic power off
- Ratchet stop
- Carbide measuring faces
- Supplied with setting standards
- Optional accessory: data output cable (code 7315-, 7302-, 7305-)



3590-153A

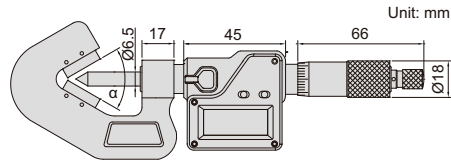

Code	Range	Flutes	Accuracy	α
3590-153A	1-15mm/0.04-0.6"	3	$\pm 4\mu\text{m}$	60°
3590-203A	5-20mm/0.2-0.8"	3	$\pm 4\mu\text{m}$	60°
3590-353A	20-35mm/0.8-1.4"	3	$\pm 5\mu\text{m}$	60°
3590-503A	35-50mm/1.4-2.0"	3	$\pm 5\mu\text{m}$	60°
3590-653A	50-65mm/2.0-2.6"	3	$\pm 6\mu\text{m}$	60°
3590-803A	65-80mm/2.6-3.2"	3	$\pm 6\mu\text{m}$	60°
3590-953A	80-95mm/3.2-3.6"	3	$\pm 6\mu\text{m}$	60°
3590-255A	5-25mm/0.2-1.0"	5	$\pm 4\mu\text{m}$	108°

Code	Range	Flutes	Accuracy	α
3590-455A	25-45mm/1.0-1.8"	5	$\pm 5\mu\text{m}$	108°
3590-655A	45-65mm/1.8-2.6"	5	$\pm 6\mu\text{m}$	108°
3590-855A	65-85mm/2.6-3.4"	5	$\pm 6\mu\text{m}$	108°
3590-1055A	85-105mm/3.4-4.2"	5	$\pm 6\mu\text{m}$	108°
3590-257A	5-25mm/0.2-1.0"	7	$\pm 4\mu\text{m}$	128°34'17"
3590-457A	25-45mm/1.0-1.8"	7	$\pm 4\mu\text{m}$	128°34'17"
3590-657A	45-65mm/1.8-2.6"	7	$\pm 5\mu\text{m}$	128°34'17"
3590-857A	65-85mm/2.6-3.4"	7	$\pm 5\mu\text{m}$	128°34'17"

NON-ROTATING SPINDLE UNIVERSAL MICROMETERS

NON-ROTATING
SPINDLE

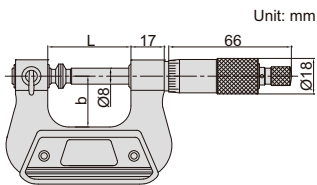

3280-25A

- Meet DIN863-3
- Graduation 0.01mm
- Non-rotating spindle
- Ratchet stop
- Supplied with 7 pairs of anvil/spindle tip
- Setting standards are included (except 0-25mm)
- Optional accessory: 55° anvil/spindle tip (code 3280-SP1 and 3280-SP2)

Code	Range	Accuracy	L	b
3280-25A	0-25mm	4 μm	42mm	26mm
3280-50A	25-50mm	4 μm	67mm	38mm
3280-75A	50-75mm	5 μm	92mm	50mm
3280-100A	75-100mm	5 μm	118mm	62mm
3280-125A	100-125mm	6 μm	143mm	70mm
3280-150A	125-150mm	6 μm	168mm	82mm
3280-175A	150-175mm	7 μm	192mm	95mm
3280-200A	175-200mm	7 μm	217mm	107mm

Anvil/spindle tip (included)

Unit: mm

Flat		
Spherical		
Spline		
Disk		
Blade		
Knife-edge		
Point		

55° anvil/spindle tip (optional)

Unit: mm

Code 3280-SP1 Knife-edge		
Code 3280-SP2 Point		

DATA
OUTPUT

NON-ROTATING
SPINDLE

DIGITAL UNIVERSAL MICROMETERS

- Resolution 0.001mm/0.00005"
- Non-rotating spindle
- Button function: on/off, set, mm/inch, ABS/INC
- Data output
- LR44 battery, automatic power off
- Ratchet stop
- Supplied with 7 pairs of anvil/spindle tip (same as series 3280)
- Setting standards are included (except 0-25mm/0-1")
- Optional accessory: 55° anvil/spindle tip code **3280-SP1** and **3280-SP2** (same as series 3280), data output cable (code 7315-, 7302-, 7305-)



3580-25A

Code	Range	Accuracy	L	b
3580-25A	0-25mm/0-1"	±4μm	42mm	26mm
3580-50A	25-50mm/1-2"	±4μm	67mm	38mm
3580-75A	50-75mm/2-3"	±5μm	92mm	50mm
3580-100A	75-100mm/3-4"	±5μm	118mm	62mm
3580-125A	100-125mm/4-5"	±6μm	143mm	70mm
3580-150A	125-150mm/5-6"	±6μm	168mm	82mm
3580-175A	150-175mm/6-7"	±7μm	192mm	95mm
3580-200A	175-200mm/7-8"	±7μm	217mm	107mm

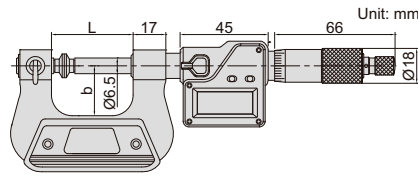

supplied with 7 pairs
of anvil/spindle tip
(same as series 3280)



ATTENTION: LOW PARALLELISM
OF TWO MEASURING FACES

- Meet DIN863-3
- Measure root tangent length of gear
- Graduation 0.01mm
- Ratchet stop
- Supplied with setting standards

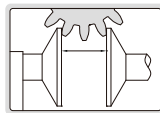

DISK MICROMETERS (ECONOMIC TYPE)



3282-25

(mm)

Code	Range	Accuracy	Parallelism	L	b	c
3282-25	0-25mm	4μm	5μm	34	24	3.3
3282-50	25-50mm	4μm	5μm	59	32	3.3
3282-75	50-75mm	5μm	5μm	85	45	3.3
3282-100	75-100mm	5μm	5μm	110	57	3.3

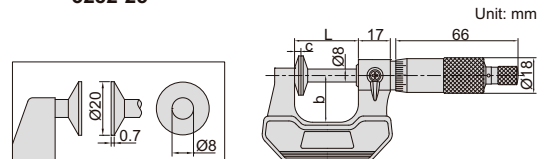

ATTENTION: LOW PARALLELISM
OF TWO MEASURING FACES

NON-ROTATING
SPINDLE

- Meet DIN863-3
- Measure root tangent length of gear
- Graduation 0.01mm
- Non-rotating spindle
- Ratchet stop
- Supplied with setting standards

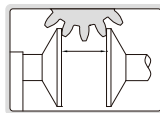

NON-ROTATING SPINDLE DISK MICROMETERS (ECONOMIC TYPE)



3294-25

(mm)

Code	Range	Accuracy	Parallelism	L	b
3294-25	0-25mm	4μm	5μm	34	24
3294-50	25-50mm	4μm	5μm	59	32
3294-75	50-75mm	5μm	5μm	85	45
3294-100	75-100mm	5μm	5μm	110	57

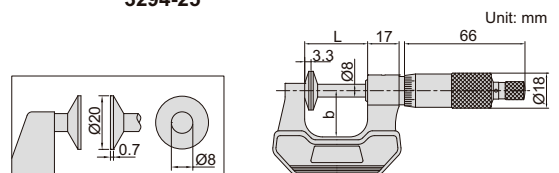

DIGITAL NON-ROTATING SPINDLE DISK MICROMETERS (ECONOMIC TYPE)

ATTENTION: LOW PARALLELISM OF TWO MEASURING FACES

DATA OUTPUT

NON-ROTATING SPINDLE

5

- Measure root tangent length of gear
- Resolution 0.001mm/0.00005"
- Non-rotating spindle
- Button function: on/off, set, mm/inch, ABS/INC
- Data output
- LR44 battery, automatic power off
- Ratchet stop
- Supplied with setting standards
- Optional accessory: data output cable (code 7315-, 7302-, 7305-)



3594-25A

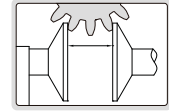

Code	Range	Accuracy	Parallelism	L	b
3594-25A	0-25mm/0-1"	±4μm	5μm	43mm	32mm
3594-50A	25-50mm/1-2"	±4μm	5μm	68mm	44.5mm
3594-75A	50-75mm/2-3"	±5μm	5μm	93mm	57mm
3594-100A	75-100mm/3-4"	±5μm	5μm	118.5mm	70mm

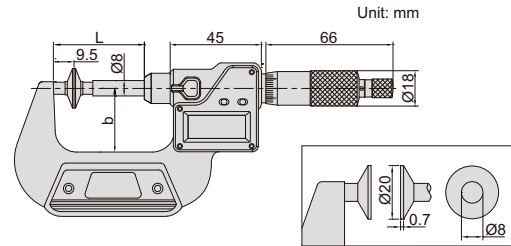

CALIPER TYPE MICROMETERS

- Graduation 0.01mm
- Non-rotating spindle
- Ratchet stop
- Carbide measuring faces
- Supplied with setting standards (except 0-25mm)



3238-25

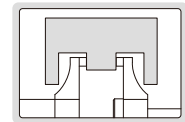

Code	Range	Accuracy	L
3238-25	0-25mm	5μm	56mm
3238-50	25-50mm	6μm	81mm
3238-75	50-75mm	7μm	106mm
3238-100	75-100mm	8μm	131mm

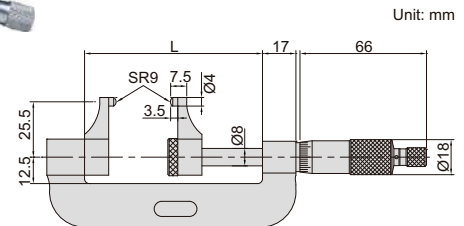

DIGITAL CALIPER TYPE MICROMETERS

DATA OUTPUT



3538-25

Code	Range	Accuracy	L
3538-25	0-25mm/0-1"	±5μm	56mm
3538-50	25-50mm/1-2"	±6μm	81mm
3538-75	50-75mm/2-3"	±7μm	106mm
3538-100	75-100mm/3-4"	±8μm	131mm

- Resolution: 0.001mm/0.00005"
- Non-rotating spindle
- Buttons: on/off, data set, mm/in, ABS/INC
- Data output
- LR44 battery, automatic power off
- Ratchet friction thimble
- Carbide measuring faces
- Supplied with setting standards (except 0-25mm/0-1")
- Optional accessory: data output cable (code 7315-, 7302-, 7305-)

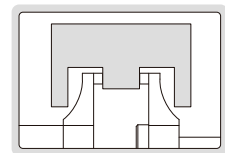
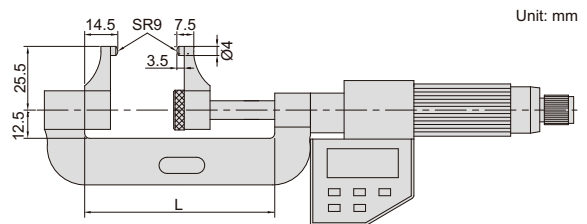

SHEET METAL MICROMETER

- Meet DIN863-3
- Measure thickness of sheet metal, paper, plastic and rubber parts
- Graduation 0.01mm
- Ratchet stop
- Carbide measuring faces

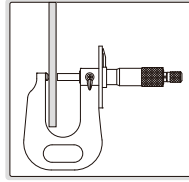

3263-25A

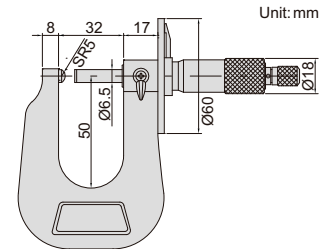

Code	Range	Accuracy
3263-25A	0-25mm	4µm

5

MICROMETERS FOR HOT PLATE

- Measure thickness of hot rolling sheet metal
- Carbide measuring faces
- Supplied with setting standard (except 0-15mm)



3264-15

Code	Range	Graduation	Accuracy
3264-15	0-15mm	0.05mm	0.05mm
3264-30	15-30mm	0.05mm	0.05mm
3264-45	30-45mm	0.05mm	0.05mm
3264-60	45-60mm	0.05mm	0.05mm
3264-75	60-75mm	0.05mm	0.05mm
3264-90	75-90mm	0.05mm	0.05mm
3264-105	90-105mm	0.05mm	0.05mm

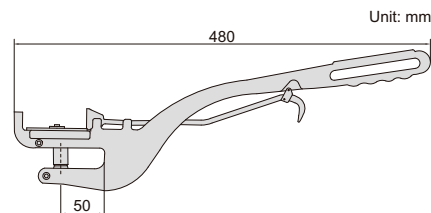

HUB MICROMETERS

- Meet DIN863-3
- Measure hub thickness and shoulder inside a bore
- Graduation 0.01mm
- Ratchet stop
- Carbide measuring faces
- Supplied with setting standards (except 0-25mm)



3292-25

Code	Range	Accuracy	h1	h2	H
3292-25	0-25mm	4µm	6	9	18.7
3292-50	25-50mm	4µm	6.5	11	21.2
3292-75	50-75mm	5µm	6.5	11	21.2
3292-100	75-100mm	5µm	6.5	11	21.2

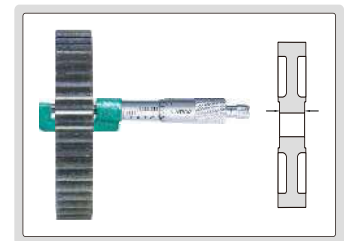
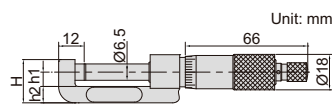

WIRE MICROMETER

- Meet DIN863-3
- Measure diameter of wires and small balls
- Graduation 0.01mm
- Ratchet stop
- Carbide measuring faces



3285-10

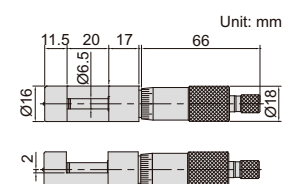

Code	Range	Accuracy
3285-10	0-10mm	4µm

CAN SEAM MICROMETERS



3293-131



3293-132



3293-133

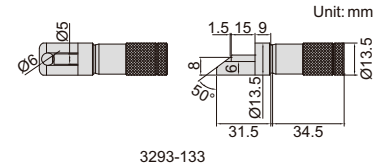
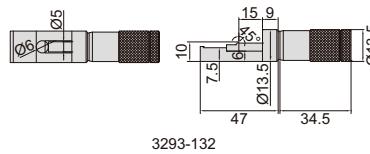
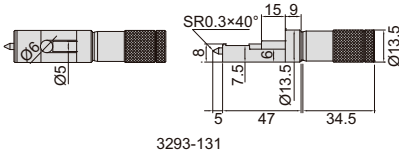

- Measure the width, height and depth of can seams
- Graduation 0.01mm

Code	Range	Accuracy
3293-131	0-13mm	4µm
3293-132	0-13mm	4µm
3293-133	0-13mm	4µm

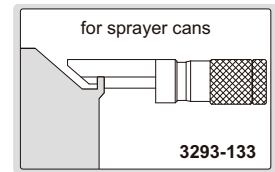
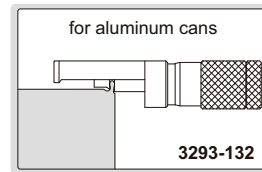
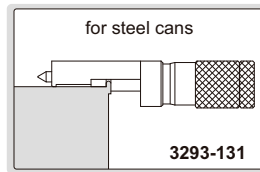

MICROMETER MEASURING FORCE DETECTOR

- For outside micrometers
0-25mm/0-1", 25-50mm/1-2",
50-75mm/2-3" and 75-100mm/3-4"

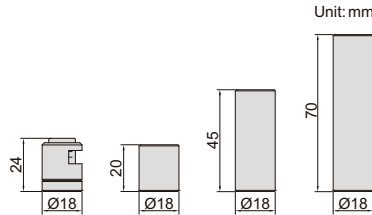

6315

Code	Measuring force
6315	5-12N

OPTICAL PARALLELS



4184-41A

- Check the flatness and parallelism of measuring faces of micrometer
- Flatness of A and B: 0.1µm
- Parallelism between A and B: 0.6µm

Code	Parallels included (b)	ØD	Applicable micrometer
4184-41A	15.62mm, 15.75mm, 15.87mm, 16.00mm	30mm	0-25mm
4184-42A	40.62mm, 40.75mm, 40.87mm, 41.00mm	30mm	25-50mm
4184-43B	65.62mm, 65.75mm, 65.87mm, 66.00mm	40mm	50-75mm
4184-44B	90.62mm, 90.75mm, 90.87mm, 91.00mm	50mm	75-100mm

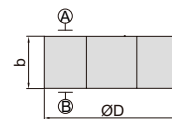

MICROMETER GRINDING MACHINE CODE 6307

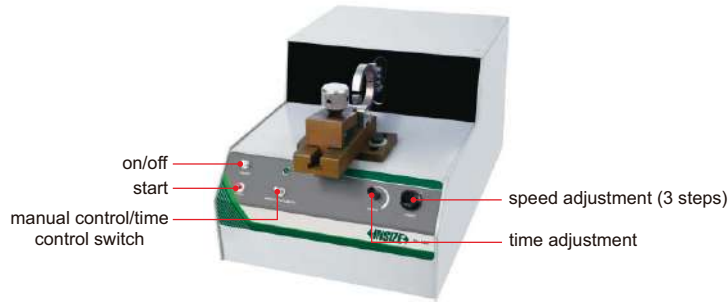

grinding blocks (code: 6307-1, optional)



5

- Used for grinding micrometer measuring surfaces
- Suitable for 0~100mm range micrometers

SPECIFICATION

Power supply	220V, 50HZ
Dimension (L×W×H)	450×260×220mm
Weight	30kg

GRINDING BLOCKS (optional)

Code	For micrometer	Remark
6307-1	0~25mm	includes 4 grinding blocks
6307-2	25~50mm	includes 4 grinding blocks
6307-3	50~75mm	includes 4 grinding blocks
6307-4	75~100mm	includes 4 grinding blocks

MICROMETER STAND

- Suitable for micrometers up to 100mm

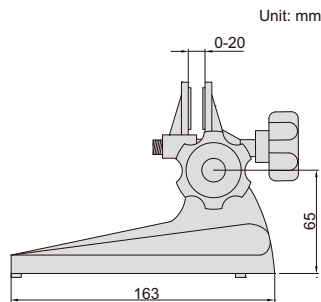

6301

Code

6301

- Suitable for inside micrometers

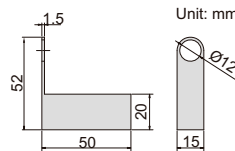

6301-1

Code	Description	Applicable products
6301-1	clamp for inside micrometers	all sizes of 3220 series

- Suitable for three points internal micrometers

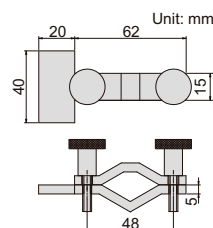

6301-2

Code	Description	Applicable products
6301-2	clamp for three points internal micrometers	up to 100mm of 3127 and 3227 series

MICROMETER STAND

- Suitable for micrometers up to 100mm

Code
6300

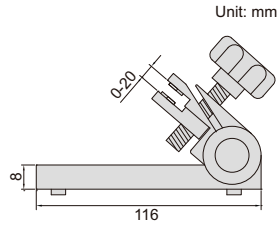

6300



5

MICROMETER SETTING STANDARDS



6310-100



type A



6310-300

Code	Length	Type	Accuracy	D
6310-25	25	A	±1.5µm	Ø7
6310-50	50	A	±2µm	Ø7
6310-75	75	A	±2.5µm	Ø7
6310-100	100	A	±3µm	Ø8
6310-125	125	A	±3.5µm	Ø8
6310-150	150	A	±4µm	Ø8
6310-175	175	A	±4.5µm	Ø8
6310-200	200	A	±5µm	Ø8
6310-225	225	A	±5.5µm	Ø8
6310-250	250	A	±6µm	Ø8
6310-275	275	A	±6.5µm	Ø8
6310-300	300	B	±7µm	Ø16
6310-325	325	B	±7.5µm	Ø16
6310-350	350	B	±8µm	Ø16
6310-375	375	B	±8.5µm	Ø16

Code	Length	Type	Accuracy	D
6310-400	400	B	±9µm	Ø16
6310-425	425	B	±9.5µm	Ø16
6310-450	450	B	±10µm	Ø16
6310-475	475	B	±10.5µm	Ø16
6310-500	500	B	±11µm	Ø16
6310-525	525	B	±11.5µm	Ø16
6310-575	575	B	±12.5µm	Ø16
6310-625	625	B	±13.5µm	Ø16
6310-675	675	B	±14.5µm	Ø16
6310-725	725	B	±15.5µm	Ø16
6310-775	775	B	±16.5µm	Ø16
6310-825	825	B	±17.5µm	Ø16
6310-875	875	B	±18.5µm	Ø16
6310-925	925	B	±19.5µm	Ø16
6310-975	975	B	±20.5µm	Ø16

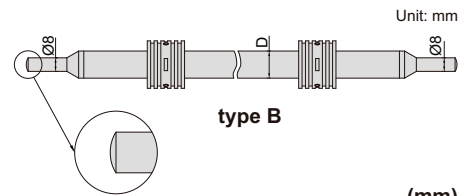

type B

Code	Length	Type	Accuracy	D
6310-1050	1050	B	±22µm	Ø23
6310-1150	1150	B	±24µm	Ø23
6310-1250	1250	B	±26µm	Ø23
6310-1350	1350	B	±28µm	Ø23
6310-1450	1450	B	±30µm	Ø23
6310-1550	1550	B	±32µm	Ø23
6310-1650	1650	B	±34µm	Ø23
6310-1750	1750	B	±36µm	Ø23
6310-1850	1850	B	±38µm	Ø23
6310-1950	1950	B	±40µm	Ø23

DIGITAL MICROMETER HEADS

- Resolution 0.001mm/0.00005"
- IP65 dust/waterproof
- Button function: on/off, set, mm/inch, ABS/INC
- Data output
- LR44 battery, automatic power off
- Ratchet stop
- Optional accessory: data output cable (code 7315-, 7302-, 7305-)



6353-25W

IP65
WATERPROOF

DATA
OUTPUT

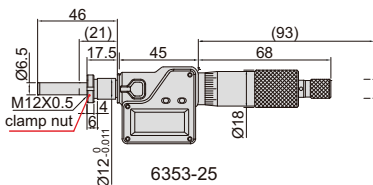

6353-25

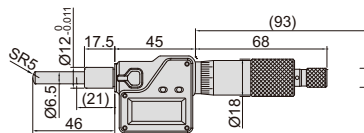

6353-25WS

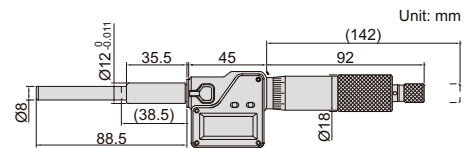

6353-50W

Rotating spindle

Code	Range	Stem	Spindle tip	Accuracy
6353-25	0-25mm/0-1"	with clamp nut	flat (carbide)	±2µm
6353-25W	0-25mm/0-1"	plain	flat (carbide)	±2µm
6353-25S	0-25mm/0-1"	with clamp nut	spherical (SR5)	±2µm
6353-25WS	0-25mm/0-1"	plain	spherical (SR5)	±2µm
6353-50W	0-50mm/0-2"	plain	flat (carbide)	±4µm

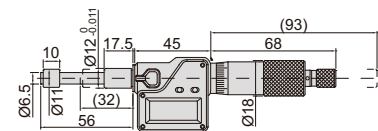

6354-25W

Non-rotating spindle

Code	Range	Stem	Spindle tip	Accuracy
6354-25W	0-25mm/0-1"	plain	flat	±2µm

SMALL MICROMETER HEAD

- Graduation 0.02mm

Code	Range	Stem	Spindle tip	Accuracy
6372-5WS	0-5mm	plain	spherical (SR1.5)	5µm



6372-5WS

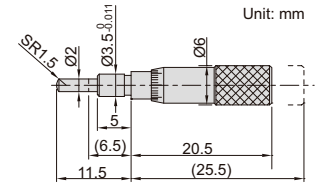

5

SMALL MICROMETER HEADS

- Range 0-6.5mm
- Graduation 0.01mm
- Accuracy 5µm



6385-65W

Code	Stem	Spindle tip
6385-65	with clamp nut	flat
6385-65W	plain	flat
6385-65S	with clamp nut	spherical (SR3)
6385-65WS	plain	spherical (SR3)

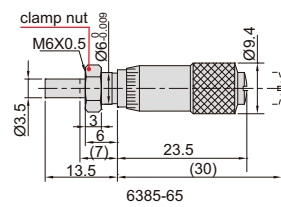

6385-65

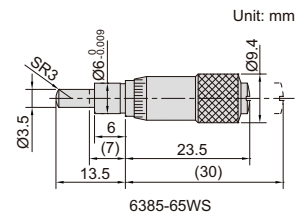

6385-65WS

LARGE THIMBLE MICROMETER HEADS

- Meet DIN863-2
- Large thimble diameter for easy reading
- Graduation 0.01mm
- Accuracy 3µm

Code	Range	Stem	Spindle tip
6373-65	0-6.5mm	with clamp nut	flat
6373-65W	0-6.5mm	plain	flat
6373-65S	0-6.5mm	with clamp nut	spherical (SR3)
6373-65WS	0-6.5mm	plain	spherical (SR3)
6373-13	0-13mm	with clamp nut	flat
6373-13W	0-13mm	plain	flat

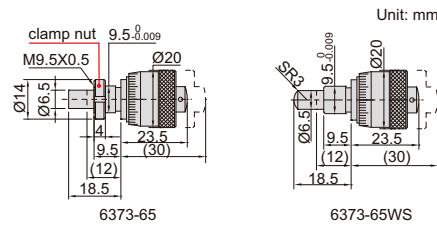

6373-65

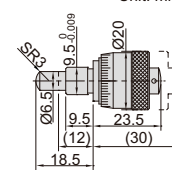

6373-65WS



6373-65

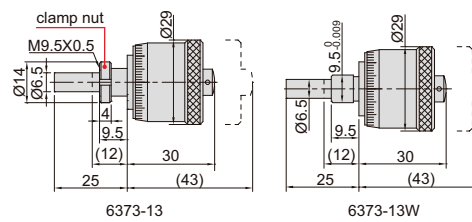

6373-13

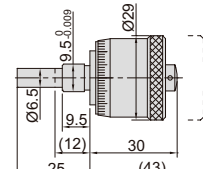

6373-13W



6373-13

MICROMETER HEADS WITH ZERO ADJUSTABLE THIMBLE

- Meet DIN863-2
- Range 0-13mm
- Graduation 0.01mm
- Accuracy 3µm
- The thimble can be set to zero at any position

Code	Stem	Spindle tip
6384-13	with clamp nut	flat
6384-13W	plain	flat

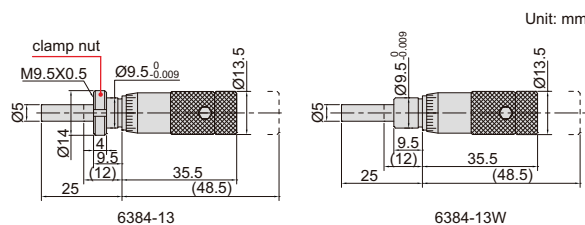

6384-13

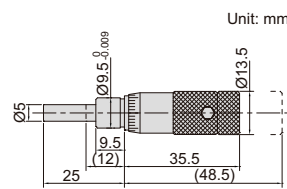

6384-13W



6384-13W

MICROMETER HEADS



6386-13W

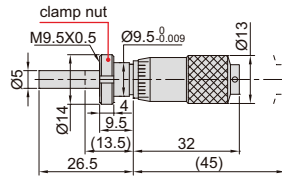

6386-13

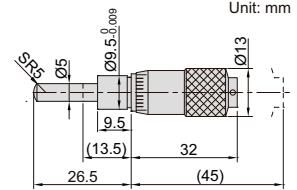

6386-13WS



6386-13P

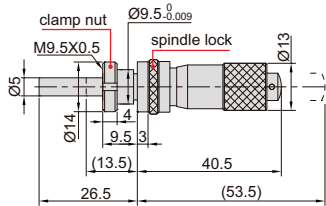

6386-13P

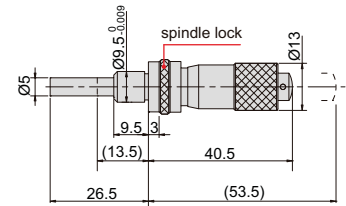

6386-13WP

Unit: mm

Code	Range	Stem	Spindle tip	Remark	Accuracy
6386-13	0-13mm	with clamp nut	flat		3µm
6386-13W	0-13mm	plain	flat		3µm
6386-13S	0-13mm	with clamp nut	spherical (SR5)		3µm
6386-13WS	0-13mm	plain	spherical (SR5)		3µm
6386-13P	0-13mm	with clamp nut	flat	with spindle lock	3µm
6386-13WP	0-13mm	plain	flat	with spindle lock	3µm

- Meet DIN863-2
- Graduation 0.01mm

MICROMETER HEADS

- Meet DIN863-2
- Graduation 0.01mm
- Accuracy 3µm



6387-15WS

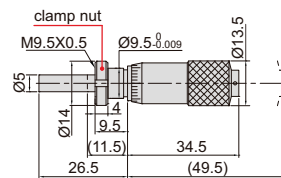

6387-15

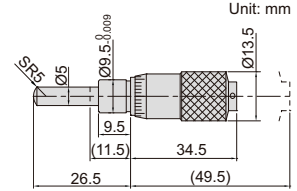

6387-15WS

Unit: mm

Code	Range	Stem	Spindle tip
6387-15	0-15mm	with clamp nut	flat
6387-15W	0-15mm	plain	flat
6387-15S	0-15mm	with clamp nut	spherical (SR5)
6387-15WS	0-15mm	plain	spherical (SR5)

MICROMETER HEADS



6381-25



6381-25P

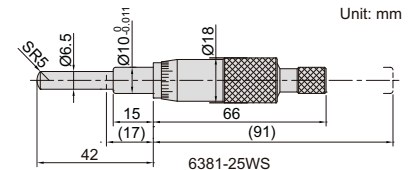

6381-25WS

Unit: mm

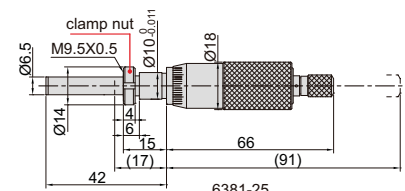

6381-25

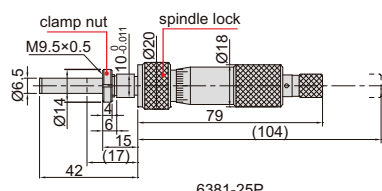

6381-25P

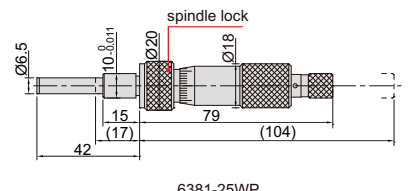

6381-25WP

Code	Range	Stem	Spindle tip	Remark	Accuracy
6381-25	0-25mm	with clamp nut	flat (carbide)		3µm
6381-25W	0-25mm	plain	flat (carbide)		3µm
6381-25S	0-25mm	with clamp nut	spherical (SR5)		3µm
6381-25WS	0-25mm	plain	spherical (SR5)		3µm
6381-25P	0-25mm	with clamp nut	flat (carbide)	with spindle lock	3µm
6381-25WP	0-25mm	plain	flat (carbide)	with spindle lock	3µm

- Meet DIN863-2
- Graduation 0.01mm
- Ratchet stop

NON-ROTATING SPINDLE MICROMETER HEAD

- Meet DIN863-2
- Graduation 0.01mm
- Ratchet stop
- Non-rotating spindle



6377-25W

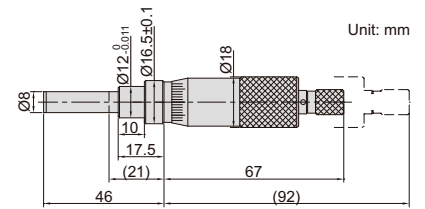

Code	Range	Stem	Spindle tip	Accuracy
6377-25W	0-25mm	plain	flat (carbide)	3µm

LARGE MICROMETER HEADS



6388-50AW

- Graduation 0.01mm
- Ratchet stop

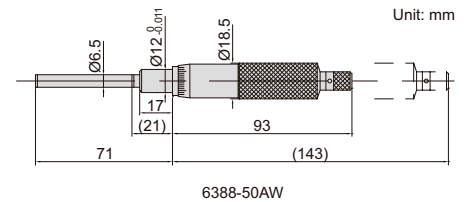
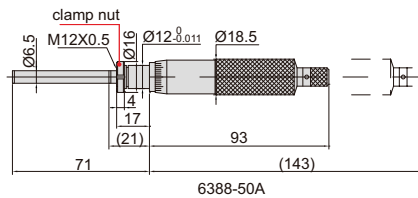

Code	Range	Stem	Spindle tip	Accuracy
6388-50A	0-50mm	with clamp nut	flat (carbide)	5µm
6388-50AW	0-50mm	plain	flat (carbide)	5µm

QUICK SPINDLE FEEDING MICROMETER HEADS



6375-50W



6375-25W



6375-15W

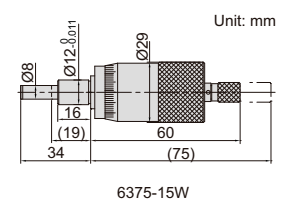
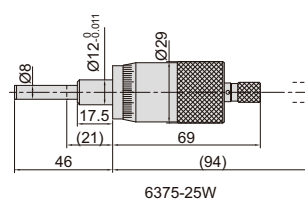
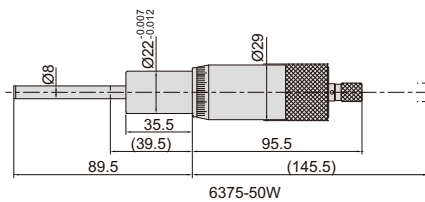

Code	Range	Stem	Spindle tip	Accuracy
6375-15W	0-15mm	plain	flat (carbide)	3µm
6375-25W	0-25mm	plain	flat (carbide)	3µm
6375-50W	0-50mm	plain	flat (carbide)	5µm

- Micrometers up to 25mm meet DIN863-2
- Graduation 0.01mm
- Quick spindle feed of 1mm/rev.
- Ratchet stop

PISTOL GRIP THREE POINTS BORE GAGES

INSPECTION CERTIFICATE

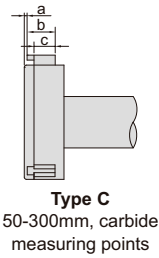
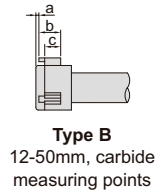
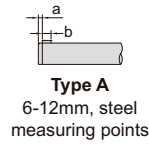
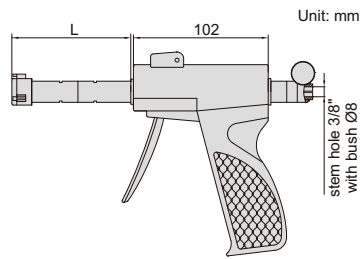

- Optional accessory:
digital indicators (code **2108-101F**, resolution 0.001mm/0.00005"),
setting rings (code **6312**)



6-100mm: included
100-300mm: optional



included

Individual

(mm)

Code	Range	Type	Accuracy (without digital indicator)	Setting ring	Extension rod (included)	L	a	b	c
2124-8 *	6-8mm	A	4µm	Ø6mm (included)	100mm	50	1.5	2.5	—
2124-10 *	8-10mm	A	4µm	Ø8mm (included)	100mm	50	1.5	2.5	—
2124-12 *	10-12mm	A	4µm	Ø10mm (included)	100mm	50	1.5	2.5	—
2124-16 *	12-16mm	B	4µm	Ø16mm (included)	150mm	65	0.5	6	4.5
2124-20 *	16-20mm	B	4µm	Ø16mm (included)	150mm	65	0.5	6	4.5
2124-25 *	20-25mm	B	4µm	Ø25mm (included)	150mm	91	0.5	8	6
2124-30 *	25-30mm	B	4µm	Ø25mm (included)	150mm	91	0.5	8	6
2124-40 *	30-40mm	B	4µm	Ø40mm (included)	150mm	97	0.5	14	12
2124-50 *	40-50mm	B	5µm	Ø40mm (included)	150mm	97	0.5	14	12
2124-63 *	50-63mm	C	5µm	Ø62mm (included)	150mm	112	0.5	17.5	14.5
2124-75 *	62-75mm	C	5µm	Ø62mm (included)	150mm	112	0.5	17.5	14.5
2124-88 *	75-88mm	C	5µm	Ø87mm (included)	150mm	112	0.5	17.5	14.5
2124-100 *	87-100mm	C	5µm	Ø87mm (included)	150mm	112	0.5	17.5	14.5
2124-125 *	100-125mm	C	6µm	optional	150mm	140	0.9	29	25
2124-150 *	125-150mm	C	6µm	optional	150mm	140	0.9	29	25
2124-175 *	150-175mm	C	7µm	optional	150mm	140	0.9	29	25
2124-200 *	175-200mm	C	7µm	optional	150mm	140	0.9	29	25
2124-225	200-225mm	C	8µm	optional	150mm	140	0.9	29	25
2124-250	225-250mm	C	8µm	optional	150mm	140	0.9	29	25
2124-275	250-275mm	C	9µm	optional	150mm	140	0.9	29	25
2124-300	275-300mm	C	9µm	optional	150mm	140	0.9	29	25

Set

Code	Range	Probes included	Setting ring (included)	Extension rod (included)
2124-S123 *	6-12mm	6-8mm, 8-10mm, 10-12mm	Ø6mm, Ø8mm, Ø10mm	100mm
2124-S202 *	12-20mm	12-16mm, 16-20mm	Ø16mm	150mm
2124-S504 *	20-50mm	20-25mm, 25-30mm, 30-40mm, 40-50mm	Ø25mm, Ø40mm	150mm
2124-S1004 *	50-100mm	50-63mm, 62-75mm, 75-88mm, 87-100mm	Ø62mm, Ø87mm	150mm



2124- S504

* Supplied with manufacturer inspection certificate

TWO POINTS/THREE POINTS INTERNAL MICROMETERS

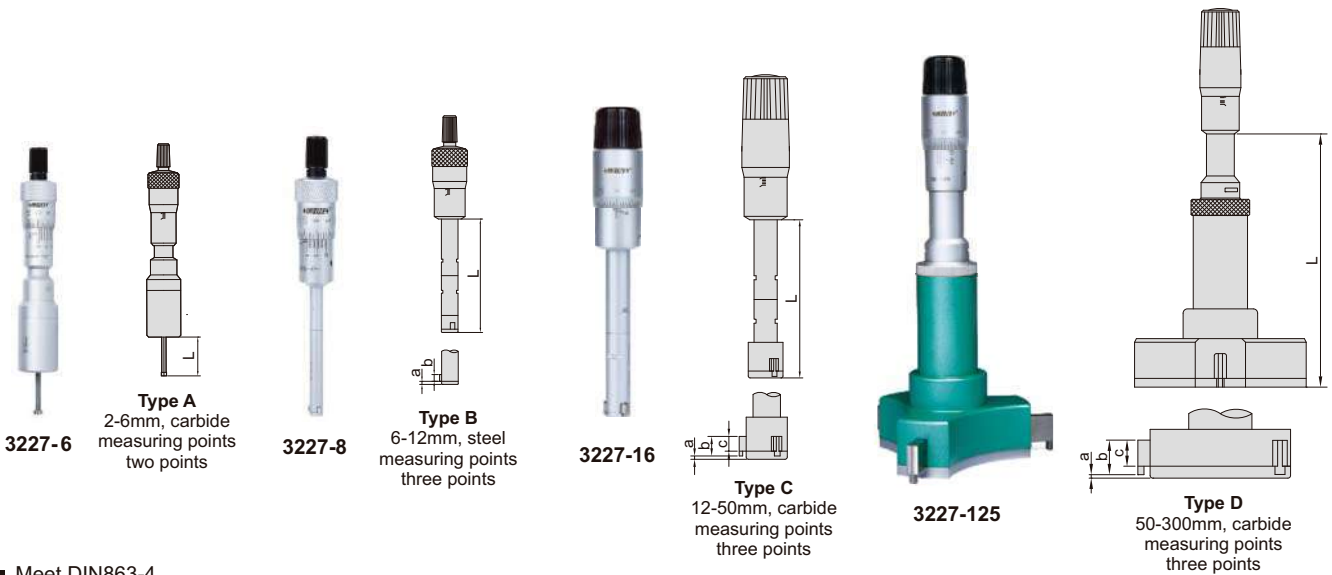

- Meet DIN863-4
- 2-12mm: graduation 0.001mm
12-300mm: graduation 0.005mm
- Ratchet stop
- Optional accessory: setting rings (code **6312**),
micrometer stand and clamp (code **6301** and **6301-2**)

Individual

(mm)

Code	Range	Type	Accuracy	Setting ring	Extension rod (included)	L	a	b	c
3227-2 *	2-2.5mm	A (two points)	6µm	Ø2.5 (included)	—	12	—	—	—
3227-3 *	2.5-3mm	A (two points)	6µm	Ø2.5 (included)	—	12	—	—	—
3227-4 *	3-4mm	A (two points)	6µm	Ø4 (included)	—	22	—	—	—
3227-5 *	4-5mm	A (two points)	6µm	Ø5 (included)	—	22	—	—	—
3227-6 *	5-6mm	A (two points)	6µm	Ø6 (included)	—	22	—	—	—
3227-8 *	6-8mm	B (three points)	4µm	Ø6 (included)	100	54.5	1.5	2.5	—
3227-10 *	8-10mm	B (three points)	4µm	Ø8 (included)	100	54.5	1.5	2.5	—
3227-12 *	10-12mm	B (three points)	4µm	Ø10 (included)	100	54.5	1.5	2.5	—
3227-16 *	12-16mm	C (three points)	4µm	Ø16 (included)	150	80	0.5	6	4.5
3227-20 *	16-20mm	C (three points)	4µm	Ø16 (included)	150	80	0.5	6	4.5
3227-25 *	20-25mm	C (three points)	4µm	Ø25 (included)	150	90	0.5	8	6
3227-30 *	25-30mm	C (three points)	4µm	Ø25 (included)	150	90	0.5	8	6
3227-40 *	30-40mm	C (three points)	4µm	Ø40 (included)	150	97	0.5	14	12
3227-50 *	40-50mm	C (three points)	5µm	Ø40 (included)	150	97	0.5	14	12
3227-63 *	50-63mm	D (three points)	5µm	Ø62 (included)	150	114	0.5	17.5	14.5
3227-75 *	62-75mm	D (three points)	5µm	Ø62 (included)	150	114	0.5	17.5	14.5
3227-88 *	75-88mm	D (three points)	5µm	Ø87 (included)	150	114	0.5	17.5	14.5
3227-100 *	87-100mm	D (three points)	5µm	Ø87 (included)	150	114	0.5	17.5	14.5
3227-125 *	100-125mm	D (three points)	6µm	optional	150	140	0.9	29	25
3227-150 *	125-150mm	D (three points)	6µm	optional	150	140	0.9	29	25
3227-175 *	150-175mm	D (three points)	7µm	optional	150	140	0.9	29	25
3227-200 *	175-200mm	D (three points)	7µm	optional	150	140	0.9	29	25
3227-225	200-225mm	D (three points)	8µm	optional	150	140	0.9	29	25
3227-250	225-250mm	D (three points)	8µm	optional	150	140	0.9	29	25
3227-275	250-275mm	D (three points)	9µm	optional	150	140	0.9	29	25
3227-300	275-300mm	D (three points)	9µm	optional	150	140	0.9	29	25

To be continued

Continued from previous page

micrometer stand with clamp (optional)



setting ring



2-100mm: included
100-300mm: optional

extension rod

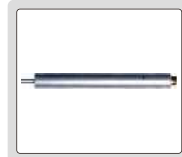

included



3227-504

Set

Code	Range	Micrometers included	Setting ring (included)	Extension rod (included)
3227-232 *	2-3mm	2-2.5mm, 2.5-3mm	Ø2.5mm	—
3227-363 *	3-6mm	3-4mm, 4-5mm, 5-6mm	Ø4mm, Ø5mm, Ø6mm	—
3227-123 *	6-12mm	6-8mm, 8-10mm, 10-12mm	Ø6mm, Ø8mm, Ø10mm	100mm
3227-202 *	12-20mm	12-16mm, 16-20mm	Ø16mm	150mm
3227-504 *	20-50mm	20-25mm, 25-30mm, 30-40mm, 40-50mm	Ø25mm, Ø40mm	150mm
3227-1004 *	50-100mm	50-63mm, 62-75mm, 75-88mm, 87-100mm	Ø62mm, Ø87mm	150mm

* Supplied with manufacturer inspection certificate

DIGITAL TWO POINTS/THREE POINTS INTERNAL MICROMETERS



IP65
WATERPROOF

DATA
OUTPUT



3127-5

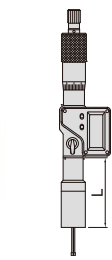

Type A
2-6mm, carbide measuring points two points



3127-12

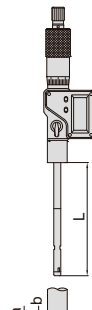

Type B
6-12mm, steel measuring points



3127-40

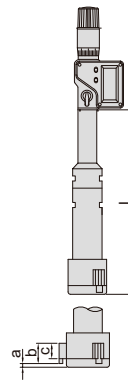

Type C
12-50mm, carbide measuring points



3127-125

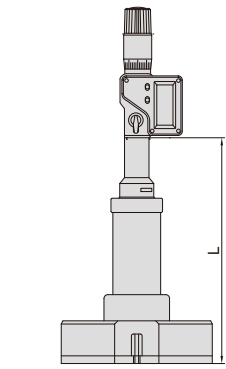

Type D
50-300mm, carbide measuring points

- Resolution 0.001mm/0.00005" (3127-275 and 3127-300 is 0.001mm/0.0001")
- IP65 dust/waterproof
- Buttons: on/off, set, mm/inch, ABS/INC
- Data output
- LR44 battery, automatic power off
- Ratchet stop
- Optional accessory: data output cable (code 7315-, 7302-, 7305-), setting ring (code 6312), micrometer stand and clamp (code 6301 and 6301-2)

To be continued

Continued from previous page

micrometer stand
with clamp (optional)



setting ring



2-100mm: included
100-300mm: optional

extension rod



included



3127-202

Individual

(mm)

Code	Range	Type	Accuracy	Setting ring	Extension rod (included)	L	a	b	c
3127-2 *	2-2.5mm/0.08-0.10"	A (two points)	6µm	Ø2.5 (included)	—	12	—	—	—
3127-3 *	2.5-3mm/0.10-0.12"	A (two points)	6µm	Ø2.5 (included)	—	12	—	—	—
3127-4 *	3-4mm/0.12-0.16"	A (two points)	6µm	Ø4 (included)	—	22	—	—	—
3127-5 *	4-5mm/0.16-0.20"	A (two points)	6µm	Ø5 (included)	—	22	—	—	—
3127-6 *	5-6mm/0.20-0.24"	A (two points)	6µm	Ø6 (included)	—	22	—	—	—
3127-8 *	6-8mm/0.24-0.31"	B (three points)	4µm	Ø6 (included)	100	57	1.5	2.5	—
3127-10 *	8-10mm/0.31-0.39"	B (three points)	4µm	Ø8 (included)	100	57	1.5	2.5	—
3127-12 *	10-12mm/0.39-0.47"	B (three points)	4µm	Ø10 (included)	100	57	1.5	2.5	—
3127-16 *	12-16mm/0.47-0.63"	C (three points)	4µm	Ø16 (included)	150	99	0.5	6	4.5
3127-20 *	16-20mm/0.63-0.79"	C (three points)	4µm	Ø16 (included)	150	99	0.5	6	4.5
3127-25 *	20-25mm/0.79-0.98"	C (three points)	4µm	Ø25 (included)	150	105	0.5	8	6
3127-30 *	25-30mm/0.98-1.18"	C (three points)	4µm	Ø25 (included)	150	105	0.5	8	6
3127-40 *	30-40mm/1.18-1.57"	C (three points)	4µm	Ø40 (included)	150	110	0.5	14	12
3127-50 *	40-50mm/1.57-1.97"	C (three points)	5µm	Ø40 (included)	150	110	0.5	14	12
3127-63 *	50-63mm/1.97-2.48"	D (three points)	5µm	Ø62 (included)	150	127	0.5	17.5	14.5
3127-75 *	62-75mm/2.44-2.95"	D (three points)	5µm	Ø62 (included)	150	127	0.5	17.5	14.5
3127-88 *	75-88mm/2.95-3.46"	D (three points)	5µm	Ø87 (included)	150	127	0.5	17.5	14.5
3127-100 *	87-100mm/3.43-3.94"	D (three points)	5µm	Ø87 (included)	150	127	0.5	17.5	14.5
3127-125 *	100-125mm/3.94-4.92"	D (three points)	6µm	optional	150	175	0.9	29	25
3127-150 *	125-150mm/4.92-5.91"	D (three points)	6µm	optional	150	175	0.9	29	25
3127-175 *	150-175mm/5.91-6.89"	D (three points)	7µm	optional	150	175	0.9	29	25
3127-200 *	175-200mm/6.89-7.87"	D (three points)	7µm	optional	150	175	0.9	29	25
3127-225	200-225mm/7.87-8.86"	D (three points)	8µm	optional	150	175	0.9	29	25
3127-250	225-250mm/8.86-9.84"	D (three points)	8µm	optional	150	175	0.9	29	25
3127-275	250-275mm/9.84-10.83"	D (three points)	9µm	optional	150	175	0.9	29	25
3127-300	275-300mm/10.83-11.81"	D (three points)	9µm	optional	150	175	0.9	29	25

Set

Code	Range	Micrometers included	Setting ring (included)	Extension rod (included)
3127-232 *	2-3mm/0.08-0.12"	2-2.5mm, 2.5-3mm	Ø2.5mm	—
3127-363 *	3-6mm/0.12-0.24"	3-4mm, 4-5mm, 5-6mm	Ø4mm, Ø5mm, Ø6mm	—
3127-123 *	6-12mm/0.24-0.47"	6-8mm, 8-10mm, 10-12mm	Ø6mm, Ø8mm, Ø10mm	100mm
3127-202 *	12-20mm/0.47-0.79"	12-16mm, 16-20mm	Ø16mm	150mm
3127-504 *	20-50mm/0.79-1.97"	20-25mm, 25-30mm, 30-40mm, 40-50mm	Ø25mm, Ø40mm	150mm
3127-1004 *	50-100mm/1.97-3.94"	50-63mm, 62-75mm, 75-88mm, 87-100mm	Ø62mm, Ø87mm	150mm

* Supplied with manufacturer inspection certificate

WIDE RANGE THREE POINTS INTERNAL MICROMETERS

- Meet DIN863-4
- Graduation 0.001mm
- Carbide measuring faces
- Ratchet stop
- Setting rings are included (except 200-300mm)



Code	Range	Accuracy	Setting ring
3228-70*	50-70mm	5µm	Ø50mm (included)
3228-100*	70-100mm	5µm	Ø70mm (included)
3228-150*	100-150mm	6µm	Ø100mm (included)
3228-250*	150-250mm	8µm	Ø150mm (included)
3228-300*	200-300mm	9µm	Ø200mm (optional)



setting ring



3228-70

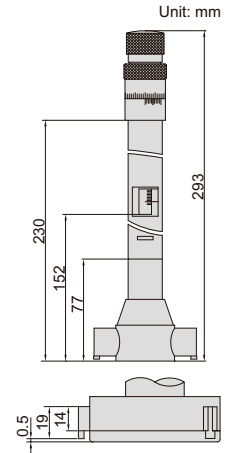

*Supplied with manufacturer inspection certificate

6

DIGITAL WIDE RANGE THREE POINTS INTERNAL MICROMETERS

IP54
WATERPROOF

DATA
OUTPUT

- Meet DIN863-4
- Resolution 0.001mm/0.00005" (resolution of 3128-300 is 0.001mm/0.0001")
- IP54 dust/waterproof
- Buttons: on/off, set, mm/inch, ABS/INC
- Data output
- LR44 battery, automatic power off
- Carbide measuring faces
- Ratchet stop
- Supplied with extension rods
- Setting rings are included (except 200-300mm)
- Optional accessory: data output cable (code 7315-, 7302-, 7305-)



setting ring



extension rod (included)



3128-70

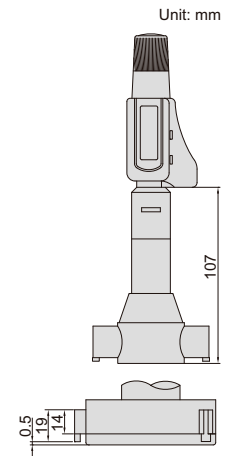

Code	Range	Accuracy	Setting ring	Extension rod (included)
3128-70*	50-70mm/1.97-2.76"	5µm	Ø50mm (included)	150mm
3128-100*	70-100mm/2.76-3.94"	5µm	Ø70mm (included)	150mm
3128-150*	100-150mm/3.94-5.91"	6µm	Ø100mm (included)	150mm
3128-250*	150-250mm/5.91-9.84"	8µm	Ø150mm (included)	150mm
3128-300*	200-300mm/7.87-11.81"	9µm	Ø200mm (optional)	150mm

*Supplied with manufacturer inspection certificate

INSIDE MICROMETERS (ECONOMIC TYPE)

ATTENTION: LOW PARALLELISM OF TWO MEASURING FACES

- Graduation 0.01mm
- Ratchet stop
- Carbide measuring faces
- Optional accessory: setting ring (code 6312), micrometer stand and clamp (code 6301 and 6301-1)

micrometer stand with clamp (optional)



Unit: mm

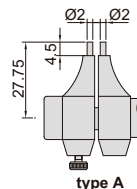

type A



3220-50

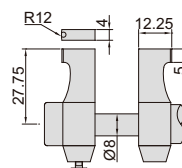

type B

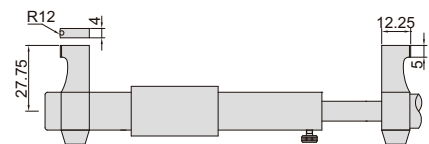

type C

Code	Range	Type	Setting ring	Accuracy
3220-30	5-30mm	A	5mm (included)	7µm
3220-50	25-50mm	B	25mm (included)	8µm
3220-75	50-75mm	B	50mm (optional)	9µm
3220-100	75-100mm	C	75mm (optional)	10µm

DATA
OUTPUT

ATTENTION: LOW PARALLELISM
OF TWO MEASURING FACES

DIGITAL INSIDE MICROMETERS (ECONOMIC TYPE)

- Resolution 0.001mm/0.00005"
- Button function: on/off, set, mm/inch, ABS/INC
- Data output
- LR44 battery, automatic power off
- Ratchet stop
- Carbide measuring faces
- Optional accessory: data output cable (code 7315-, 7302-, 7305-), setting ring (code 6312)



3520-30

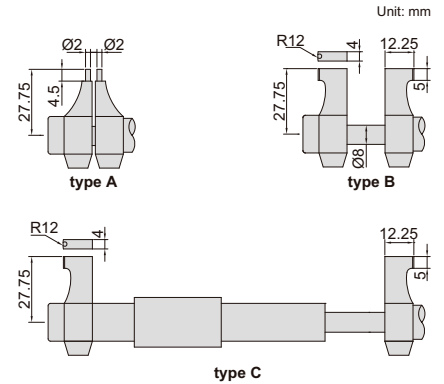

Code	Range	Type	Setting ring	Accuracy
3520-30	5-30mm/0.2-1.2"	A	5mm (included)	±5µm
3520-50	25-50mm/1-2"	B	25mm (included)	±6µm
3520-75	50-75mm/2-3"	B	50mm (optional)	±7µm
3520-100	75-100mm/3-4"	C	75mm (optional)	±8µm

INTERNAL SCREW THREAD MICROMETERS

INSIZE PLUS
MADE IN GERMANY

tips are optional

- Measure pitch diameter of screw thread
- Graduation 0.01mm
- Ratchet stop
- Optional accessory: measuring tips for internal screw thread micrometer (code 7385)



3640-45

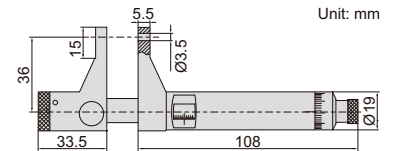

Code	Range	Accuracy	Applicable tips
3640-45	20-45mm	4µm	stem length L=5mm
3640-70	45-70mm	5µm	stem length L=5mm
3640-95	70-95mm	5µm	stem length L=13.5mm
3640-120	95-120mm	6µm	stem length L=13.5mm

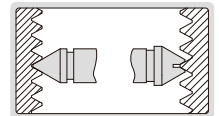

RELATIVE PRODUCT: GEAR
BORE GAGE (CODE 2428)

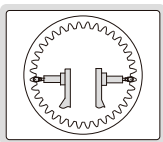

INTERNAL GEAR TOOTH MICROMETERS

INSIZE PLUS
MADE IN GERMANY

before ball tips
are installed



ball tips are optional

- Measure over-pin diameter of gears
- Graduation 0.01mm
- Ratchet stop
- Optional accessory: ball tips (code 7383)



3637-50

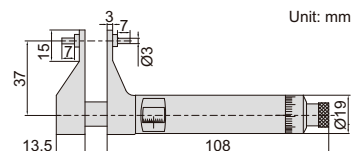

Code	Range	Accuracy
3637-50	25-50mm	4µm
3637-75	50-75mm	5µm

DIGITAL TUBULAR INSIDE MICROMETERS

IP65
WATERPROOF

DATA
OUTPUT



- Carbide measuring faces
- Graduation: 0.001mm/0.00005"
- Accuracy: $(3+n+L/50)\mu\text{m}$
n= number of rods
L=maximum measuring length (mm)
- The diameter of extension rods is 22mm
- IP65 dust/waterproof
- Button function: on/off, set, mm/inch, ABS/INC
- Data output
- LR44 battery, automatic power off
- Supplied with setting standards
- Optional accessory: data output cable (code 7315-, 7302-, 7305-)

3521-1000

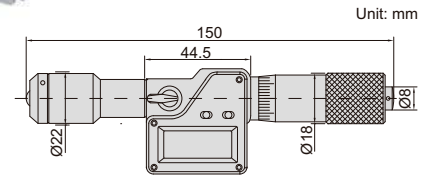

Code	Range	Travel of micrometer head	Extension rods
3521-175	150-175mm	25mm	—
3521-1000	150-1000mm	25mm	25mm, 50mm (2 pcs), 100mm, 200mm, 400mm
3521-1500	150-1500mm	25mm	25mm, 50mm (2 pcs), 100mm (2 pcs), 200mm, 400mm (2 pcs)
3521-2000	150-2000mm	25mm	25mm, 50mm (2 pcs), 100mm, 200mm (2 pcs), 400mm (3 pcs)

TUBULAR INSIDE MICROMETERS

- Micrometers up to 500mm meet DIN863-4
- Graduation 0.01mm
- Carbide measuring faces



3229-225

Code	Range	Type	Accuracy
3229-75	50-75mm	A	5 μm
3229-100	75-100mm	B	5 μm
3229-125	100-125mm	C	6 μm
3229-150	125-150mm	C	6 μm
3229-175	150-175mm	C	7 μm
3229-200	175-200mm	C	7 μm
3229-225	200-225mm	C	8 μm
3229-250	225-250mm	C	8 μm
3229-275	250-275mm	C	9 μm
3229-300	275-300mm	C	9 μm
3229-325	300-325mm	C	9 μm
3229-350	325-350mm	C	9 μm
3229-375	350-375mm	C	10 μm
3229-400	375-400mm	C	10 μm
3229-425	400-425mm	C	10 μm
3229-450	425-450mm	C	10 μm
3229-475	450-475mm	C	11 μm
3229-500	475-500mm	C	11 μm
3229-525	500-525mm	C	11 μm
3229-550	525-550mm	C	11 μm
3229-575	550-575mm	C	11 μm
3229-600	575-600mm	C	12 μm
3229-625	600-625mm	C	12 μm
3229-650	625-650mm	C	12 μm
3229-675	650-675mm	C	13 μm
3229-700	675-700mm	C	13 μm

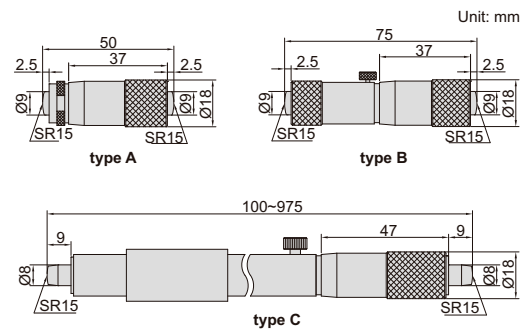

Code	Range	Type	Accuracy
3229-725	700-725mm	C	13 μm
3229-750	725-750mm	C	14 μm
3229-775	750-775mm	C	14 μm
3229-800	775-800mm	C	14 μm
3229-825	800-825mm	C	15 μm
3229-850	825-850mm	C	15 μm
3229-875	850-875mm	C	15 μm
3229-900	875-900mm	C	16 μm
3229-925	900-925mm	C	16 μm
3229-950	925-950mm	C	16 μm
3229-975	950-975mm	C	17 μm
3229-1000	975-1000mm	C	17 μm

TUBULAR INSIDE MICROMETERS

- Graduation 0.01mm
- Accuracy: $(6+L/50)\mu\text{m}$
L=maximum measuring length (mm)
- Optional accessory: setting ring (code 6312)



Code	Range	Travel of micrometer head	Extension rods
3221-32	25-32mm	7mm	—
3221-50	25-50mm	7mm	2 pcs
3221-63	50-63mm	13mm	—
3221-200	50-200mm	13mm	6 pcs
3221-300	50-300mm	13mm	10 pcs
3221-225	200-225mm	25mm	—
3221-500	200-500mm	25mm	3 pcs
3221-1000	200-1000mm	25mm	8 pcs

3221-200

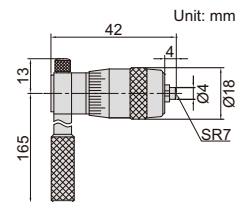

TUBULAR INSIDE MICROMETERS

- Graduation 0.01mm
- Accuracy: $(3+n+L/50)\mu\text{m}$
n=number of rods
L=maximum measuring length (mm)
- Supplied with setting standards
- Carbide measuring faces



3222-150

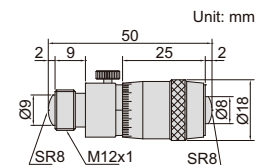

Code	Range	Travel of micrometer head	Extension rods
3222-63	50-63mm	13mm	—
3222-150	50-150mm	13mm	13mm, 25mm, 50mm
3222-300	50-300mm	13mm	13mm, 25mm, 50mm (2 pcs), 100mm
3222-500	50-500mm	13mm	13mm, 25mm, 50mm (2 pcs), 100mm, 200mm
3222-600	50-600mm	13mm	13mm, 25mm, 50mm, 100mm, 150mm, 200mm
3222-1000	50-1000mm	13mm	13mm, 25mm, 50mm (2 pcs), 100mm, 200mm (2 pcs), 300mm
3222-1500	50-1500mm	13mm	13mm, 25mm, 50mm (2 pcs), 100mm, 200mm (3 pcs), 300mm (2 pcs)

TUBULAR INSIDE MICROMETERS

- Graduation 0.01mm
- Accuracy: $(3+n+L/50)\mu\text{m}$
n=number of rods
L=maximum measuring length (mm)
- Travel of micrometer head 25mm
- Supplied with setting standards
- Carbide measuring faces

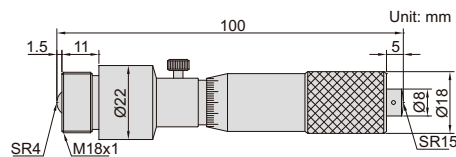

Code	Range	Extension rods
3225-125	100-125mm	—
3225-500	100-500mm	25mm, 50mm, 100mm, 200mm
3225-900	100-900mm	25mm, 50mm, 100mm, 200mm, 400mm
3225-1300	100-1300mm	25mm, 50mm, 100mm, 200mm, 400mm (2 pcs)
3225-1700	100-1700mm	25mm, 50mm, 100mm, 200mm, 400mm (3 pcs)
3225-2100	100-2100mm	25mm, 50mm, 100mm, 200mm, 400mm (4 pcs)



3225-500

TUBULAR INSIDE MICROMETERS



3224-2000

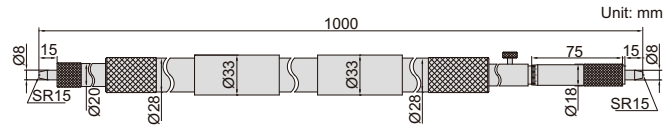

6

Code	Range	Extension rods
3224-2000	1000-2000mm	50mm, 100mm (2 pcs), 200mm, 500mm
3224-3000	1000-3000mm	50mm, 100mm (2 pcs), 200mm, 500mm, 1000mm
3224-4000	1000-4000mm	50mm, 100mm (2 pcs), 200mm, 500mm, 1000mm (2 pcs)
3224-5000	1000-5000mm	50mm, 100mm (2 pcs), 200mm, 500mm, 1000mm (3 pcs)

- Graduation 0.01mm
- Accuracy: $(7+n+L/50)\mu\text{m}$
n=number of rods
L=maximum measuring length (mm)
- Travel of micrometer head 50mm
- Carbide measuring faces

DIGITAL NON-ROTATING SPINDLE TUBULAR INSIDE MICROMETERS

INSIZE PLUS
MADE IN GERMANY



3635-950

DATA OUTPUT

SPRING LOADED MEASURING POINT

NON-ROTATING SPINDLE

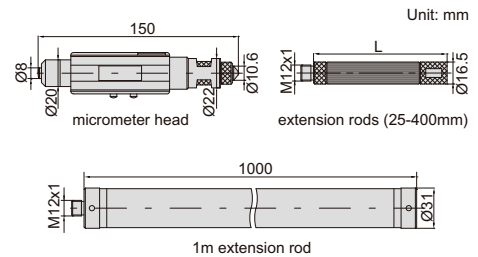

- Micrometer head: 150-175mm
- Carbide measuring faces for micrometer head and extension rods
- Points of extension rods are spring loaded
- Data output
- Button function: mm/inch, max./min. value tracking, tolerance measurement, hold, on/off, zero
- CR2032 battery, automatic power off

Extension rods

Length (L)	Accuracy	Weight	Material
25mm	$\pm 1.25\mu\text{m}$	37g	steel
50mm	$\pm 1.25\mu\text{m}$	65g	steel
100mm	$\pm 2\mu\text{m}$	113g	steel
200mm	$\pm 3.5\mu\text{m}$	208g	steel
400mm	$\pm 4.5\mu\text{m}$	402g	steel
1000mm	$\pm 7.5\mu\text{m}$	909g	carbon fiber

Micrometer head

Range	Resolution	Accuracy	Repeatability	Measuring force	Weight
150-175mm	0.001mm/0.00005" 0.01mm/0.0005" (switchable)	$\pm 4\mu\text{m}$	1 μm	5-10N	275g

1m carbon fiber extension rod, light weight, no deform

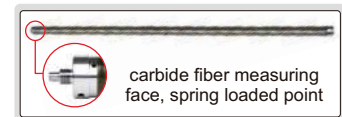

Code	Range	Extension rods
3635-350	150-350mm	25mm, 50mm, 100mm
3635-550	150-550mm	25mm, 50mm, 100mm, 200mm
3635-950	150-950mm	25mm, 50mm, 100mm, 200mm, 400mm
3635-1550	150-1550mm	25mm, 50mm, 100mm, 200mm (2 pcs), 400mm (2 pcs)
3635-2150	150-2150mm	25mm, 50mm, 100mm, 200mm, 400mm (4 pcs)
3635-3150	150-3150mm	25mm, 50mm, 100mm, 200mm (2 pcs), 400mm, 1000mm (2 pcs)
3635-4150	150-4150mm	25mm, 50mm, 100mm, 200mm (2 pcs), 400mm, 1000mm (3 pcs)
3635-5150	150-5150mm	25mm, 50mm, 100mm, 200mm (2 pcs), 400mm, 1000mm (4 pcs)
3635-6150	150-6150mm	25mm, 50mm, 100mm, 200mm (2 pcs), 400mm, 1000mm (5 pcs)

non-rotating spindle, spring loaded point and max./min. value tracking make it easy to find the right measuring position

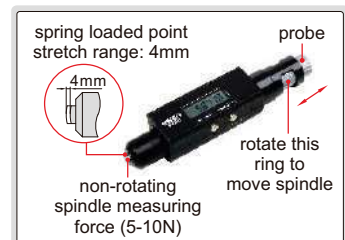

TUBULAR INSIDE MICROMETERS

INSIZE PLUS
MADE IN GERMANY

- Micrometer head: 100-125mm
- Carbide measuring faces for micrometer head and extension rods
- Points of extension rods are spring loaded



3634-1300

Micrometer head

Range	Graduation	Accuracy	Weight
100-125mm	0.01mm	±4µm	154g

Extension rods

Length (L)	Accuracy	Weight	Material
25mm	±1.25µm	37g	steel
50mm	±1.25µm	65g	steel
100mm	±2µm	113g	steel
200mm	±3.5µm	208g	steel
400mm	±4.5µm	402g	steel
1000mm	±7.5µm	909g	carbon fiber

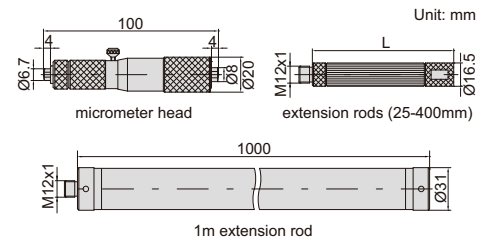

Code	Range	Extension rods
3634-350	100-350mm	25mm, 200mm
3634-500	100-500mm	25mm, 50mm, 100mm, 200mm
3634-1300	100-1300mm	25mm, 50mm, 100mm, 200mm, 400mm (2 pcs)
3634-1500	100-1500mm	25mm, 50mm, 100mm, 200mm (2 pcs), 400mm (2 pcs)
3634-2100	100-2100mm	25mm, 50mm, 100mm, 200mm, 400mm (4 pcs)
3634-3100	100-3100mm	25mm, 50mm, 100mm, 200mm (2 pcs), 400mm, 1000mm (2 pcs)
3634-4100	100-4100mm	25mm, 50mm, 100mm, 200mm (2 pcs), 400mm, 1000mm (3 pcs)
3634-5100	100-5100mm	25mm, 50mm, 100mm, 200mm (2 pcs), 400mm, 1000mm (4 pcs)
3634-6100	100-6100mm	25mm, 50mm, 100mm, 200mm (2 pcs), 400mm, 1000mm (5 pcs)

1m carbon fiber extension rod,
light weight, no deform

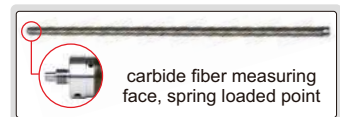

RELATIVE PRODUCT:
GEAR BORE GAGE (CODE 2428)

INTERNAL GEAR TOOTH MICROMETERS

INSIZE PLUS
MADE IN GERMANY

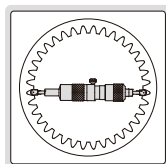

3638-200

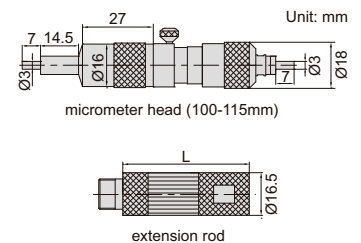

- Measure over-pin diameter of gears
- Points of extension rods are spring loaded
- Optional accessory: ball tips (code 7383)

Micrometer head

Range	Graduation	Accuracy
100-115mm	0.01mm	±4µm
150-175mm	0.01mm	±4µm

Extension rod

Length (L)	Accuracy
15mm	±1µm
25mm	±1.25µm
30mm	±1.25µm
50mm	±1.25µm
100mm	±2µm
200mm	±3.5µm
400mm	±4.5µm

Code	Range	Micrometer head	Extension rod (L)
3638-200	100-205mm	100-115mm	15mm, 25mm, 50mm
3638-500	100-505mm	100-115mm	15mm, 25mm, 50mm, 100mm, 200mm
3638-900	100-905mm	100-115mm	15mm, 25mm, 50mm, 100mm, 200mm, 400mm
3638-1100	150-1150mm	150-175mm	25mm, 50mm, 100mm, 200mm, 200mm, 400mm

INTERNAL SCREW THREAD MICROMETERS

INSIZE PLUS
MADE IN GERMANY

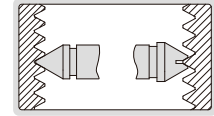
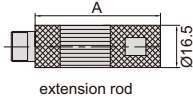
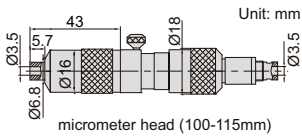

6

3641-200

Extension rod

- Measure pitch diameter of screw thread
- Points of extension rods are spring loaded
- Optional accessory: measuring tips for internal screw thread micrometer (code 7385, L=13.5mm)

Micrometer head

Range	Graduation	Accuracy
100-115mm	0.01mm	±4μm
150-175mm	0.01mm	±4μm

Length (A)	Accuracy
15mm	±1μm
25mm	±1.25μm
50mm	±1.25μm
100mm	±2μm
200mm	±3.5μm
400mm	±4.5μm

Code	Range	Micrometer head	Extension rod (A)	Applicable tips
3641-200	100-205mm	100-115mm	15mm, 25mm, 50mm	stem length L=13.5mm
3641-500	100-505mm	100-115mm	15mm, 25mm, 50mm, 100mm, 200mm	stem length L=13.5mm
3641-900	100-905mm	100-115mm	15mm, 25mm, 50mm, 100mm, 200mm, 400mm	stem length L=13.5mm
3641-1100	150-1150mm	150-175mm	25mm, 50mm, 100mm, 200mm, 200mm, 400mm	stem length L=13.5mm

INTERNAL SCREW THREAD MICROMETERS

- Graduation: 0.01mm
- Optional accessory: measuring tips for internal screw thread micrometer (code 7321)



3226-1001

Code	Range	Code	Range
3226-1001	75-100mm	3226-2251	200-225mm
3226-1251	100-125mm	3226-2501	225-250mm
3226-1501	125-150mm	3226-2751	250-275mm
3226-1751	150-175mm	3226-3001	275-300mm
3226-2001	175-200mm		

measuring tips for internal screw thread micrometer (optional)



MEASURING TIPS FOR INTERNAL SCREW THREAD MICROMETERS

- Supplied in pair
- Suitable for 3226 series micrometers

Metric and unified screw (60° thread angle)

Code	Pitch
7321-T11	0.4-0.5mm/64-48TPI
7321-T12	0.6-0.9mm/44-28TPI
7321-T13	1-1.75mm/24-14TPI
7321-T14	2-3mm/13-9TPI
7321-T15	3.5-5mm/8-5TPI
7321-T16	5.5-7mm /4.5-3.5TPI
7321-T1S	6 pairs/set, including all above tips



7321-T1S

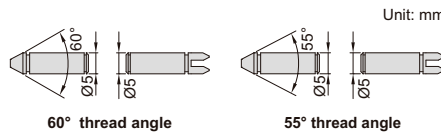

Whitworth screw (55° thread angle)

Code	Pitch
7321-T21	60-48TPI
7321-T22	48-40TPI
7321-T23	40-32TPI
7321-T24	32-24TPI
7321-T25	24-18TPI
7321-T26	18-14TPI
7321-T27	14-10TPI
7321-T28	10-7TPI
7321-T29	7-4.5TPI
7321-T210	4.5-3.5TPI
7321-T2S	10 pairs/set, including all above tips

BORE PLUG GAGES

INSIZE PLUS
MADE IN GERMANY

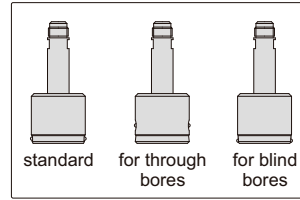
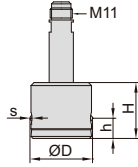

principle of measurement

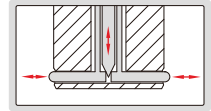

SPECIFICATION OF PROBE

	(mm)								
Range	2-3	3.1-4	4.1-6	6.1-9	9.1-12	12.1-20	20.1-40	40.1-60	60.1-130
Travel of point (s)	0.15	0.15	0.15	0.2	0.2	0.2	0.2	0.2	0.2
Height of point (h)	standard	1	1.5	1.5	2.5	2.5	2.5	3.5	4
	for through bores	—	6	6	6	10	10	10	10
for blind bores	0.7	1	1	1	1	1	1.2	1.2	1.2
Height of probe (H)	17.5	26	10	15	15	15	20	28	33
Repeatability	0.001	0.001	0.001	0.0005	0.0005	0.0005	0.0005	0.0005	0.001

PROBE AND SLEEVE

Code	Type
4653-A□□□□	standard
4653-B□□□□	for through bores
4653-C□□□□	for blind bores

Ordering examples: (mm)

Code	Type	Range
4653-A30D6H7*	standard	30.6H7

* "D" stands for "."



DEPTH STOP

Code	Applicable for probe
4653-G□□□□	3.0~60mm
4653-J□□□□	30~130mm

Ordering examples: (mm)

Code	Applicable for probe
4653-G22H7	22H7

SETTING RING

Code
6312-□□□□□



HANDLE

Code	Length (L)	Retraction
4653-150	45mm	without
4653-1105	105mm	without
4653-1235	235mm	without
4653-H70	70mm	with

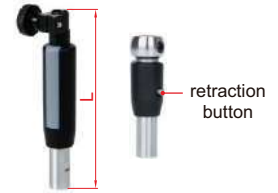

EXTENSION ROD FOR HANDLE

Code	Length (H)
4653-R50	50mm
4653-R100	100mm
4653-R250	250mm
4653-R500	500mm

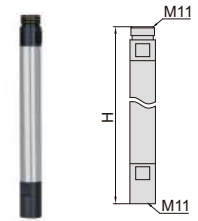

90° ADAPTER

Code
4653-K1

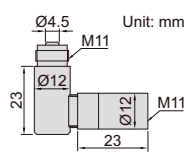

Unit: mm

application



set measuring depth



HANDLE FOR INDUCTIVE PROBE

Code
4653-F110



application

- For split type dial bore gages 2421, 2426, 2427 and 2429
- Maximum working stroke: 90mm
- Accept dial indicator to show measuring depth

Code
2491-250



STAND FOR SPLIT DIAL BORE GAGES

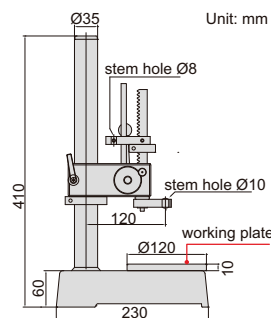

Unit: mm

accept dial indicator to show measuring depth



SPLIT TYPE DIAL BORE GAGES

INSIZE PLUS
MADE IN GERMANY

dial indicator
is optional



- Split type contact points
- Accuracy (without indicator):
3µm (measuring range 0.95~10mm),
4µm (measuring range 10~20.6mm)
- Repeatability (without indicator): 1µm
- Optional accessory:
digital/dial indicators or dial comparator

principle of measurement

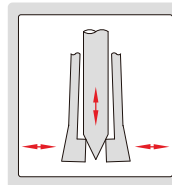

6

(mm)



contact point

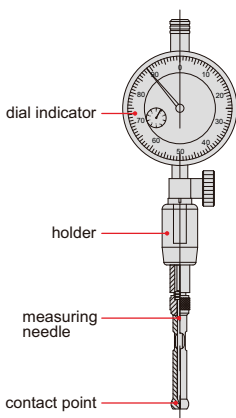

Unit: mm
stem hole Ø8

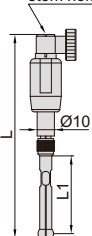

Code	Measuring range	Contact point			Material of points	Measuring needle		Setting ring	
		Measuring depth (L1)	Total length (L)	Code		Code	Diameter		
2426-1	0.95-1.15	13	89	carbide	2426-N1D4	2421-R1	1		
2426-1D1	1.07-1.25	13	89	carbide		2421-R1D1	1.1		
2426-1D2	1.17-1.35	13	89	carbide		2421-R1D2	1.2		
2426-1D3	1.27-1.45	13	89	carbide		2421-R1D3	1.3		
2426-1D4	1.37-1.55	13	89	carbide	2421-R1D4	1.4			
2426-1D75	1.5-1.9	17	93	carbide	2426-N2D25	2421-1D75	1.75		
2426-2	1.8-2.2	17	93	carbide		2421-2	2		
2426-2D25	2.05-2.45	17	93	carbide	2421-2D25	2.25			
2426-2D5	2.3-2.7	25	101	carbide	2426-N4	2421-2D5	2.5		
2426-2D75	2.55-2.95	25	101	carbide		2421-2D75	2.75		
2426-3	2.8-3.2	25	101	carbide		2421-3	3		
2426-3D25	3.05-3.45	25	101	carbide		2421-3D25	3.25		
2426-3D5	3.3-3.7	25	101	carbide	2421-3D5	3.5			
2426-3D75	3.55-3.95	25	101	carbide	2421-3D75	3.75			
2426-4	3.8-4.2	25	101	carbide	2421-4	4			
2426-4D5	4.15-4.8	41	118	hard chromed	2426-N9	2421-4D5	4.5		
2426-5	4.7-5.3	41	118	hard chromed		2421-5	5		
2426-5D5	5.2-5.8	41	118	hard chromed		2421-5D5	5.5		
2426-6	5.7-6.3	41	118	hard chromed		2421-6	6		
2426-6D5	6.2-6.8	41	118	hard chromed		2421-6D5	6.5		
2426-7	6.7-7.3	41	118	hard chromed		2421-7	7		
2426-7D5	7.2-7.8	45	118	hard chromed		2421-7D5	7.5		
2426-8	7.7-8.3	45	118	hard chromed		2421-8	8		
2426-8D5	8.2-8.8	45	118	hard chromed		2421-8D5	8.5		
2426-9	8.7-9.3	45	118	hard chromed	2421-9	9			
2426-10	9.2-10.5	45	118	hard chromed	2426-N20	2421-10	10		
2426-11	10.2-11.5	45	118	hard chromed		2421-11	11		
2426-12	11.2-12.5	45	118	hard chromed		2421-12	12		
2426-13	12.2-13.5	45	118	hard chromed		2421-13	13		
2426-14	13.4-14.6	45	118	hard chromed		2421-14	14		
2426-15	14.4-15.6	45	118	hard chromed		2421-15	15		
2426-16	15.4-16.6	45	118	hard chromed		2421-16	16		
2426-17	16.4-17.6	45	118	hard chromed		2421-17	17		
2426-18	17.4-18.6	45	118	hard chromed		2421-18	18		
2426-19	18.4-19.6	45	118	hard chromed		2421-19	19		
2426-20	19.4-20.6	45	118	hard chromed	2421-20	20			



HOLDER

Code	Retraction	Applicable points
2426-HOLDER1	without	all
2426-HOLDER2	with	all

SPLIT TYPE DIAL BORE GAGE SETS

INSIZE PLUS
MADE IN GERMANY

- Split type contact points
- Accuracy (without indicator):
3µm (measuring range 0.95~10mm),
4µm (measuring range 10~20.6mm)
- Repeatability (without indicator): 1µm
- Setting rings and dial indicators are optional



2421-121

(mm)

Code	Range	Quantity of points	Measuring range of point	Measuring depth (L1)	Total length (L)	Material of points	Type of point	Setting ring (optional)	
								Code	Diameter
2421-1D4	0.95-1.55	5	0.95-1.15	13	89	carbide	A	2421-R1	1
			1.07-1.25	13	89	carbide	A	2421-R1D1	1.1
			1.17-1.35	13	89	carbide	A	2421-R1D2	1.2
			1.27-1.45	13	89	carbide	A	2421-R1D3	1.3
			1.37-1.55	13	89	carbide	A	2421-R1D4	1.4
2421-4	1.5-4.2	10	1.5-1.9	17	93	carbide	A	2421-1D75	1.75
			1.8-2.2	17	93	carbide	A	2421-2	2
			2.05-2.45	17	93	carbide	A	2421-2D25	2.25
			2.3-2.7	25	101	carbide	A	2421-2D5	2.5
			2.55-2.95	25	101	carbide	A	2421-2D75	2.75
			2.8-3.2	25	101	carbide	A	2421-3	3
			3.05-3.45	25	101	carbide	A	2421-3D25	3.25
			3.3-3.7	25	101	carbide	A	2421-3D5	3.5
			3.55-3.95	25	101	carbide	A	2421-3D75	3.75
			3.8-4.2	25	101	carbide	A	2421-4	4
2421-7D5	4.15-7.8	7	4.15-4.8	41	118	hard chromed	B	2421-4D5	4.5
			4.7-5.3	41	118	hard chromed	B	2421-5	5
			5.2-5.8	41	118	hard chromed	B	2421-5D5	5.5
			5.7-6.3	41	118	hard chromed	B	2421-6	6
			6.2-6.8	41	118	hard chromed	B	2421-6D5	6.5
			6.7-7.3	41	118	hard chromed	B	2421-7	7
			7.2-7.8	45	118	hard chromed	C	2421-7D5	7.5
2421-12	7.7-12.5	6	7.7-8.3	45	118	hard chromed	C	2421-8	8
			8.2-8.8	45	118	hard chromed	C	2421-8D5	8.5
			8.7-9.3	45	118	hard chromed	C	2421-9	9
			9.2-10.5	45	118	hard chromed	C	2421-10	10
			10.2-11.5	45	118	hard chromed	C	2421-11	11
			11.2-12.5	45	118	hard chromed	C	2421-12	12
2421-20	12.2-20.6	8	12.2-13.5	45	118	hard chromed	C	2421-13	13
			13.4-14.6	45	118	hard chromed	C	2421-14	14
			14.4-15.6	45	118	hard chromed	C	2421-15	15
			15.4-16.6	45	118	hard chromed	C	2421-16	16
			16.4-17.6	45	118	hard chromed	C	2421-17	17
			17.4-18.6	45	118	hard chromed	C	2421-18	18
			18.4-19.6	45	118	hard chromed	C	2421-19	19
			19.4-20.6	45	118	hard chromed	C	2421-20	20
2421-121	4.15-12.5	13	4.15-4.8	41	118	hard chromed	B	2421-4D5	4.5
			4.7-5.3	41	118	hard chromed	B	2421-5	5
			5.2-5.8	41	118	hard chromed	B	2421-5D5	5.5
			5.7-6.3	41	118	hard chromed	B	2421-6	6
			6.2-6.8	41	118	hard chromed	B	2421-6D5	6.5
			6.7-7.3	41	118	hard chromed	B	2421-7	7
			7.2-7.8	45	118	hard chromed	C	2421-7D5	7.5
			7.7-8.3	45	118	hard chromed	C	2421-8	8
			8.2-8.8	45	118	hard chromed	C	2421-8D5	8.5
			8.7-9.3	45	118	hard chromed	C	2421-9	9
			9.2-10.5	45	118	hard chromed	C	2421-10	10
			10.2-11.5	45	118	hard chromed	C	2421-11	11
			11.2-12.5	45	118	hard chromed	C	2421-12	12

principle of measurement

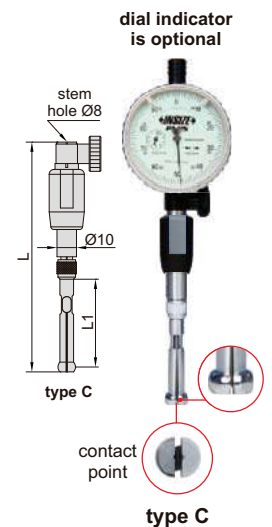
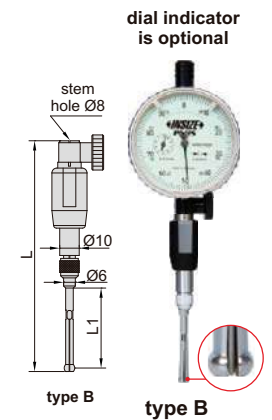
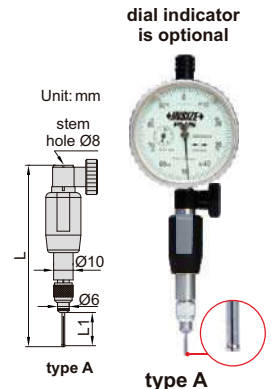
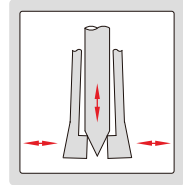

SPLIT TYPE DIAL BORE GAGES FOR BLIND HOLES

INSIZE PLUS
MADE IN GERMANY

6

dial indicator
is optional



contact point

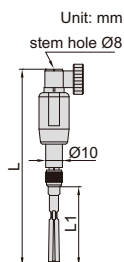
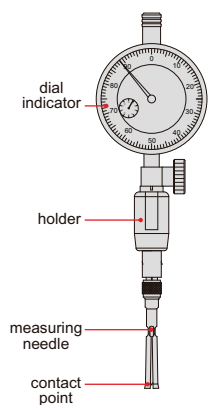

2426-HOLDER1



retraction
button

2426-HOLDER2

principle of measurement

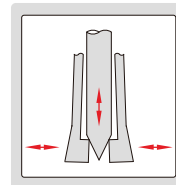

- Split type contact points
- Accuracy (without indicator):
3µm (measuring range 1.5~10mm),
4µm (measuring range 10~20.6mm)
- Repeatability (without indicator): 1µm
- Optional accessory:
digital/dial indicators or dial comparator

(mm)

Code	Contact point				Material of points	Measuring needle		Setting ring	
	Measuring range	Measuring depth (L1)	Total length (L)			Code	Code	Diameter	
2427-1D75	1.5-1.9	17	93		carbide	2426-N2D25	2421-R1D75	1.75	
2427-2	1.8-2.2	17	93		carbide		2421-R2	2	
2427-2D25	2.05-2.45	17	93		carbide		2421-R2D25	2.25	
2427-2D5	2.3-2.7	25	101		carbide	2426-N4	2421-R2D5	2.5	
2427-2D75	2.55-2.95	25	101		carbide		2421-R2D75	2.75	
2427-3	2.8-3.2	25	101		carbide		2421-R3	3	
2427-3D25	3.05-3.45	25	101		carbide		2421-R3D25	3.25	
2427-3D5	3.3-3.7	25	101		carbide		2421-R3D5	3.5	
2427-3D75	3.55-3.95	25	101		carbide		2421-R3D75	3.75	
2427-4	3.8-4.2	25	101		carbide		2421-R4	4	
2427-4D5	4.15-4.8	41	118		hard chromed	2427-N9	2421-R4D5	4.5	
2427-5	4.7-5.3	41	118		hard chromed		2421-R5	5	
2427-5D5	5.2-5.8	41	118		hard chromed		2421-R5D5	5.5	
2427-6	5.7-6.3	41	118		hard chromed		2421-R6	6	
2427-6D5	6.2-6.8	41	118		hard chromed		2421-R6D5	6.5	
2427-7	6.7-7.3	41	118		hard chromed		2421-R7	7	
2427-7D5	7.2-7.8	45	118		hard chromed		2421-R7D5	7.5	
2427-8	7.7-8.3	45	118		hard chromed		2421-R8	8	
2427-8D5	8.2-8.8	45	118		hard chromed		2421-R8D5	8.5	
2427-9	8.7-9.3	45	118		hard chromed		2421-R9	9	
2427-10	9.2-10.5	45	118		hard chromed	2427-N20	2421-R10	10	
2427-11	10.2-11.5	45	118		hard chromed		2421-R11	11	
2427-12	11.2-12.5	45	118		hard chromed		2421-R12	12	
2427-13	12.2-13.5	45	118		hard chromed		2421-R13	13	
2427-14	13.4-14.6	45	118		hard chromed		2421-R14	14	
2427-15	14.4-15.6	45	118		hard chromed		2421-R15	15	
2427-16	15.4-16.6	45	118		hard chromed		2421-R16	16	
2427-17	16.4-17.6	45	118		hard chromed		2421-R17	17	
2427-18	17.4-18.6	45	118		hard chromed		2421-R18	18	
2427-19	18.4-19.6	45	118		hard chromed		2421-R19	19	
2427-20	19.4-20.6	45	118		hard chromed	2421-R20	20		

HOLDER

Code	Retraction	Applicable points
2426-HOLDER1	without	all
2426-HOLDER2	with	all

SPLIT TYPE DIAL BORE GAGE SETS FOR BLIND HOLES

INSIZE PLUS
MADE IN GERMANY

- Split type contact points
- Accuracy (without indicator):
3µm (measuring range 1.5~10mm),
4µm (measuring range 10~20.6mm)
- Repeatability (without indicator): 1µm
- Setting rings and dial indicators are optional



2429-4

(mm)

Code	Range	Quantity of points	Measuring range of point	Measuring depth (L1)	Total length (L)	Material of points	Setting ring (optional)	
							Code	Diameter
2429-4	1.5-4.2	10	1.5-1.9	17	93	carbide	2421-R1D75	1.75
			1.8-2.2	17	93	carbide	2421-R2	2
			2.05-2.45	17	93	carbide	2421-R2D25	2.25
			2.3-2.7	25	101	carbide	2421-R2D5	2.5
			2.55-2.95	25	101	carbide	2421-R2D75	2.75
			2.8-3.2	25	101	carbide	2421-R3	3
			3.05-3.45	25	101	carbide	2421-R3D25	3.25
			3.3-3.7	25	101	carbide	2421-R3D5	3.5
			3.55-3.95	25	101	carbide	2421-R3D75	3.75
			3.8-4.2	25	101	carbide	2421-R4	4
2429-7D5	4.15-7.8	7	4.15-4.8	41	118	hard chromed	2421-R4D5	4.5
			4.7-5.3	41	118	hard chromed	2421-R5	5
			5.2-5.8	41	118	hard chromed	2421-R5D5	5.5
			5.7-6.3	41	118	hard chromed	2421-R6	6
			6.2-6.8	41	118	hard chromed	2421-R6D5	6.5
			6.7-7.3	41	118	hard chromed	2421-R7	7
			7.2-7.8	45	118	hard chromed	2421-R7D5	7.5
2429-12	7.7-12.5	6	7.7-8.3	45	118	hard chromed	2421-R8	8
			8.2-8.8	45	118	hard chromed	2421-R8D5	8.5
			8.7-9.3	45	118	hard chromed	2421-R9	9
			9.2-10.5	45	118	hard chromed	2421-R10	10
			10.2-11.5	45	118	hard chromed	2421-R11	11
			11.2-12.5	45	118	hard chromed	2421-R12	12
2429-20	12.2-20.6	8	12.2-13.5	45	118	hard chromed	2421-R13	13
			13.4-14.6	45	118	hard chromed	2421-R14	14
			14.4-15.6	45	118	hard chromed	2421-R15	15
			15.4-16.6	45	118	hard chromed	2421-R16	16
			16.4-17.6	45	118	hard chromed	2421-R17	17
			17.4-18.6	45	118	hard chromed	2421-R18	18
			18.4-19.6	45	118	hard chromed	2421-R19	19
			19.4-20.6	45	118	hard chromed	2421-R20	20

principle of measurement

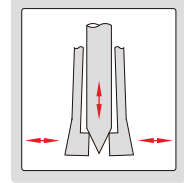

dial indicator is optional

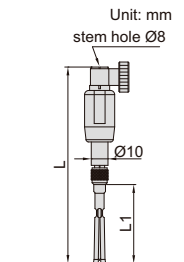
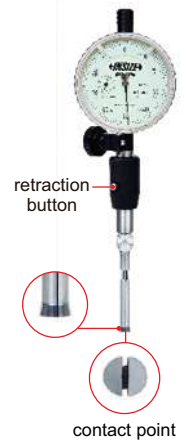

BORE GAGES FOR SMALL HOLES

INSIZE PLUS
MADE IN GERMANY

- Applicable for 0.01mm or 0.001mm graduation dial indicators
- Carbide contact point and anvil
- Optional accessory: dial indicator or dial comparator, setting ring (code 6312)

dial comparator is optional



2425-6

Code	Range	Accuracy (without dial comparator)	Repeatability (without dial comparator)	(mm)				
				L1	L2	ØR	ØD	h
2425-6	4.5-6mm	2µm	0.5µm	80	147	4	4	2
2425-8	6-8mm	2µm	0.5µm	100	165	5	5.2	2.6
2425-12	8-12mm	2µm	0.5µm	100	166	5	6.5	3.25
2425-20	12-20mm	2µm	0.5µm	110	204	8	9	4.5

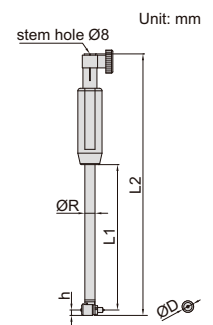

BORE GAGES

INSIZE PLUS
MADE IN GERMANY

contact points



6

- Applicable for 0.01mm or 0.001mm graduation dial indicators
- Optional accessory:
 - Dial indicator or dial comparator
 - Setting ring (code 6312)
 - Long handle (code 7352)

dial comparator is optional



2422-150

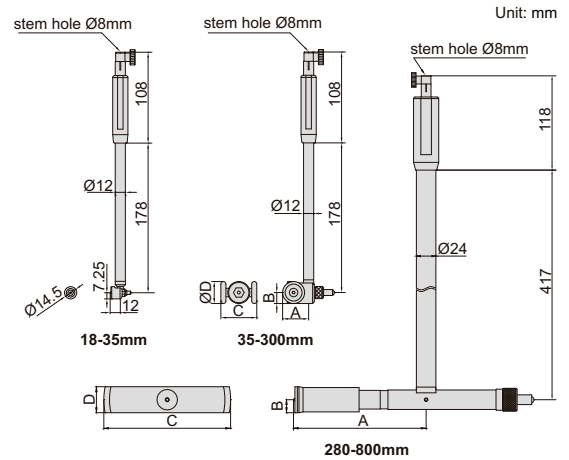

Code	Range	Accuracy (without dial comparator)	Repeatability (without dial comparator)
2422-35	18-35mm	4µm	2µm
2422-60	35-60mm	4µm	2µm
2422-150	50-150mm	4µm	2µm
2422-300	150-300mm	4µm	2µm
2422-510	280-510mm	3µm	1.5µm
2422-800	400-800mm	3µm	1.5µm

Range	A	B	C	D
35-60mm	19.5mm	10.5mm	28mm	21mm
50-150mm	30.8mm	13mm	42.5mm	26mm
150-300mm	30.8mm	13mm	76.5mm	26mm
280-510mm	164mm	16mm	156mm	32mm
400-800mm	305mm	18mm	300mm	36mm

BORE GAGE SET

INSIZE PLUS
MADE IN GERMANY



2423-S2

- Includes bore gages 18-50mm and 50-150mm
- Optional accessory:
 - 0.01mm or 0.001mm graduation dial indicator or dial comparator
 - Setting ring (code 6312)
 - Long handle (code 7352)

dial comparator is optional



18-50mm



50-150mm

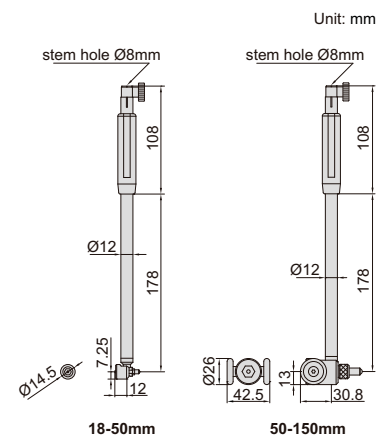

Code	Range	Accuracy (without dial comparator)	Repeatability (without dial comparator)
2423-S2	18-150mm	4µm	2µm

RELATIVE PRODUCT: INTERNAL GEAR TOOTH MICROMETER (CODE 3637, 3638)

- Tungsten carbide ball points, diameter accuracy 2µm
- Optional accessory:
 - Dial indicator or dial comparator
 - Ball points
 - Thread adaptor
 - Long handle (code 7352)

GEAR BORE GAGES

INSIZE PLUS
MADE IN GERMANY

dial comparator is optional



2428-55

ball points (optional)

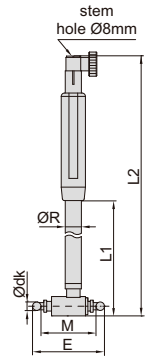

Code	Range (E)	Accuracy (without dial comparator)	Repeatability (without dial comparator)	ØR	L1	L2	Thread for ball points
2428-12	8-12mm	2µm	0.5µm	5	100	165	M1.6
2428-22	12-22mm	2µm	0.5µm	5	102	168	M1.6
2428-55	22-55mm	2µm	0.5µm	8	110	204	M2.5
2428-250	55-250mm	2µm	0.5µm	12	177	290	M4
2428-510	100-510mm	2µm	0.5µm	18	235	363	M4

Ball points (optional)

Ball point diameter Ødk	2428-12	2428-22	2428-55	2428-250	2428-510
	point thread M1.6	point thread M1.6	point thread M2.5	point thread M4	point thread M4
	point code	point code	point code	point code	point code
1mm	2428-A1	2428-E1	2428-B1	2428-C1	2428-C1
1.5mm	2428-A1D5	2428-E1D5	2428-B1D5	2428-C1D5	2428-C1D5
2mm	2428-A2	2428-E2	2428-B2	2428-C2	2428-C2
2.5mm	—	2428-E2D5	2428-B2D5	2428-C2D5	2428-C2D5
3mm	—	2428-E3	2428-B3	2428-C3	2428-C3
3.5mm	—	2428-E3D5	2428-B3D5	2428-C3D5	2428-C3D5
4mm	—	2428-E4	2428-B4	2428-C4	2428-C4
4.5mm	—	—	2428-B4D5	2428-C4D5	2428-C4D5
5mm	—	—	2428-B5	2428-C5	2428-C5
5.5mm	—	—	2428-B5D5	2428-C5D5	2428-C5D5
6mm	—	—	2428-B6	2428-C6	2428-C6
6.5mm	—	—	2428-B6D5	2428-C6D5	2428-C6D5
7mm	—	—	2428-B7	2428-C7	2428-C7
7.5mm	—	—	2428-B7D5	2428-C7D5	2428-C7D5
8mm	—	—	2428-B8	2428-C8	2428-C8
8.5mm	—	—	2428-B8D5	2428-C8D5	2428-C8D5
9mm	—	—	2428-B9	2428-C9	2428-C9
9.5mm	—	—	2428-B9D5	2428-C9D5	2428-C9D5
10mm	—	—	2428-B10	2428-C10	2428-C10

ball points (optional), in pair



extension rod for points (included)



method of measurement

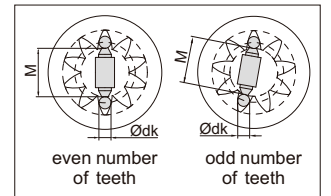
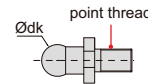

Thread adaptor (optional)

Code	Thread	Remark
2428-D1	M1.6/M2.5	For example, use 2428-E1 with 2428-D1 to replace 2428-B1
2428-D2	M2.5/M4	For example, use 2428-B1 with 2428-D2 to replace 2428-C1

- To measure diameter of shallow and blind holes
- Optional accessory:
 - 0.01mm or 0.001mm graduation dial indicators
 - Setting ring (code 6312)
 - Long handle (code 7352)



20-50mm

50-110mm

110-600mm

BORE GAGES FOR BLIND HOLES

INSIZE PLUS
MADE IN GERMANY

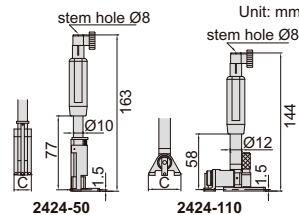

2424-50

2424-110

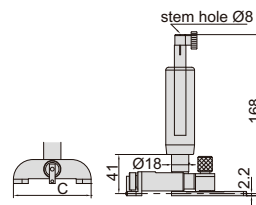

2424-300 and 2424-600

Code	Range	Accuracy (without dial indicator)	Repeatability (without dial indicator)	C
2424-50	20-50mm	4µm	1µm	18mm
2424-110	50-110mm	4µm	1µm	34mm
2424-300	110-300mm	4µm	1µm	81mm
2424-600	300-600mm	4µm	1µm	140mm



dial indicator is optional

2424-300

ROTARY BORE GAGE

INSIZE PLUS
MADE IN GERMANY

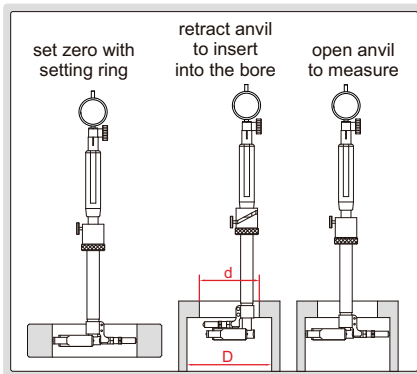

dial indicator
is optional



2921-150

rotary anvil

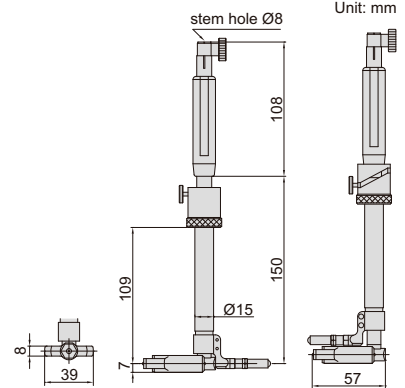

Unit: mm

- Rotary anvil, to measure bores with small opening
D: bore diameter to be measured,
d: minimum opening diameter (see right drawing)
d=57mm (D≤95mm)
d=D-38 (D>95mm)
- Optional accessory:
 - 0.01mm or 0.001mm graduation dial indicator or dial comparator
 - Setting ring (code 6312)

Code	Range	Accuracy (without dial indicator)	Repeatability* (without dial indicator)
2921-150	80-150mm	2µm	1µm

* Repeatability includes the error of rotary anvil

BORE GAGES FOR BARRIER INSIDE BORE

INSIZE PLUS
MADE IN GERMANY

MEASURE DIAMETER OF
BORES WITH BARRIER INSIDE

ATTENTION: NOT SUITABLE
FOR 0.001MM DIAL INDICATORS

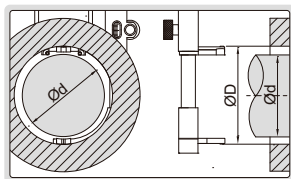

dial indicator
is optional



2432-105

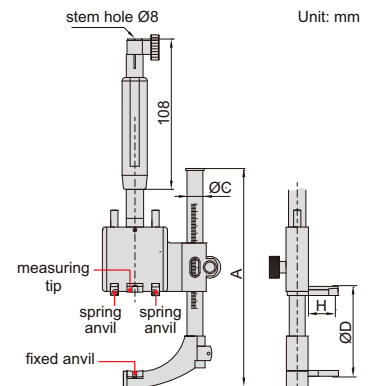

Unit: mm

- Measure diameter of bores with barrier inside
- Optional accessory:
 - 0.01mm graduation dial indicators
 - Setting ring (code 6312)

Code	Range ØD	Diameter of barrier Ød	Travel of measuring tip	Measuring depth H	Accuracy (without dial indicator)	Measuring force	A	ØC
2432-70	25-70mm	<D-6 (less than 45mm) *	2.5	12	0.01	1.5N	115	10
2432-105	35-105mm	<D-11 (less than 70mm) *	3.0	18	0.01	2.5N	150	11
2432-210	100-210mm	<D-20 (less than 130mm) *	3.5	30	0.015	2.5N	233	15
2432-280	100-280mm	<D-20 (less than 130mm) *	3.5	30	0.015	2.5N	303	15
2432-500	200-500mm	<D-20 (less than 240mm) *	3.5	30	0.02	2.5N	622	30

* For example, range of 2432-70 is 25-70mm, diameter of barrier is <D-6 (less than 45mm)
When measuring size is 40mm, D-6=34mm, so the maximum diameter of barrier is 34mm.
When measuring size is 60mm, D-6=54mm, however it should be less than 45mm, so the maximum diameter of barrier is 45mm.



INTERNAL GROOVE BORE GAGES

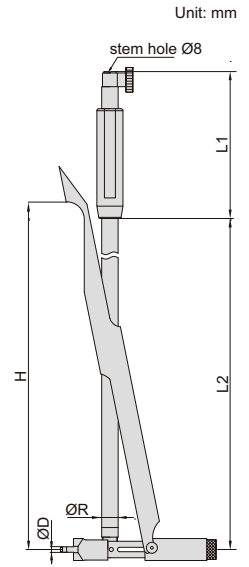
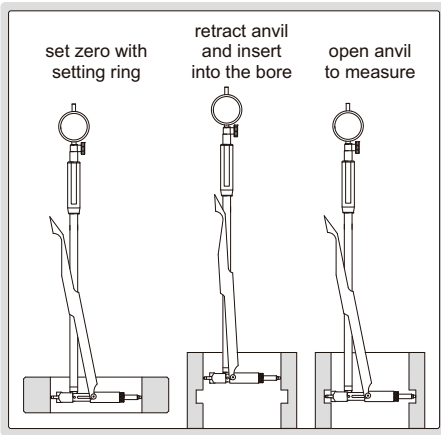

- Measure diameter of internal grooves (width of groove > 3mm)
- Anvil is needed
- Optional accessory:
 - 0.01mm or 0.001mm graduation dial indicators
 - Setting ring (code 6312)

Code	Range	Retraction of anvil	Measuring depth H	Accuracy (without dial indicator)	Repeatability (without dial indicator)	ØR	ØD	L1	L2
2433-120 *	60-120mm	8.5	120	2µm	1µm	10	3	85	150
2433-180 *	120-180mm	23	230	2µm	1µm	12	4	108	285
2433-300 *	180-300mm	30	280	2µm	1µm	18	4	120	245

* Supplied with manufacturer inspection certificate traceable to NIST USA

ANVIL (OPTIONAL)

Code	Remark
2433-P□□□□	We design and make anvils according to the grooves to be measured. *

* Note: please provide the dimension of grooves to be measured.

- To assist deep-hole measurement
- Can be used for bore gages 2422, 2423 and 2424

LONG HANDLES

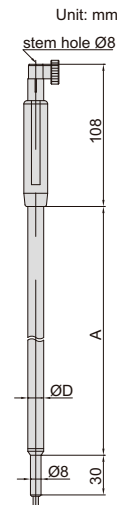

method of use

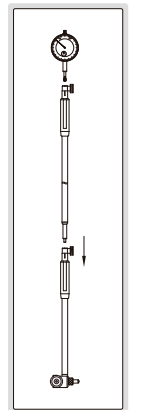

Code	Applicable bore gages	A	ØD
7352-500	above 35mm	438	12
7352-1000		938	12

BORE GAGES

ATTENTION: NOT SUITABLE FOR 0.001MM DIAL INDICATORS

DATA OUTPUT

6

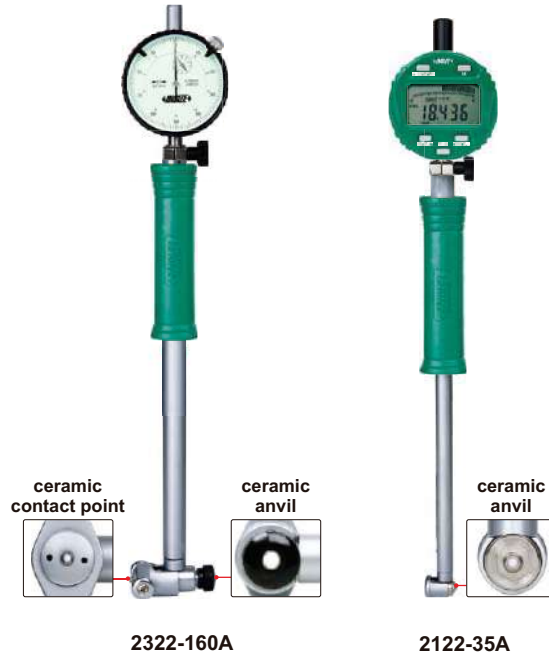
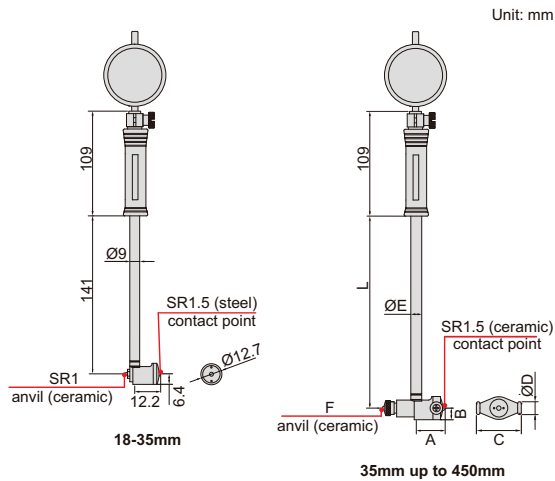

- Optional accessory: setting ring (code **6312**), long handle (code **7351**)

Range	A	B	C	ØD	ØE	F	L
35-60mm	22	9	27	13	12.8	SR2	141
50-100mm	26	9	35	13	12.8	SR2	141
50-160mm	26	9	35	13	12.8	SR2	141
100-160mm	26	9	35	13	12.8	SR2	141
160-250mm	56.5	13	74.5	15	12.8	SR2	241
250-450mm	86.5	15	101.5	15	14.5	SR2.5	241



With dial indicator

Code	Range	Indicator	Accuracy	Repeatability
2322-35A	18-35mm	dial indicator, range 10mm, graduation 0.01mm (code 2308-10FA)	±0.015mm	0.003mm
2322-60A	35-60mm		±0.018mm	0.003mm
2322-100A	50-100mm		±0.018mm	0.003mm
2322-160A	50-160mm		±0.018mm	0.003mm
2322-161A	100-160mm		±0.018mm	0.003mm
2322-250A	160-250mm		±0.018mm	0.003mm
2322-450A	250-450mm		±0.018mm	0.003mm

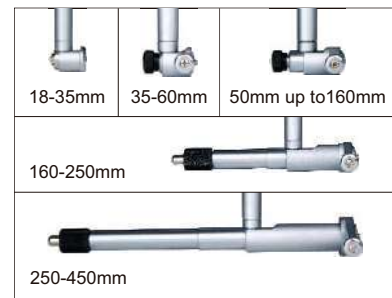

With digital indicator

Code	Range	Indicator	Accuracy	Repeatability
2122-35A	18-35mm	digital indicator, range 12.7mm/0.5", resolution 0.002mm/0.0001" (code 2108-10F)	±0.015mm	0.003mm
2122-60A	35-60mm		±0.018mm	0.003mm
2122-100A	50-100mm		±0.018mm	0.003mm
2122-160A	50-160mm		±0.018mm	0.003mm
2122-161A	100-160mm		±0.018mm	0.003mm
2122-250A	160-250mm		±0.018mm	0.003mm
2122-450A	250-450mm	±0.018mm	0.003mm	

with digital indicator

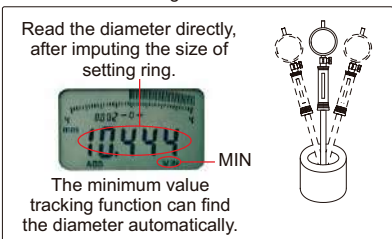

ATTENTION: NOT SUITABLE FOR 0.001MM DIAL INDICATORS

BORE GAGES FOR SMALL HOLES

with digital indicator

Read the diameter directly, after inputting the size of setting ring.

MIN

The minimum value tracking function can find the diameter automatically.

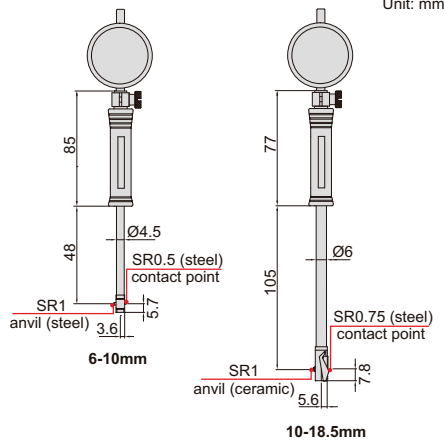

Optional accessory: setting ring (code 6312)

With dial indicator

Code	Range	Indicator	Accuracy	Repeatability
2852-10	6-10mm	dial indicator, range 3mm, graduation 0.01mm (code 2311-3F)	±0.012mm	0.003mm
2852-18	10-18.5mm		±0.012mm	0.003mm

With digital indicator

Code	Range	Indicator	Accuracy	Repeatability
2152-10	6-10mm	digital indicator, range 12.7mm/0.5", resolution 0.002mm/0.0001" (code 2108-10F)	±0.012mm	0.003mm
2152-18	10-18.5mm		±0.012mm	0.003mm

ATTENTION: NOT SUITABLE FOR 0.001MM DIAL INDICATORS

BORE GAGES

with digital indicator

Read the diameter directly, after inputting the size of setting ring.

MIN

The minimum value tracking function can find the diameter automatically.

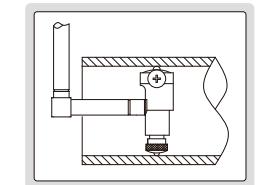
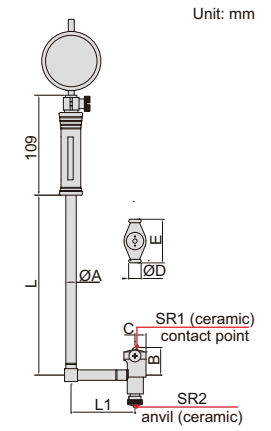

Optional accessory: setting ring (code 6312), long handle (code 7351)

With dial indicator

Code	Range	Indicator	Accuracy	Repeatability
2827-60A	35-60mm	dial indicator code 2308-10FA, range 10mm, graduation 0.01mm	±0.018mm	0.003mm
2827-160A	50-160mm		±0.018mm	0.003mm
2827-250A	160-250mm		±0.018mm	0.003mm
2827-450A	250-450mm		±0.018mm	0.003mm

With digital indicator

Code	Range	Indicator	Accuracy	Repeatability
2127-60A	35-60mm	digital indicator code 2108-10F, range 12.7mm/0.5", resolution 0.002mm/0.0001"	±0.018mm	0.003mm
2127-160A	50-160mm		±0.018mm	0.003mm
2127-250A	160-250mm		±0.018mm	0.003mm
2127-450A	250-450mm		±0.018mm	0.003mm

Range	ØA	B	C	ØD	E	L	L1
35-60mm	12.8	22	9	13	27	141	75
50-160mm	12.8	28.5	9.2	13	35	141	76.2
160-250mm	14.5	62.0	12.7	15	74.5	391	100
250-450mm	14.5	91.5	15.0	15	101.5	391	100

(mm)

BORE GAGES

ATTENTION: NOT SUITABLE FOR 0.001MM DIAL INDICATORS

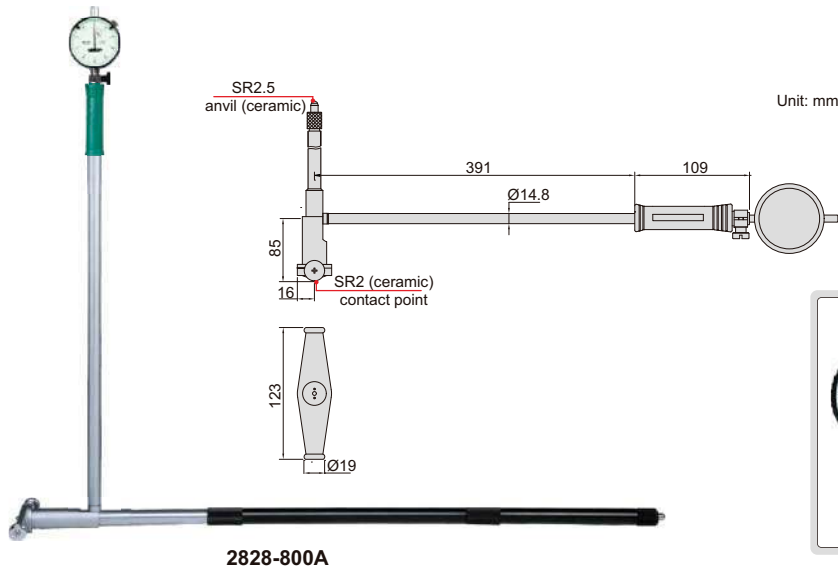

6

Code	Range	Indicator	Accuracy	Repeatability
2828-800A	400-800mm	dial indicator code 2308-10FA, range 10mm, graduation 0.01mm	±0.025mm	0.003mm
2128-800A	400-800mm	digital indicator code 2108-10F, range 12.7mm/0.5", graduation 0.002mm/0.0001"	±0.025mm	0.003mm

BORE GAGE SETS

ATTENTION: NOT SUITABLE FOR 0.001MM DIAL INDICATORS

packaging (code 2824-S3)



- Optional accessory: setting ring (code 6312), long handle (code 7351)



with digital indicator

Read the diameter directly, after inputting the size of setting ring.



The minimum value tracking function can find the diameter automatically.

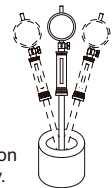

With dial indicator

Code	Range	Indicator	Bore gages included	Accuracy	Repeatability
2824-S160	35-160mm	dial indicator, code 2308-10FA, range 10mm, graduation 0.01mm	① 35-50mm (dial indicator and handle are optional) ② 50-160mm	35-50mm ±0.018mm 50-160mm ±0.018mm	0.003mm
2824-S3	18-160mm	dial indicator, code 2308-10FA, range 10mm, graduation 0.01mm	① 18-35mm ② 35-60mm (dial indicator is optional) ③ 50-160mm (dial indicator is optional)	18-35mm ±0.015mm 35-60mm ±0.018mm 50-160mm ±0.018mm	0.003mm

With digital indicator

Code	Range	Indicator	Bore gages included	Accuracy	Repeatability
2724-S160	35-160mm	digital indicator, code 2108-10F range 12.7mm/0.5", resolution 0.002mm/0.0001"	① 35-50mm (digital indicator and handle are not included) ② 50-160mm	35-50mm ±0.018mm 50-160mm ±0.018mm	0.003mm
2724-S3	18-160mm	digital indicator, code 2108-10F range 12.7mm/0.5", resolution 0.002mm/0.0001"	① 18-35mm ② 35-60mm (digital indicator is optional) ③ 50-160mm (digital indicator is optional)	18-35mm ±0.015mm 35-60mm ±0.018mm 50-160mm ±0.018mm	0.003mm

LONG HANDLES

- To assist deep-hole measurement
- Can be used for bore gages 2122, 2127, 2322, 2724, 2824 and 2827

Code	Applicable bore gages	A	ØD	Type
7351-EX11	35-60mm,	475	13	B
7351-EX12	50-100mm,	980	13	
7351-EX13	50-160mm,	1480	14.5	A
7351-EX14	100-160mm	1980	14.5	
7351-EX21	160-250mm, 250-450mm	480	14.5	B
7351-EX22		980	14.5	B
7351-EX23		1480	14.5	A
7351-EX24		1980	14.5	A

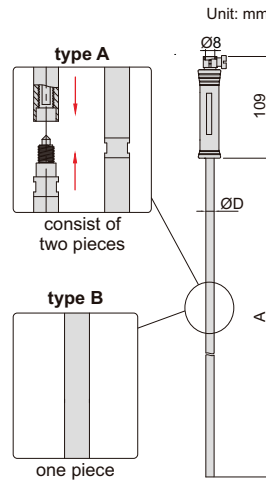

method of use (replace the original handle with long handle)

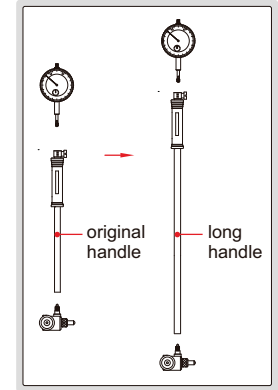

ANVILS FOR BORE GAGES

- For bore gages 2852, 2152, 2322, 2122, 2127, 2724, 2824 and 2827



7350-160

Code	Applicable bore gages	Material of measuring face	Quantity per set	Measuring range of anvil (mm)
7350-10	6-10mm	steel	9 pcs	6, 6.5, 7, 7.5, 8, 8.5, 9, 9.5, 10
7350-18	10-18.5mm	ceramic	9 pcs	10, 11, 12, 13, 14, 15, 16, 17, 18
7350-35	18-35mm	ceramic	9 pcs	18, 20, 22, 24, 26, 28, 30, 32, 34
7350-60	35-60mm	ceramic	6 pcs	35, 40, 45, 50, 55, 60
7350-100	50-100mm	ceramic	11 pcs	50, 55, 60, 65, 70, 75, 80, 85, 90, 95, 100
7350-160	50-160mm	ceramic	12 pcs	50, 55, 60, 65, 70, 75, 80, 85, 90, 95, 100, 105
7350-161	100-160mm	ceramic	12 pcs	50, 55, 60, 65, 70, 75, 80, 85, 90, 95, 100, 105
7350-250	160-250mm	ceramic	5 pcs	160, 170, 180, 190, 200
7350-450	250-450mm	ceramic	5 pcs	250, 260, 270, 280, 290

BORE GAGE SETTERS

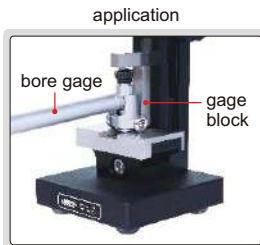

- Vertical and horizontal use
- To be used with gage blocks

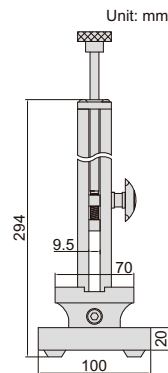

7353-160

horizontal use



gage blocks for 7353-160



Gage block set for 7353-160

Blocks per set	Size (mm)	Step (mm)	Quantity	Remark
33	1.005	0.01	1 pc	grade 2 (ISO3650)
	1.01-1.09		9 pcs	
	1.1-1.9		9 pcs	
	1-9	1	9 pcs	
	10-30	10	3 pcs	
	50		1 pc	
	100		1 pc	

Code	Range	Repeatability	Remark
7353-160	0-160mm	1.2µm	with gage block set
7353-160W	0-160mm	1.2µm	without gage block set

BORE GAGE SETTER



- Used together with gage blocks to set bore gages

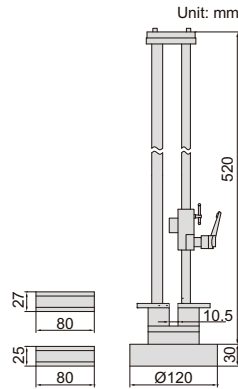

2395-400

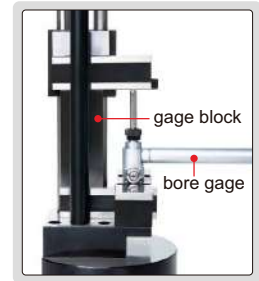

6

Code	Setting range
2395-400	18-400mm

INTERNAL CHAMFER GAGES

INSIZE PLUS
MADE IN GERMANY

measure end diameter of chamfer or taper holes

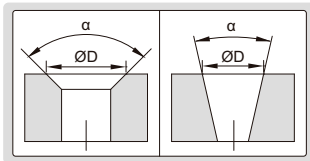

2941-20

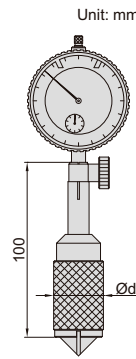

INSPECTION CERTIFICATE
TRACEABLE TO DKD

measurement principle

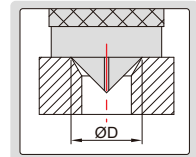

5mm setting ring for 2941-20 and 2941-203



- Measure end diameter of chamfer or taper holes
- With limit pointers
- 2941-20 and 2941-203 are supplied with 5mm setting ring

Code	Range ØD	Applicable angle α	Graduation	Accuracy	Ød
2941-20*	0.5-20.1mm	0-90°	0.01mm	±0.02mm	28.3mm
2941-40*	20-40mm	0-90°	0.01mm	±0.02mm	50mm
2941-203*	0.5-20.1mm	90-127°	0.02mm	±0.04mm	28.3mm
2941-403*	20-40mm	90-127°	0.02mm	±0.04mm	50mm

*Supplied with manufacturer inspection certificate traceable to DKD Germany

DIGITAL INTERNAL CHAMFER GAGES

INSIZE PLUS
MADE IN GERMANY



2942-20

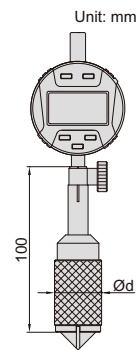

DATA OUTPUT

INSPECTION CERTIFICATE
TRACEABLE TO DKD

measurement principle

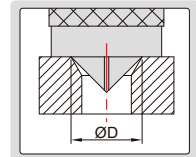

5mm setting ring for 2942-20 and 2942-203



- Measure end diameter of chamfer or taper holes
- 2942-20 and 2942-203 are supplied with 5mm setting ring
- Resolution: 0.01mm/0.0005"
- Optional accessory: data output cable (code 7315-, 7302-, 7305-)

Code	Range ØD	Applicable angle α	Accuracy	Ød
2942-20*	0.5-20.1mm	0-90°	±0.02mm	28.3mm
2942-40*	20-40mm	0-90°	±0.02mm	50mm
2942-203*	0.5-20.1mm	90-127°	±0.04mm	28.3mm
2942-403*	20-40mm	90-127°	±0.04mm	50mm

*Supplied with manufacturer inspection certificate traceable to DKD Germany

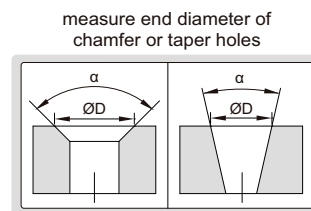

SMALL HOLE GAGE SET

- 4 gages per set
- For small holes, slots and grooves, etc.
- Satin chrome finish

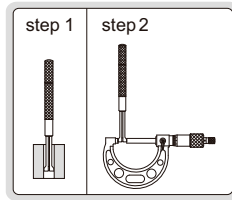

4208-1

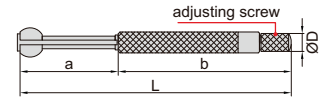

Range	L	a	b	ØD
3-5mm	76	24	52	5
5-7.5mm	79	27	52	5
7.5-10mm	88	30	58	6
10-13mm	91	34	58	6

Code	Total range	Gages included
4208-1	3-13mm	3-5mm, 5-7.5mm, 7.5-10mm, 10-13mm

TELESCOPING GAGE SET

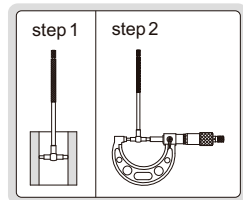

4206-1

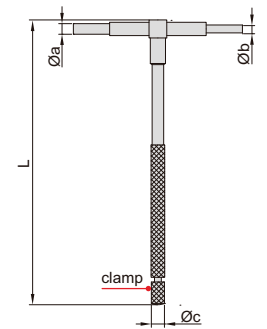

- 6 gages per set
- For quick measurement of inside diameter of holes and width of slots
- Satin chrome finish

Range	L	Øa	Øb	Øc
8-12.7mm	115	3.9	2.9	6.2
12.7-19mm	115	5.3	3.8	6.2
19-32mm	115	5.3	3.8	6.2
32-54mm	137	7.6	6.1	7.2
54-90mm	137	7.6	6.1	7.2
90-150mm	137	7.6	6.1	7.2

Code	Total range	Gages included
4206-1	8-150mm	8-12.7mm, 12.7-19mm, 19-32mm, 32-54mm, 54-90mm, 90-150mm

LONG HANDLE TELESCOPING GAGES

- For quick measurement of inside diameter of deep holes and width of slots
- Satin chrome finish



4209-6

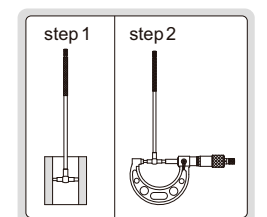
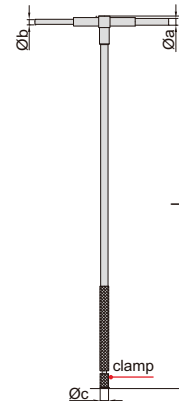

Code	Range	L	Øa	Øb	Øc
4209-1	8-12.7mm	300	3.9	2.9	6.2
4209-2	12.7-19mm	300	5.3	3.8	6.2
4209-3	19-32mm	300	5.3	3.8	6.2
4209-4	32-54mm	300	7.6	6.1	7.2
4209-5	54-90mm	300	7.6	6.1	7.2
4209-6	90-150mm	300	7.6	6.1	7.2

DIGITAL RADIUS GAGE

ATTENTION: NO DATA OUTPUT

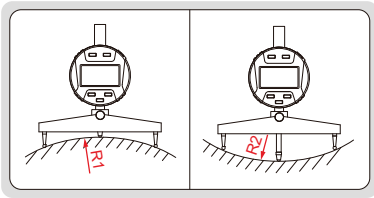

2183

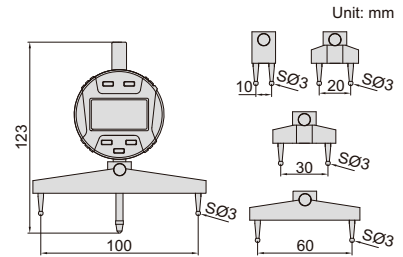

- Resolution: 0.005mm/0.0002"
- Buttons: on/off, hold, mm/inch, s (select jaws), zero
- Measure radius of internal or external arcs
- Display can be rotated by 320°
- Supplied with 5 jaws for different sizes of arc
- Battery CR2032, automatic power off

Code	Range of external radius (R1)	Range of internal radius (R2)	Accuracy (mm)
2183	5-910mm/0.2-35.83"	7-910mm/0.3-35.83"	±0.01R*

*R is the radius to be measured. For example, radius is 100mm, the accuracy is ±0.01x100=±1mm

6

LARGE DIAMETER GAGE CODE ISQ-RA600

INSIZE PLUS
MADE IN ITALY

DATA OUTPUT



software CD (included)

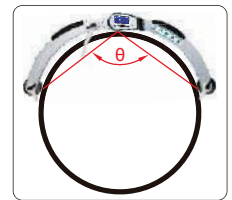

- To measure large external or internal diameters
- Automatic judgment and display external or internal diameter
- Backlight LCD display, can rotate 180° for easy reading
- Memory of 12 readings and average calculation
- With minimum and maximum measurement mode
- Angle can be displayed



external diameter measurement



internal diameter measurement

SPECIFICATION

Range	external	Ø500~6000mm/19.69~236.22"
	internal	Ø1100~6000mm/43.31~236.22"
Resolution		0.01mm/0.001"
Accuracy		±(0.01+D ² /30)mm (D is the diameter to be measured, in meter)
Power supply		rechargeable battery (for 8 hours working)
Weight		3.8kg

STANDARD DELIVERY

Main unit	1 pc
AC/DC adapter	1 pc
USB cable and software	1 pc

Accuracy sample by diameters

Diameter	Accuracy
500mm	±0.018mm
1000mm	±0.043mm
1500mm	±0.085mm
2000mm	±0.143mm
2500mm	±0.218mm
3000mm	±0.310mm
4000mm	±0.543mm
5000mm	±0.843mm
6000mm	±1.210mm



software (included), data output, save and print

MEASURE INTERNAL DIAMETER OF FLEXIBLE MATERIALS (FOR EXAMPLE, BELT)

- Graduation: 0.1mm
- Accuracy: 0.2mm



Code	Range ØD	Ød	ØA	Measuring depth
2430-24	14-24mm	13.5	13	15-60
2430-40	22-40mm	21.5	21	15-60
2430-60	35-60mm	34.5	30.5	15-96
2430-100	55-100mm	54.5	30.5	15-106
2430-180	95-180mm	94.5	30.5	15-106
2430-255	170-255mm	169.5	30.5	15-106
2430-330	245-330mm	244.5	30.5	15-106



TAPE BORE GAGES

INSIZE PLUS
MADE IN GERMANY

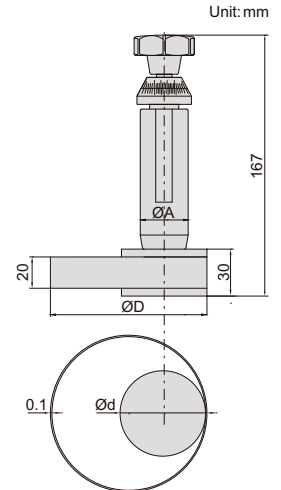

- Measure internal diameter and circumference of tubes, belts, etc.
- Laser engraved scale
- Made of stainless steel
- Optional accessory: holder (code 7125-HOLDER)



INTERNAL CIRCUMFERENCE TAPES

INSIZE PLUS
MADE IN GERMANY

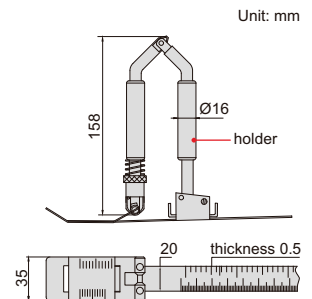

Code	Circumference range	Diameter range	Graduation	Accuracy	
				Circumference	Diameter
7125-1550	720-1550mm	Ø230-490mm	0.1mm	±0.35mm	±0.20mm
7125-2200	940-2200mm	Ø300-700mm	0.1mm	±0.35mm	±0.20mm
7125-3460	2190-3460mm	Ø700-1100mm	0.1mm	±0.45mm	±0.23mm
7125-4720	3450-4720mm	Ø1100-1500mm	0.1mm	±0.45mm	±0.23mm
7125-5980	4710-5980mm	Ø1500-1900mm	0.1mm	±0.50mm	±0.25mm
7125-7230	5970-7230mm	Ø1900-2300mm	0.1mm	±0.55mm	±0.27mm
7125-8500	7220-8500mm	Ø2300-2700mm	0.1mm	±0.55mm	±0.27mm

HOLDER (OPTIONAL)

Code
7125-HOLDER

- Graduation: 0.1mm
- Measure diameter and circumference of pipes, trees, tires, etc.
- Laser engraved scale
- Made of stainless steel



7114-950

Code	Circumference range	Diameter range	Accuracy	
			Circumference	Diameter
7114-950	150-950mm	Ø50-300mm	±3mm	±1mm
7114-2200	940-2200mm	Ø300-700mm	±3mm	±1mm
7114-3460	2190-3460mm	Ø700-1100mm	±3mm	±1mm

CIRCUMFERENCE TAPES

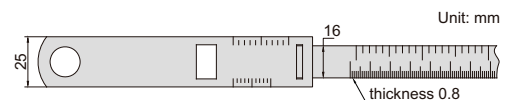
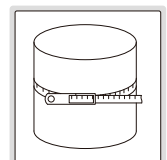

CIRCUMFERENCE TAPES

INSIZE PLUS
MADE IN GERMANY

CAN SUPPLY TAPE WIDTH
6MM, 35MM, 60MM

- Graduation: 0.1mm
- Measure diameter and circumference of pipes, trees, tires, etc.
- Laser engraved scale
- Made of stainless steel

Code	Circumference range	Diameter range	Accuracy	
			Circumference	Diameter
7115-950*	150-950mm	Ø50-300mm	±0.60mm	±0.20mm
7115-2200	940-2200mm	Ø300-700mm	±0.60mm	±0.20mm
7115-3460	2190-3460mm	Ø700-1100mm	±0.60mm	±0.20mm
7115-4720	3450-4720mm	Ø1100-1500mm	±0.90mm	±0.30mm
7115-5980	4710-5980mm	Ø1500-1900mm	±0.90mm	±0.30mm
7115-7230	5970-7230mm	Ø1900-2300mm	±1.05mm	±0.35mm
7115-8500	7220-8500mm	Ø2300-2700mm	±1.20mm	±0.40mm
7115-9760	8490-9760mm	Ø2700-3100mm	±1.35mm	±0.45mm
7115-11010	9730-11010mm	Ø3100-3500mm	±1.50mm	±0.50mm

*When diameter range is Ø50-100mm, the accuracy of circumference is ±0.90mm, diameter is ±0.30mm



7115-3460

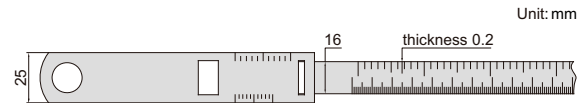

Unit: mm

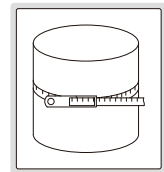

CIRCUMFERENCE TAPES

INSIZE PLUS
MADE IN GERMANY

- Measure diameter of cables, thin plastic pipes, etc., which may deform
- Laser engraved scale
- Made of stainless steel

Code	Diameter range	Graduation	Accuracy
7116-115	Ø20-115mm	0.05mm	±0.10mm
7116-230	Ø100-230mm	0.05mm	±0.10mm
7116-330	Ø200-330mm	0.05mm	±0.15mm
7116-620	Ø300-620mm	0.05mm	±0.20mm



7116-115

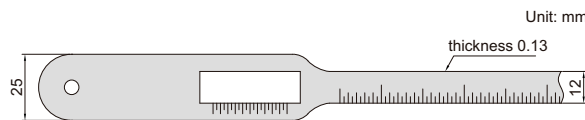

Unit: mm

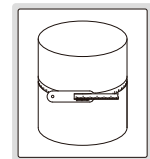

HIGH PRECISION DIGITAL INDICATORS

ABSOLUTE ENCODER, THE ORIGINAL
DATA REMAINS AFTER POWER OFF

Ø28MM STEM SUITABLE FOR
REINFORCED CLAMPING

LINEAR BALL BEARINGS
FOR TEN MILLION TIMES USE

DATA
OUTPUT

ATTENTION: RECHARGEABLE BATTERY,
FOR 24 HOURS CONTINUOUS WORKING

- Linear ball bearings for ten million times use
- Ø28mm stem suitable for reinforced clamping
- Absolutely encoder, the original data remains after power off
- Adjustable resolution: 0.0002mm/0.00001"
0.001mm/0.00001"
0.01mm/0.0001"
- The display flips over when the spindle faces up
- Reading in digital and analog
- Data output
- Button function: data output, tolerance, data preset, data hold, direction change, max./min./TIR, power off time, on/off, mm/inch, analog pointer graduation adjustment, adjust resolution
- Power: rechargeable battery, for 24 hours continuous working
- Ruby probe

Code	Range	Accuracy	Hysteresis	Remark	Wireless
2140-6	0-6mm/0-0.24"	1.6µm	0.8µm	flat back	no
2140-6WL	0-6mm/0-0.24"	1.6µm	0.8µm	flat back	built-in wireless



2140-6

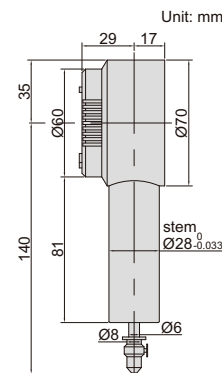

Unit: mm

warning when
over tolerance

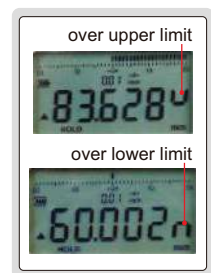

analog pointer

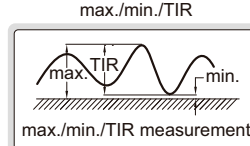
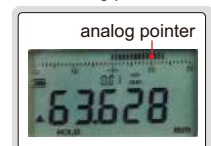

max./min./TIR

LINEAR BALL BEARINGS
FOR TEN MILLION TIMES USE

ABSOLUTE ENCODER, THE ORIGINAL
DATA REMAINS AFTER POWER OFF

HIGH PRECISION DIGITAL INDICATORS

DATA
OUTPUT

ATTENTION: RECHARGEABLE BATTERY,
FOR 24 HOURS CONTINUOUS WORKING

**INSPECTION
CERTIFICATE**
TRACEABLE TO NIST

warning when
over tolerance

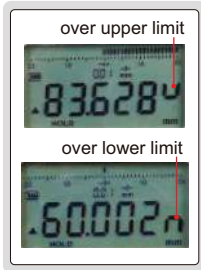

analog pointer

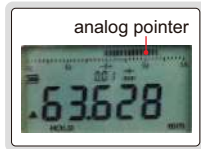

2133-10



2133-25



2133-501

- Linear ball bearings for ten million times use
- Absolutely encoder, the original data remains after power off
- The display flips over when the spindle faces up
- Reading in digital and analog
- Data output
- Button function: data output, tolerance, data preset, datahold, measuring direction change, max./min./TIR, power off time, on/off, mm/inch, analog pointer graduation adjustment, adjust resolution
- Power: rechargeable battery, for 24 hours continuous working

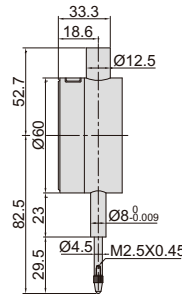

2133-10
2133-101

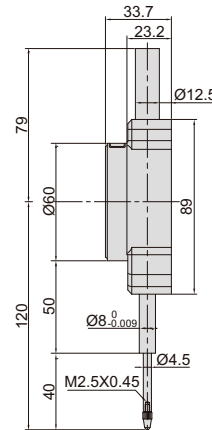

2133-25
2133-251

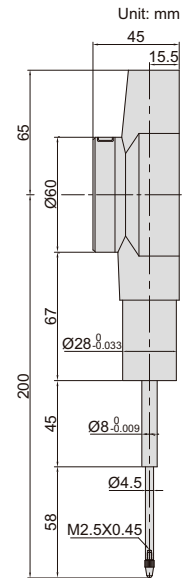

2133-501

Adjustable resolution: 0.0005mm/0.00001"
0.001mm/0.00001"
0.01mm/0.0001"

Code	Range	Accuracy	Hysteresis	Remark
2133-10*	12.7mm/0.5"	3µm	1.5µm	flat back
2133-25*	25.4mm/1"	3µm	1.5µm	flat back

Adjustable resolution: 0.0002mm/0.00001"
0.001mm/0.00001"
0.01mm/0.0001"

Code	Range	Accuracy	Hysteresis	Remark
2133-101*	12.7mm/0.5"	1.5µm	1µm	flat back
2133-251*	25.4mm/1"	1.8µm	1µm	flat back
2133-501*	50.8mm/2"	3µm	1.5µm	flat back

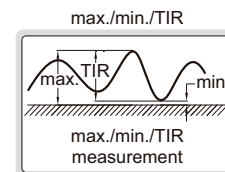

spindle lift knob is included



*Supplied with manufacturer inspection certificate traceable to NIST USA

WIRELESS HIGH PRECISION DIGITAL INDICATORS

LINEAR BALL BEARINGS FOR TEN MILLION TIMES USE

ABSOLUTE ENCODER, THE ORIGINAL DATA REMAINS AFTER POWER OFF

DATA OUTPUT

ATTENTION: RECHARGEABLE BATTERY, FOR 24 HOURS CONTINUOUS WORKING

INSPECTION CERTIFICATE
TRACEABLE TO NIST

7

warning when over tolerance

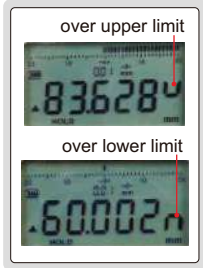

analog pointer

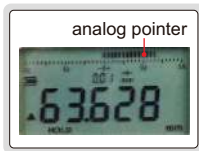

2134-10



2134-25



2134-501

- Built-in wireless transmission, ZigBee single
- Linear ball bearings for ten million times use
- Absolutely encoder, the original data remains after power off
- The display flips over when the spindle faces up
- Reading in digital and analog
- Data output
- Button function: data output, tolerance, data preset, data hold, measuring direction change, max./min./TIR, power off time, on/off, mm/inch, analog pointer graduation adjustment, adjust resolution
- Power: rechargeable battery, for 24 hours continuous working

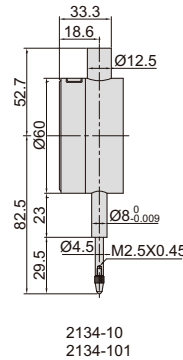

2134-10
2134-101

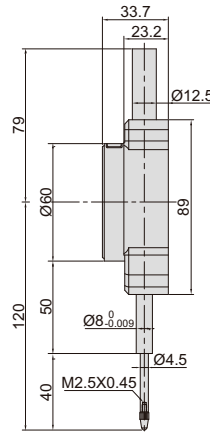

2134-25
2134-251

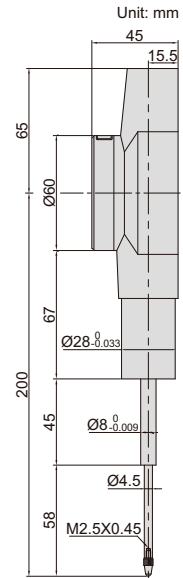

2134-501

Adjustable resolution: 0.0005mm/0.00001"
0.001mm/0.00001"
0.01mm/0.0001"

Code	Range	Accuracy	Hysteresis	Remark
2134-10*	12.7mm/0.5"	3µm	1.5µm	flat back
2134-25*	25.4mm/1"	3µm	1.5µm	flat back

Adjustable resolution: 0.0002mm/0.00001"
0.001mm/0.00001"
0.01mm/0.0001"

Code	Range	Accuracy	Hysteresis	Remark
2134-101*	12.7mm/0.5"	1.5µm	1µm	flat back
2134-251*	25.4mm/1"	1.8µm	1µm	flat back
2134-501*	50.8mm/2"	3µm	1.5µm	flat back

*Supplied with manufacturer inspection certificate traceable to NIST USA

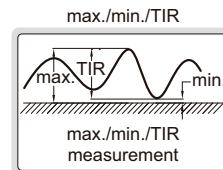

spindle lift knob is included



INSPECTION CERTIFICATE
TRACEABLE TO NIST

DATA OUTPUT

spindle lift knob is included

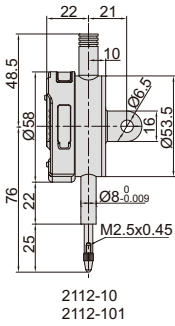

2112-10

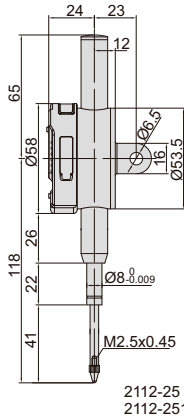

2112-251

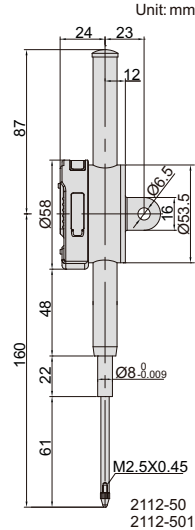

2112-501

- Button function: on/off, inch/mm, zero
- CR2032 battery, automatic power off
- Data output
- Optional accessory: data output cable (code **7315-**, **7302-**, **7305-**), backs (page 129~130), contact points (page 126~128)

Resolution 0.001mm/0.00005"

Code	Range	Accuracy	Hysteresis	Remark
2112-101F*	12.7mm/0.5"	5µm	2µm	flat back
2112-251F*	25.4mm/1"	5µm	3µm	flat back
2112-501F*	50.8mm/2"	6µm	3µm	flat back
2112-101*	12.7mm/0.5"	5µm	2µm	lug back
2112-251*	25.4mm/1"	5µm	3µm	lug back
2112-501*	50.8mm/2"	6µm	3µm	lug back

Resolution 0.01mm/0.0005"

Code	Range	Accuracy	Hysteresis	Remark
2112-10F*	12.7mm/0.5"	20µm	10µm	flat back
2112-25F*	25.4mm/1"	20µm	10µm	flat back
2112-50F*	50.8mm/2"	30µm	10µm	flat back
2112-10*	12.7mm/0.5"	20µm	10µm	lug back
2112-25*	25.4mm/1"	20µm	10µm	lug back
2112-50*	50.8mm/2"	30µm	10µm	lug back

*Supplied with manufacturer inspection certificate traceable to NIST USA

INSPECTION CERTIFICATE
TRACEABLE TO NIST

DATA OUTPUT

spindle lift knob is included

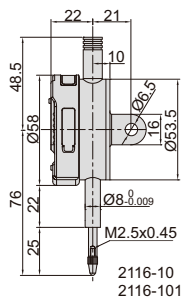

2116-10

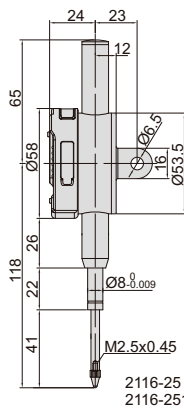

2116-251

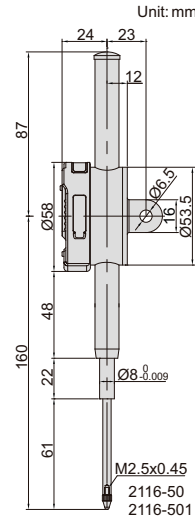

2116-501

- Button function: on/off, +/-, zero
- CR2032 battery, automatic power off, data output
- Optional accessory: data output cable (code **7315-**, **7302-**, **7305-**), backs (page 129~130), contact points (page 126~128)

Resolution 0.001mm

Code	Range	Accuracy	Hysteresis	Remark
2116-101F*	12.7mm	5µm	2µm	flat back
2116-251F*	25.4mm	5µm	3µm	flat back
2116-501F*	50.8mm	6µm	3µm	flat back
2116-101*	12.7mm	5µm	2µm	lug back
2116-251*	25.4mm	5µm	3µm	lug back
2116-501*	50.8mm	6µm	3µm	lug back

Resolution 0.01mm

Code	Range	Accuracy	Hysteresis	Remark
2116-10F*	12.7mm	20µm	10µm	flat back
2116-25F*	25.4mm	20µm	10µm	flat back
2116-50F*	50.8mm	30µm	10µm	flat back
2116-10*	12.7mm	20µm	10µm	lug back
2116-25*	25.4mm	20µm	10µm	lug back
2116-50*	50.8mm	30µm	10µm	lug back

*Supplied with manufacturer inspection certificate traceable to NIST USA

DIGITAL INDICATORS (ADVANCED TYPE)

DATA
OUTPUT

INSPECTION
CERTIFICATE
TRACEABLE TO NIST

7



2103-10



2104-25



2103-50

- Reading in digital and analog
- Display can be rotated by 320°
- Button function: tolerance Go and No-Go display, data preset, measuring direction change, max./min./TIR measurement, inch/metric conversion, absolute/incremental measurement
- Keep preset data and tolerance data in memory after restart
- CR2032 battery, automatic power off
- Data output
- Optional accessory: data output cable (code 7315-, 7302-, 7305-), backs (page 129~130), contact points (page 126~128)

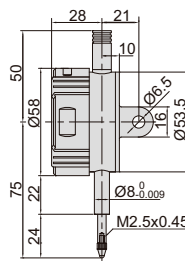

2103-10
2104-10

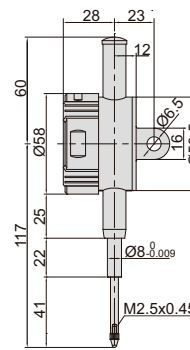

2103-25
2104-25

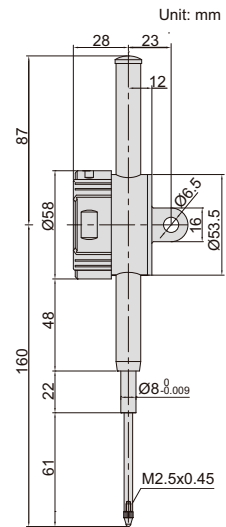

2103-50
2104-50

Unit: mm

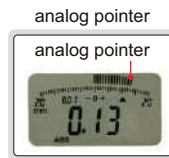
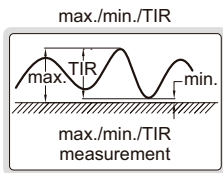

Resolution 0.001mm/0.00005"

Code	Range	Accuracy	Hysteresis	Remark
2103-10F*	12.7mm/0.5"	5µm	2µm	flat back
2103-25F*	25.4mm/1"	5µm	3µm	flat back
2103-50F*	50.8mm/2"	6µm	3µm	flat back
2103-10*	12.7mm/0.5"	5µm	2µm	lug back
2103-25*	25.4mm/1"	5µm	3µm	lug back
2103-50*	50.8mm/2"	6µm	3µm	lug back

Resolution 0.01mm/0.0005"

Code	Range	Accuracy	Hysteresis	Remark
2104-10F*	12.7mm/0.5"	20µm	10µm	flat back
2104-25F*	25.4mm/1"	20µm	10µm	flat back
2104-50F*	50.8mm/2"	30µm	10µm	flat back
2104-10*	12.7mm/0.5"	20µm	10µm	lug back
2104-25*	25.4mm/1"	20µm	10µm	lug back
2104-50*	50.8mm/2"	30µm	10µm	lug back

* Supplied with manufacturer inspection certificate traceable to NIST USA

**INSPECTION
CERTIFICATE**
TRACEABLE TO NIST

ONE BATTERY FOR
4000 WORKING HOURS

DATA
OUTPUT

NO AUTO POWER OFF DIGITAL INDICATORS

spindle lift knob is included



- No auto power off, tracking the deformation of mould and steel structure for a long time
- Low power consumption
- Button function: on/off, zero, inch/mm
- CR2032 battery
- Data output
- Optional accessory: data output cable (code 7315-, 7302-, 7305-), backs (page 129~130), contact points (page 126~128)

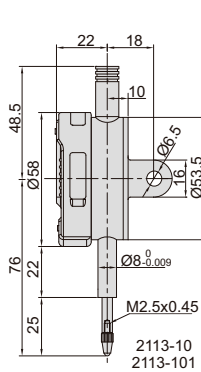

2113-10

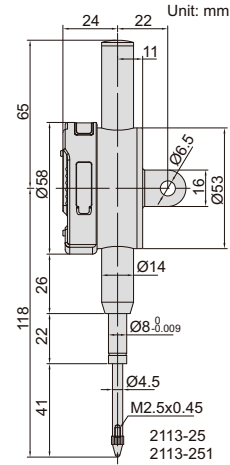

2113-251

Resolution 0.001mm/0.00005"

Code	Range	Accuracy	Hysteresis	Remark
2113-101F *	12.7mm/0.5"	5µm	2µm	flat back
2113-251F *	25.4mm/1"	5µm	3µm	flat back
2113-101 *	12.7mm/0.5"	5µm	2µm	lug back
2113-251 *	25.4mm/1"	5µm	3µm	lug back

Resolution 0.01mm/0.0005"

Code	Range	Accuracy	Hysteresis	Remark
2113-10F *	12.7mm/0.5"	20µm	10µm	flat back
2113-25F *	25.4mm/1"	20µm	10µm	flat back
2113-10 *	12.7mm/0.5"	20µm	10µm	lug back
2113-25 *	25.4mm/1"	20µm	10µm	lug back

*Supplied with manufacturer inspection certificate traceable to NIST USA

**INSPECTION
CERTIFICATE**
TRACEABLE TO NIST

WATERPROOF

DATA
OUTPUT

spindle lift knob is included (except 2115-101/101F, 2115-10/10F)

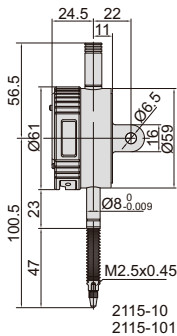

2115-10

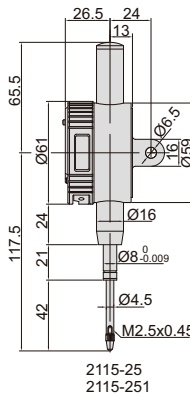

2115-25

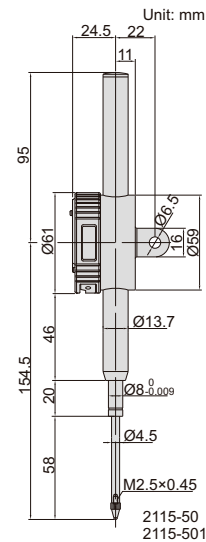

2115-50

Resolution 0.001mm/0.00005"

Code	Range	Dust/waterproof	Accuracy	Hysteresis	Remark
2115-101 *	12.7mm/0.5"	IP65	5µm	2µm	lug back
2115-251 *	25.4mm/1"	IP54	5µm	3µm	lug back
2115-501 *	50.8mm/2"	IP54	6µm	3µm	lug back
2115-101F *	12.7mm/0.5"	IP65	5µm	2µm	flat back
2115-251F *	25.4mm/1"	IP54	5µm	3µm	flat back
2115-501F *	50.8mm/2"	IP54	6µm	3µm	flat back

Resolution 0.01mm/0.0005"

Code	Range	Dust/waterproof	Accuracy	Hysteresis	Remark
2115-10 *	12.7mm/0.5"	IP65	20µm	10µm	lug back
2115-25 *	25.4mm/1"	IP54	20µm	10µm	lug back
2115-50 *	50.8mm/2"	IP54	30µm	10µm	lug back
2115-10F *	12.7mm/0.5"	IP65	20µm	10µm	flat back
2115-25F *	25.4mm/1"	IP54	20µm	10µm	flat back
2115-50F *	50.8mm/2"	IP54	30µm	10µm	flat back

- Dust/waterproof
- Button function: on/off, zero, mm/inch
- CR2032 battery, automatic power off
- Data output
- Optional accessory: data output cable (code 7315-, 7302-, 7305-), backs (page 129~130), contact points (page 126~128)

*Supplied with manufacturer inspection certificate traceable to NIST USA

ADJUSTABLE COEFFICIENT DIGITAL INDICATORS

■ DISPLAY READING = COEFFICIENT X SPINDLE MOVEMENT.

The coefficient can be adjusted from 0 to 9.9999. For example, coefficient is 4.5562, spindle moves 3.60mm, display reading is 4.5562 x 3.60=16.40mm

- Button function: on/off, zero, data preset, inch/mm, coefficient set, measuring direction change
- Keep preset data in memory after restart
- CR2032 battery, automatic power off
- Data output
- Optional accessory: data output cable (code 7315-, 7302-, 7305-), backs (page 129~130), contact points (page 126~128)



2501-10

DATA OUTPUT

INSPECTION CERTIFICATE TRACEABLE TO NIST

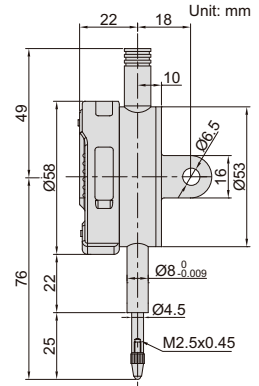

Code	Range	Resolution	Accuracy	Hysteresis	Remark
2501-10*	12.7mm/0.5"	0.01mm/0.0005"	20µm	10µm	lug back
2501-10F*	12.7mm/0.5"	0.01mm/0.0005"	20µm	10µm	flat back

*Supplied with manufacturer inspection certificate traceable to NIST USA

DIGITAL INDICATORS FOR BORE GAGES

- Specially designed for bore gages
- The minimum value tracking function can find the diameter automatically
- Read the diameter directly, after inputting the size of setting ring
- Reading in digital and analog
- Display can be rotated by 320°
- Button function: minimum value tracking, calibration, data preset, inch/metric conversion, absolute/incremental measurement
- Keep preset data in memory after restart
- CR2032 battery, automatic power off
- Data output
- Optional accessory: data output cable (code 7315-, 7302-, 7305-), backs (page 129~130), contact points (page 126~128), spindle lift knob (code 7332)



2108-10F

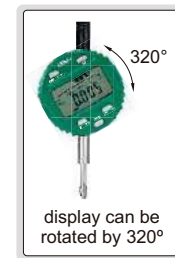
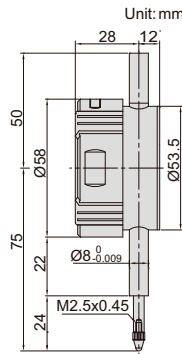

INSPECTION CERTIFICATE TRACEABLE TO NIST

DATA OUTPUT



Read the diameter directly, after inputting the size of setting ring.

The minimum value tracking function can find the diameter automatically.

Code	Range	Resolution	Accuracy	Hysteresis	Remark
2108-10F*	12.7mm/0.5"	0.002mm/0.0001"	20µm	10µm	flat back
2108-101F*	12.7mm/0.5"	0.001mm/0.00005"	5µm	2µm	flat back

*Supplied with manufacturer inspection certificate traceable to NIST USA

DIGITAL INDICATORS WITH LIFTING LEVER

INSPECTION CERTIFICATE TRACEABLE TO NIST

DATA OUTPUT

- Reading in digital and analog
- Display can be rotated by 320°
- Button function: tolerance Go and No-Go display, data preset, measuring direction change, max./min./TIR measurement, inch/metric conversion, absolute/incremental measurement
- Keep preset data and tolerance data in memory after restart
- CR2032 battery, automatic power off
- Data output
- Optional accessory: data output cable (code 7315-, 7302-, 7305-), backs (page 129~130), contact points (page 126~128)

warning when over tolerance



analog pointer



2109-10

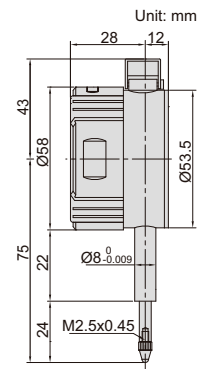

Code	Range	Resolution	Accuracy	Hysteresis	Remark
2109-10*	10mm/0.4"	0.01mm/0.0005"	20µm	10µm	flat back
2109-101*	10mm/0.4"	0.001mm/0.00005"	5µm	2µm	flat back

*Supplied with manufacturer inspection certificate traceable to NIST USA

BACK PLUNGER TYPE DIGITAL INDICATORS

**INSPECTION
CERTIFICATE**
TRACEABLE TO NIST

DATA
OUTPUT

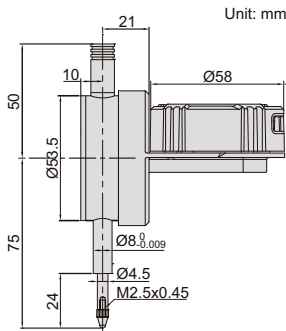

2118-10

display can rotate 320°

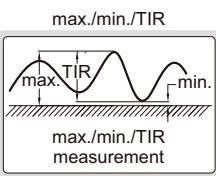

spindle lift knob
is included



warning when
over tolerance



analog pointer

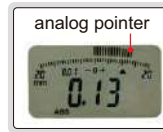

- Display can rotate 320°, and display direction is changeable
- Reading in digital and analog
- Button function: tolerance Go and No-Go display, data preset, measuring direction change, max./min./TIR measurement, inch/metric conversion, absolute/incremental measurement
- Keep preset data and tolerance data in memory after restart
- CR2032 battery, automatic power off
- Data output
- Optional accessory: data output cable (code 7315-, 7302-, 7305-), backs (page 129~130), contact points (page 126~128)

display direction is changeable

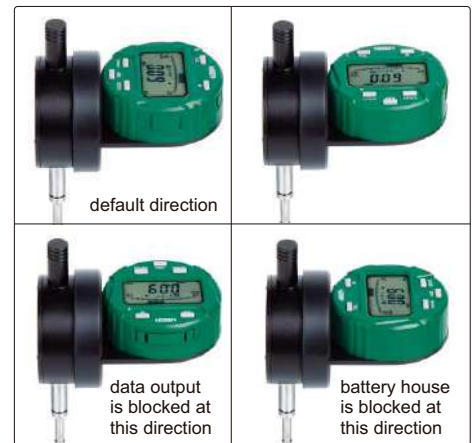

Remark: To change above direction, 4 fixing screws on the back of display need to be removed first.

Code	Range	Resolution	Accuracy	Hysteresis	Remark
2118-10 *	12.7mm/0.5"	0.01mm/0.0005"	20µm	10µm	flat back
2118-101 *	12.7mm/0.5"	0.001mm/0.00005"	5µm	2µm	flat back

*Supplied with manufacturer inspection certificate traceable to NIST USA

**INSPECTION
CERTIFICATE**
TRACEABLE TO NIST

DATA
OUTPUT

COMPACT DIGITAL INDICATORS

- Button function:
 - in/mm: short press for inch/metric conversion
 - long press to change measuring direction
 - ABS: short press for absolute/incremental measurement
 - long press to preset data
 - O/ON: short press to turn on when power is off
 - short press to set zero when power is on
 - long press to turn off
- Keep preset data in memory after restart
- CR1632 battery, automatic power off
- Data output
- Optional accessory: data output cable (code 7315-, 7302-, 7305-), contact points (page 126~128)

Code	Range	Resolution	Accuracy	Hysteresis	Remark
2114-5F *	5mm/0.2"	0.01mm/0.0005"	20µm	10µm	flat back
2114-51F *	5mm/0.2"	0.001mm/0.00005"	5µm	2µm	flat back

*Supplied with manufacturer inspection certificate traceable to NIST USA



2114-51F

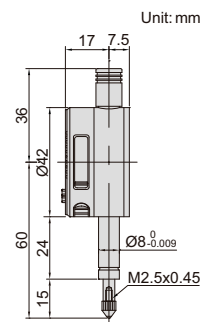

LARGE STROKE DIGITAL INDICATORS

DATA OUTPUT

spindle lift knob is included



- Button function: on/off, zero, mm/inch
- CR2032 battery, automatic power off
- Data output
- Optional accessory: data output cable (code 7315-, 7302-, 7305-), backs (page 129~130), contact points (page 126~128)

Resolution 0.01mm/0.0005"

Code	Range	Accuracy	Hysteresis	Remark
2117-100	100mm/4"	30µm	10µm	lug back

Resolution 0.001mm/0.00005"

Code	Range	Accuracy	Hysteresis	Remark
2117-1001	100mm/4"	9µm	3µm	lug back



2117-100

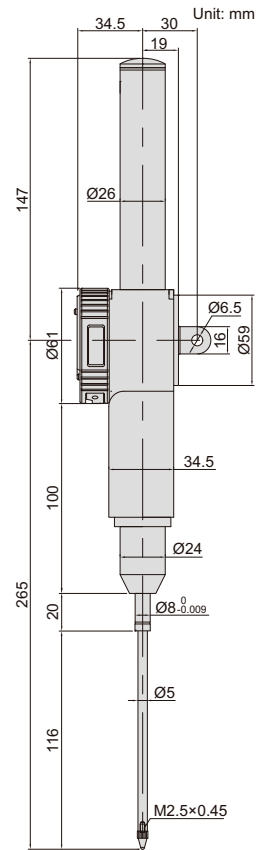

DIAL COMPARATOR

INSIZE PLUS
MADE IN GERMANY

JEWELLED BEARING

SHOCK PROOF

INSPECTION CERTIFICATE
TRACEABLE TO NIST

- Meet DIN879-1
- Shockproof
- Jeweled bearing
- Overtravel: 3mm
- Shadow free dial face cover
- Supplied with limit pointers
- Initial measuring force 1.2N
- Optional accessory: lifting lever (code 6289-150)

lifting lever (optional)



2881-01

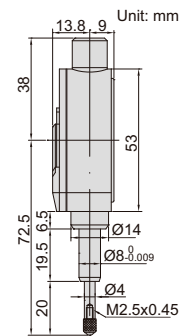

Code	Range	Graduation	Accuracy	Hysteresis	Dial reading	Remark
2881-01*	0.1mm	0.001mm	1.2µm	0.5µm	50-0-50	flat back

*Supplied with manufacturer inspection certificate traceable to NIST USA

HIGH PRECISION COMPACT DIAL INDICATORS

INSIZE PLUS
MADE IN GERMANY

SHOCK PROOF

INSPECTION CERTIFICATE
TRACEABLE TO NIST

- Shockproof
- Jeweled bearing
- With limit pointers
- Optional accessory: backs (page 129~130), contact points (page 126~128), lifting lever (code 6289-150)

lifting lever (optional)

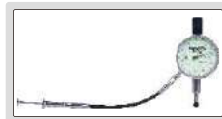

2890-1

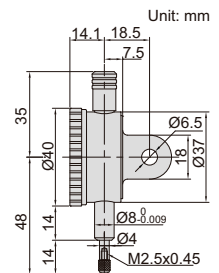

Code	Range	Graduation	Accuracy	Hysteresis	Range/rev	Dial reading	Remark
2890-1*	1mm	0.001mm	3µm	1.5µm	0.1mm	0-100	lug back
2890-1F*	1mm	0.001mm	3µm	1.5µm	0.1mm	0-100	flat back

*Supplied with manufacturer inspection certificate traceable to NIST USA

**INSPECTION
CERTIFICATE**
TRACEABLE TO NIST

SHOCK
PROOF

HIGH PRECISION DIAL INDICATORS

INSIZE PLUS
MADE IN GERMANY

- Shockproof
- Jeweled bearing
- With limit pointers
- Optional accessory: backs (page 129~130), contact points (page 126~128), lifting lever (code 6289-150)



2891-1

lifting lever (optional)

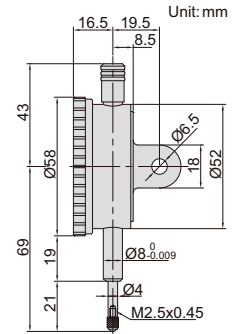

Code	Range	Graduation	Accuracy	Hysteresis	Range/rev	Dial reading	Remark
2891-1 *	1mm	0.001mm	3µm	1.5µm	0.1mm	0-100	lug back
2891-1F *	1mm	0.001mm	3µm	1.5µm	0.1mm	0-100	flat back

* Supplied with manufacturer inspection certificate traceable to NIST USA

**INSPECTION
CERTIFICATE**
TRACEABLE TO NIST

SHOCK
PROOF

JEWELLED
BEARING

PRECISION DIAL INDICATORS

INSIZE PLUS
MADE IN GERMANY

- Shockproof
- Jeweled bearing
- With limit pointers
- Optional accessory: backs (page 129~130), contact points (page 126~128)



2830-1

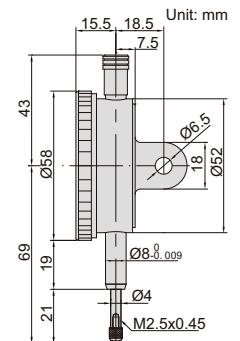

Code	Range	Graduation	Accuracy	Hysteresis	Range/rev	Dial reading	Remark
2830-1 *	1mm	0.001mm	5µm	2µm	0.2mm	0-100-0	lug back
2830-1F *	1mm	0.001mm	5µm	2µm	0.2mm	0-100-0	flat back

* Supplied with manufacturer inspection certificate traceable to NIST USA

**INSPECTION
CERTIFICATE**
TRACEABLE TO NIST

COMPACT DIAL INDICATOR

- Meet DIN878
- With limit pointers
- Optional accessory: backs (page 129~130), contact points (page 126~128)



2886-3F

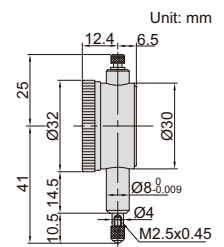

Code	Range	Graduation	Accuracy	Hysteresis	Range/rev	Dial reading	Remark
2886-3F *	3mm	0.01mm	12µm	3µm	0.5mm	0-50	flat back

* Supplied with manufacturer inspection certificate traceable to NIST USA

**INSPECTION
CERTIFICATE**
TRACEABLE TO NIST

COMPACT DIAL INDICATORS

INSIZE PLUS
MADE IN GERMANY

- Meet DIN878
- With limit pointers
- Optional accessory: backs (page 129~130), contact points (page 126~128)



2887-5

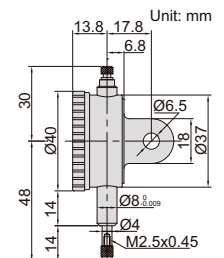

Code	Range	Graduation	Accuracy	Hysteresis	Range/rev	Dial reading	Remark
2887-5 *	5mm	0.01mm	14µm	3µm	0.5mm	0-50	lug back
2887-5F *	5mm	0.01mm	14µm	3µm	0.5mm	0-50	flat back

* Supplied with manufacturer inspection certificate traceable to NIST USA

LARGE DIAL FACE DIAL INDICATOR

INSIZE PLUS
MADE IN GERMANY

- Large, easy-to-read dial face
- With limit pointers
- Optional accessory: backs (page 129~130), contact points (page 126~128)



2888-10

INSPECTION CERTIFICATE
TRACEABLE TO NIST

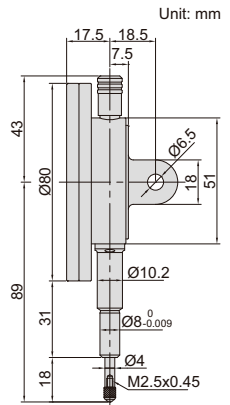

Code	Range	Graduation	Accuracy	Hysteresis	Range/rev	Dial reading	Remark
2888-10*	10mm	0.01mm	17µm	5µm	1mm	0-100	flat back, with spare lug back

*Supplied with manufacturer inspection certificate traceable to NIST USA

7

DIAL INDICATORS

INSIZE PLUS
MADE IN GERMANY

- Meet DIN878
- With limit pointers
- Optional accessory: backs (page 129~130), contact points (page 126~128)



2892-10

INSPECTION CERTIFICATE
TRACEABLE TO NIST

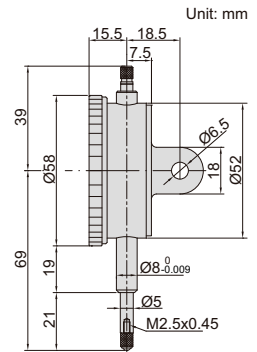

Code	Range	Graduation	Accuracy	Hysteresis	Range/rev	Dial reading	Remark
2892-10*	10mm	0.01mm	17µm	3µm	1mm	0-100	lug back
2892-10F*	10mm	0.01mm	17µm	3µm	1mm	0-100	flat back

*Supplied with manufacturer inspection certificate traceable to NIST USA

BACK PLUNGER DIAL INDICATOR

INSIZE PLUS
MADE IN GERMANY

- With limit pointers
- Optional accessory: contact points (page 126~128)



2893-3

INSPECTION CERTIFICATE
TRACEABLE TO NIST

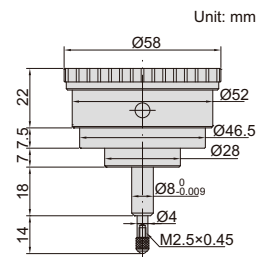

Code	Range	Graduation	Accuracy	Hysteresis	Range/rev	Dial reading
2893-3*	3mm	0.01mm	15µm	5µm	1mm	0-100

*Supplied with manufacturer inspection certificate traceable to NIST USA

WATERPROOF DIAL INDICATOR

INSIZE PLUS
MADE IN GERMANY

SHOCK PROOF **IP67 WATERPROOF**

- Meet DIN878
- Shockproof
- IP67 dust/waterproof
- With limit pointers
- Optional accessory: contact points (page 126~128)



2894-10F

INSPECTION CERTIFICATE
TRACEABLE TO NIST

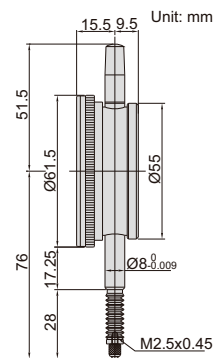

Code	Range	Graduation	Accuracy	Hysteresis	Range/rev	Dial reading	Remark
2894-10F*	10mm	0.01mm	17µm	3µm	1mm	0-100	flat back

*Supplied with manufacturer inspection certificate traceable to NIST USA



DIAL INDICATORS (LONG STROKE)



2889-30

- With limit pointers
- Optional accessory: backs (page 129~130), contact points (page 126~128)

Code	Range	Graduation	Accuracy	Hysteresis	Range/rev	Dial reading	Remark
2889-30 *	30mm	0.01mm	25µm	5µm	1mm	0-100	lug back
2889-30F *	30mm	0.01mm	25µm	5µm	1mm	0-100	flat back

* Supplied with manufacturer inspection certificate traceable to NIST USA

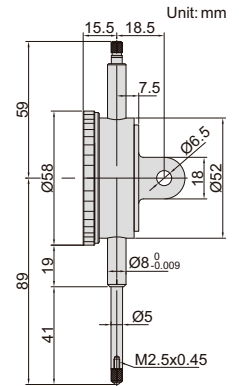

ONE REVOLUTION PRECISION DIAL INDICATORS



lifting lever (optional)

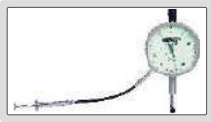

2885-008

- Eliminate the possibility of reading errors due to miscounting
- Shockproof
- Jeweled bearing
- Free stroke: 4.5mm
- With limit pointers
- Optional accessory: backs (page 129~130), contact points (page 126~128), lifting lever (code 6289-150)

Code	Range	Graduation	Accuracy	Hysteresis	Dial reading	Remark
2885-008 *	0.08mm	0.001mm	3µm	1.5µm	40-0-40	lug back
2885-008F *	0.08mm	0.001mm	3µm	1.5µm	40-0-40	flat back

* Supplied with manufacturer inspection certificate traceable to NIST USA

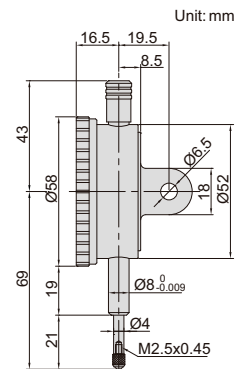

ONE REVOLUTION DIAL INDICATORS



- Meet DIN878
- Eliminate the possibility of reading errors due to miscounting
- Shockproof
- Free stroke: 7mm
- With limit pointers
- Optional accessory: backs (page 129~130), contact points (page 126~128)



2882-08

Code	Range	Graduation	Accuracy	Hysteresis	Dial reading	Remark
2882-08 *	0.8mm	0.01mm	9µm	3µm	40-0-40	lug back
2882-08F *	0.8mm	0.01mm	9µm	3µm	40-0-40	flat back

* Supplied with manufacturer inspection certificate traceable to NIST USA

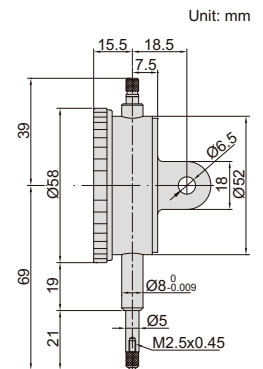

PRECISION DIAL INDICATORS

- Graduation: 0.001mm
- Jeweled bearing
- Supplied with limit pointers and bezel clamp
- Optional accessory: backs (page 129~130), contact points (page 126~128)



2313-1A

JEWELLED BEARING

INSPECTION CERTIFICATE
TRACEABLE TO NIST

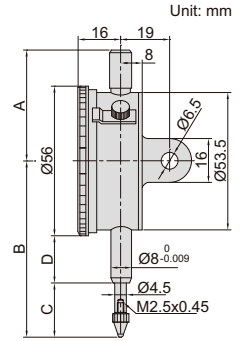

Code	Range	Accuracy	Hysteresis	Range/rev	Dial reading	Remark	A	B	C	D
2313-1FA *	1mm	5µm	2µm	0.2mm	0-100-0	flat back	45	62.5	19.5	15
2313-2FA *	2mm	8µm	2.5µm	0.2mm	0-100-0	flat back	45	62.5	19.5	15
2313-1A *	1mm	5µm	2µm	0.2mm	0-100-0	lug back	45	62.5	19.5	15
2313-2A *	2mm	8µm	2.5µm	0.2mm	0-100-0	lug back	45	62.5	19.5	15

*Supplied with manufacturer inspection certificate traceable to NIST USA

COMPACT DIAL INDICATORS

- Meet DIN878
- Jeweled bearing
- Supplied with limit pointers and bezel clamp
- Optional accessory: backs (page 129~130), contact points (page 126~128)



2311-5

JEWELLED BEARING

INSPECTION CERTIFICATE
TRACEABLE TO NIST

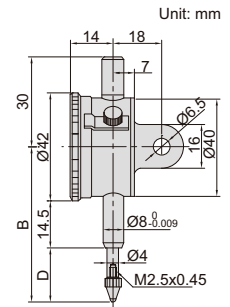

Code	Range	Graduation	Accuracy	Hysteresis	Range/rev	Dial reading	Remark	B	D
2311-3F *	3mm	0.01mm	12µm	3µm	0.5mm	0-50	flat back	46	10.5
2311-5F *	5mm	0.01mm	14µm	3µm	0.5mm	0-50	flat back	48	12.5
2311-3 *	3mm	0.01mm	12µm	3µm	0.5mm	0-50	lug back	46	10.5
2311-5 *	5mm	0.01mm	14µm	3µm	0.5mm	0-50	lug back	48	12.5

*Supplied with manufacturer inspection certificate traceable to NIST USA

DIAL INDICATORS (BASIC TYPE)

- Meet DIN878
- Jeweled bearing
- Supplied with limit hands and bezel clamp
- Packed in carton box
- Optional accessory: backs (page 129~130), contact points (page 126~128)



2301-10

INSPECTION CERTIFICATE
TRACEABLE TO NIST

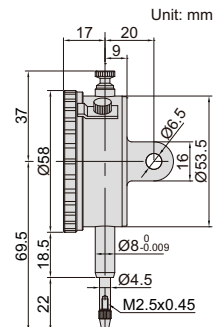

Code	Range	Graduation	Accuracy	Hysteresis	Range/rev	Dial reading	Remark
2301-10F *	10mm	0.01mm	17µm	3µm	1mm	0-100	flat back
2301-10 *	10mm	0.01mm	17µm	3µm	1mm	0-100	lug back with spare flat back

*Supplied with manufacturer inspection certificate traceable to NIST USA

**INSPECTION
CERTIFICATE**
TRACEABLE TO NIST

JEWELLED
BEARING

DIAL INDICATORS (STANDARD TYPE)

- Meet DIN878
- Jeweled bearing
- Supplied with limit pointers and bezel clamp
- Optional accessory: backs (page 129~130), contact points (page 126~128)



2308-10A

Code	Range	Graduation	Accuracy	Hysteresis	Range/rev	Dial reading	Remark
2308-3FA *	3mm	0.01mm	12 μ m	3 μ m	1mm	0-100	flat back
2308-5FA *	5mm	0.01mm	14 μ m	3 μ m	1mm	0-100	flat back
2308-10FA *	10mm	0.01mm	17 μ m	3 μ m	1mm	0-100	flat back
2308-3A *	3mm	0.01mm	12 μ m	3 μ m	1mm	0-100	lug back
2308-5A *	5mm	0.01mm	14 μ m	3 μ m	1mm	0-100	lug back
2308-10A *	10mm	0.01mm	17 μ m	3 μ m	1mm	0-100	lug back

*Supplied with manufacturer inspection certificate traceable to NIST USA

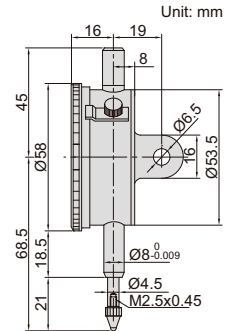

7

**INSPECTION
CERTIFICATE**
TRACEABLE TO NIST

JEWELLED
BEARING

REVERSE READING DIAL INDICATORS

- Meet DIN878
- Suitable for depth and step measurements
- Jeweled bearing
- Supplied with limit pointers and bezel clamp
- Optional accessory: backs (page 129~130), contact points (page 126~128)



2801-10

Code	Range	Graduation	Accuracy	Hysteresis	Range/rev	Dial reading	Remark
2801-10F *	10mm	0.01mm	17 μ m	3 μ m	1mm	100-0	flat back
2801-10 *	10mm	0.01mm	17 μ m	3 μ m	1mm	100-0	lug back

*Supplied with manufacturer inspection certificate traceable to NIST USA

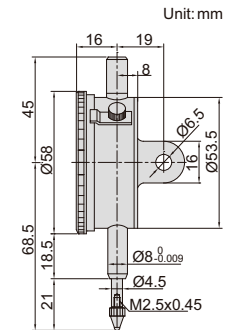

**INSPECTION
CERTIFICATE**
TRACEABLE TO NIST

SHOCK
PROOF

JEWELLED
BEARING

SHOCKPROOF DIAL INDICATORS

- Meet DIN878
- Shockproof
- Jeweled bearing
- Supplied with limit pointers and bezel clamp
- Optional accessory: backs (page 129~130), contact points (page 126~128)



2314-10A

Code	Range	Graduation	Accuracy	Hysteresis	Range/rev	Dial reading	Remark
2314-3FA *	3mm	0.01mm	12 μ m	3 μ m	1mm	0-100	flat back
2314-5FA *	5mm	0.01mm	14 μ m	3 μ m	1mm	0-100	flat back
2314-10FA *	10mm	0.01mm	17 μ m	3 μ m	1mm	0-100	flat back
2314-3A *	3mm	0.01mm	12 μ m	3 μ m	1mm	0-100	lug back
2314-5A *	5mm	0.01mm	14 μ m	3 μ m	1mm	0-100	lug back
2314-10A *	10mm	0.01mm	17 μ m	3 μ m	1mm	0-100	lug back

*Supplied with manufacturer inspection certificate traceable to NIST USA

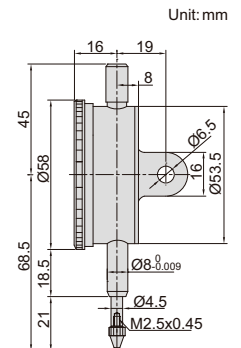

BACK PLUNGER TYPE DIAL INDICATOR

**INSPECTION
CERTIFICATE**
TRACEABLE TO NIST



2357-5

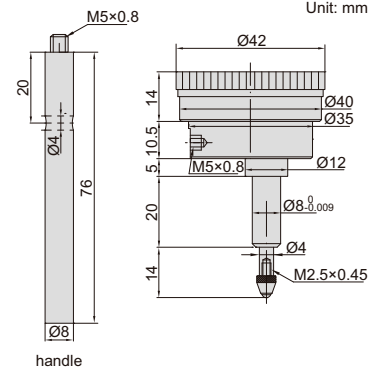

- Supplied with handle
- With limit pointers
- Optional accessory: contact points (page 126~128)

Code	Range	Graduation	Accuracy	Hysteresis	Range/rev	Dial reading
2357-5*	5mm	0.01mm	15µm	5µm	1mm	0-100

*Supplied with manufacturer inspection certificate traceable to NIST USA

7

WATERPROOF DIAL INDICATORS

**INSPECTION
CERTIFICATE**
TRACEABLE TO NIST

IP54
WATERPROOF



2324-10A

- Meet DIN878
- IP54 dust/waterproof
- With limit pointers
- Optional accessory: backs (page 129~130), contact points (page 126~128)

Code	Range	Graduation	Accuracy	Hysteresis	Range/rev	Dial reading	Remark
2324-10FA*	10mm	0.01mm	17µm	3µm	1mm	0-100	flat back
2324-10A*	10mm	0.01mm	17µm	3µm	1mm	0-100	lug back

*Supplied with manufacturer inspection certificate traceable to NIST USA

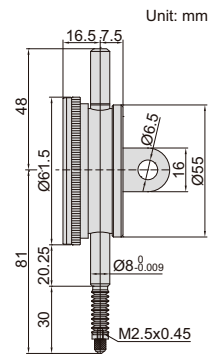

DOUBLE FACE DIAL INDICATOR

**INSPECTION
CERTIFICATE**
TRACEABLE TO NIST

- Meet DIN878
- Read from both sides
- Jeweled bearing
- Supplied with limit pointers
- Optional accessory: contact points (page 126~128)



front

back

2328-10

Code	Range	Graduation	Accuracy	Hysteresis	Range/rev	Dial reading
2328-10*	10mm	0.01mm	17µm	3µm	1mm	0-100

*Supplied with manufacturer inspection certificate traceable to NIST USA

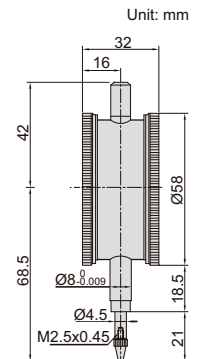

DIAL INDICATORS (LONG STROKE)

- Supplied with limit pointers and bezel clamp
- Optional accessory: backs (page 129~130), contact points (page 126~128)



2310-30A

(mm)

Code	Range	Graduation	Accuracy	Hysteresis	Range/rev	Dial reading	Remark	B	D
2310-20FA *	20mm	0.01mm	25μm	5μm	1mm	0-100	flat back	83	35
2310-30FA *	30mm	0.01mm	35μm	7μm	1mm	0-100	flat back	88	40
2310-20A *	20mm	0.01mm	25μm	5μm	1mm	0-100	lug back	83	35
2310-30A *	30mm	0.01mm	35μm	7μm	1mm	0-100	lug back	88	40

*Supplied with manufacturer inspection certificate traceable to NIST USA

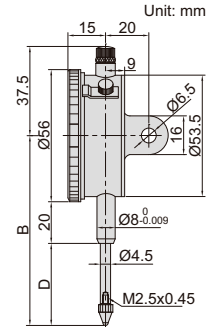

DIAL INDICATORS (LONG STROKE, BASIC TYPE)

- Supplied with limit pointers and bezel clamp
- Packed in carton box
- Optional accessory: backs (page 129~130), contact points (page 126~128)



2302-25

carton box



Code	Range	Graduation	Accuracy	Hysteresis	Range/rev	Dial reading	Remark
2302-25F *	25mm	0.01mm	35μm	7μm	1mm	0-100	flat back
2302-25 *	25mm	0.01mm	35μm	7μm	1mm	0-100	lug back with spare flat back

*Supplied with manufacturer inspection certificate traceable to NIST USA

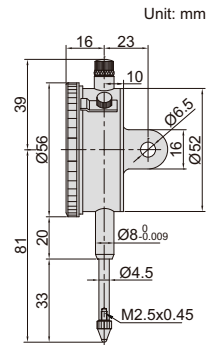

DIAL INDICATORS (GRADUATION 0.1mm)

- Supplied with limit pointers and bezel clamp
- Optional accessory: backs (page 129~130), contact points (page 126~128)



2318-30

(mm)

Code	Range	Graduation	Accuracy	Hysteresis	Range/rev	Dial reading	Remark	B	D
2318-10F	10mm	0.1mm	40μm	20μm	10mm	0-10	flat back	70	20
2318-20F	20mm	0.1mm	50μm	20μm	10mm	0-10	flat back	85	35
2318-25F	25mm	0.1mm	60μm	20μm	10mm	0-10	flat back	85	35
2318-30F	30mm	0.1mm	60μm	20μm	10mm	0-10	flat back	90	40
2318-10	10mm	0.1mm	40μm	20μm	10mm	0-10	lug back	70	20
2318-20	20mm	0.1mm	50μm	20μm	10mm	0-10	lug back	85	35
2318-25	25mm	0.1mm	60μm	20μm	10mm	0-10	lug back	85	35
2318-30	30mm	0.1mm	60μm	20μm	10mm	0-10	lug back	90	40

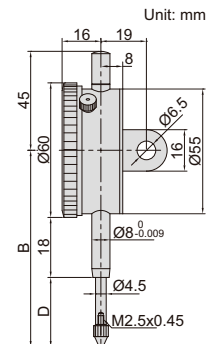

ONE REVOLUTION DIAL INDICATORS

SHOCK PROOF

INSPECTION CERTIFICATE
TRACEABLE TO NIST

- Meet DIN878
- Eliminate the possibility of reading errors due to miscounting
- Shockproof
- Supplied with limit pointers
- Optional accessory: backs (page 129~130), contact points (page 126~128)



2316-05

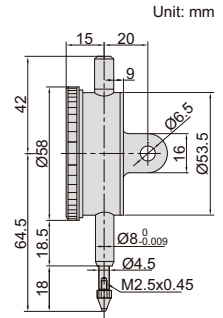

Code	Range	Graduation	Accuracy	Hysteresis	Dial reading	Remark
2316-05F *	0.5mm	0.01mm	9µm	3µm	25-0-25	flat back
2316-1F *	1mm	0.01mm	9µm	3µm	50-0-50	flat back
2316-05 *	0.5mm	0.01mm	9µm	3µm	25-0-25	lug back
2316-1 *	1mm	0.01mm	9µm	3µm	50-0-50	lug back

* Supplied with manufacturer inspection certificate traceable to NIST USA

DIAL INDICATORS (LONG STROKE)

JEWELLED BEARING

SHOCK PROOF

INSPECTION CERTIFICATE
TRACEABLE TO NIST

- Shockproof
- Jeweled bearing
- Supplied with limit pointers
- Optional accessory: backs (page 129~130), contact points (page 126~128)



2309-50

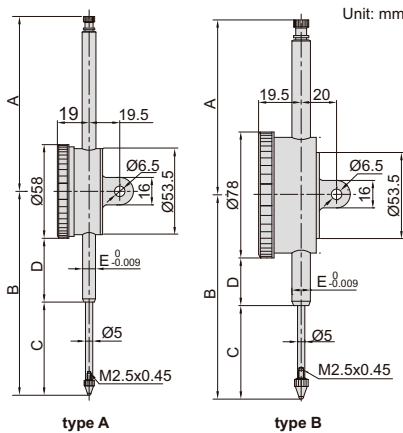

back of type B



stem clamp Ø10mm for 2309-100D



Code	Type	A	B	C	D	E
2309-30F	A	37.5	89.5	40.9	19.5	Ø8
2309-30	A	37.5	89.5	40.9	19.5	Ø8
2309-50	A	108.3	126.2	57.7	39.5	Ø8
2309-50D	B	108.3	126.2	57.7	29.5	Ø8
2309-80	A	138.4	168.4	88	51.3	Ø8
2309-80D	B	138.4	168.4	88	41.3	Ø8
2309-100D	B	167.6	207.8	108	60.8	Ø10

Code	Range	Graduation	Type	Accuracy	Hysteresis	Range/rev	Dial reading	Remark
2309-30F *	30mm	0.01mm	A	35µm	7µm	1mm	0-100	flat back
2309-30 *	30mm	0.01mm	A	35µm	7µm	1mm	0-100	lug back
2309-50 *	50mm	0.01mm	A	40µm	8µm	1mm	0-100	flat back with spare lug back
2309-50D *	50mm	0.01mm	B	40µm	8µm	1mm	0-100	flat back with spare lug back
2309-80	80mm	0.01mm	A	50µm	9µm	1mm	0-100	flat back with spare lug back
2309-80D	80mm	0.01mm	B	50µm	9µm	1mm	0-100	flat back with spare lug back
2309-100D	100mm	0.01mm	B	50µm	9µm	1mm	0-100	flat back with spare lug back

Note: 1) 2309-80, 2309-80D and 2309-100D can only be used vertically
 2) 2309-100D is supplied with stem clamp Ø10mm for magnetic stands (code 6200-60, 6201-60, 6202-80, 6202-100)
 3) 2309-30 and 2309-30F can not accept optional backs (page 129~130)

* Supplied with manufacturer inspection certificate traceable to NIST USA

BALL POINTS

Code	Material of measuring face	L (mm)
6282-0101	carbide	7.3
6282-0103	ceramic	7.3
6282-0104	carbide	8.3
6282-0106	carbide	12.1
6282-0107	carbide	14
6282-0108	carbide	15
6282-0109	ceramic	15
6282-0110	carbide	17

Code	Material of measuring face	L (mm)
6282-0111	carbide	19.3
6282-0112	carbide	20
6282-0113	ceramic	20
6282-0114	carbide	22
6282-0115	carbide	25
6282-0116	ceramic	25
6282-0117	carbide	30
6282-0118	ceramic	30



6282-0101

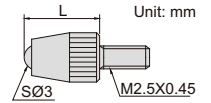

Code	Material of measuring face	SØD (mm)
6282-0301	steel	1
6282-0302	carbide	1.5
6282-0303	carbide	1.8

Code	Material of measuring face	SØD (mm)
6282-0304	carbide	2.5
6282-0305	carbide	4



6282-0301

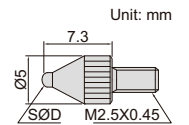

7

SHELL TYPE POINTS

Code	Material of measuring face	L (mm)
6282-0202	steel	5
6282-0203	steel	10
6282-0205	steel	15

Code	Material of measuring face	L (mm)
6282-0207	steel	20
6282-0208	steel	25
6282-0210	steel	30



6282-0202

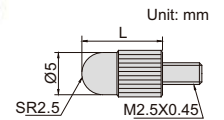

SPHERICAL POINT

Code	Material of measuring face
6282-0401	steel



6282-0401

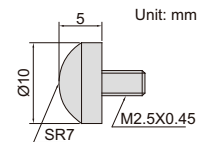

CONICAL POINTS

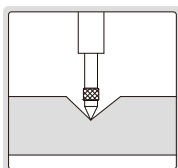

6282-0601



6282-0701



6282-0801



6282-0901

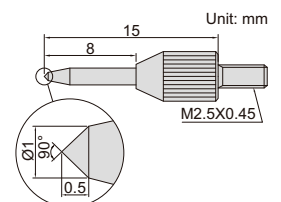
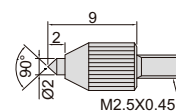
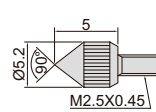
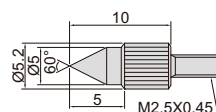

Code	Material of measuring face
6282-0601	steel
6282-0701	steel
6282-0801	steel
6282-0901	steel

KNIFE EDGE POINT

Code	Material of measuring face
6282-1001	steel



6282-1001

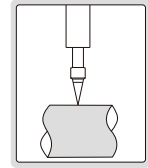
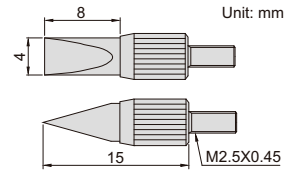

FLAT POINTS

7



6282-1101

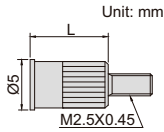

Code	Material of measuring face	L (mm)
6282-1101	steel	8
6282-1102	steel	10



6282-1201

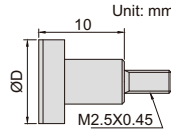

Code	Material of measuring face	ØD (mm)
6282-1201	steel	10
6282-1202	steel	15
6282-1203	steel	20
6282-1204	steel	25
6282-1205	steel	30

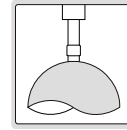

6282-1301

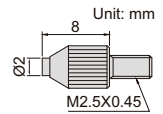

Code	Material of measuring face
6282-1301	carbide

NEEDLE POINTS



6282-1711

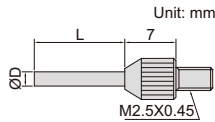

Code	Material of measuring face	ØD (mm)	L (mm)
6282-1701	steel	0.45	3
6282-1702	steel	0.45	5
6282-1703	carbide	1	3
6282-1704	carbide	1	5
6282-1705	carbide	1	8
6282-1706	carbide	1	10
6282-1707	carbide	1	20
6282-1708	carbide	1	40
6282-1709	carbide	1.5	5

Code	Material of measuring face	ØD (mm)	L (mm)
6282-1710	carbide	1.5	10
6282-1711	carbide	1.5	13
6282-1712	carbide	1.5	20
6282-1713	carbide	1.5	40
6282-1714	carbide	2	8
6282-1715	carbide	2	18
6282-1716	carbide	2	28
6282-1717	carbide	2	40

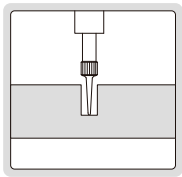

6282-1601

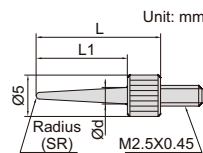

Code	Material of measuring face	L1 (mm)	L (mm)	SR (mm)	Ød (mm)
6282-1601	steel	11	15	0.4	2
6282-1602	steel	13	17	0.2	2
6282-1603	steel	21	25	0.4	3
6282-1604	steel	31	35	0.4	3

BLADE POINTS

Code	Material of measuring face	D (mm)	W (mm)
6282-1801	steel	0.4	2
6282-1802	steel	0.6	2
6282-1803	steel	1	4



6282-1801

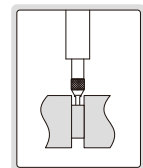
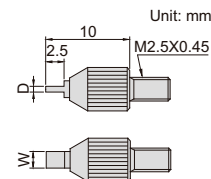

ROLLER POINT



6282-1901

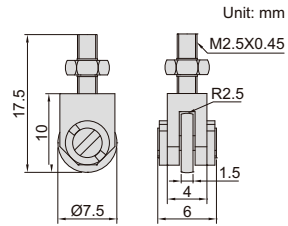

Code	Material of measuring face
6282-1901	steel

EXTENSION RODS

7



6282-2010

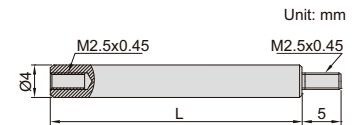

Code	Material	L (mm)
6282-2001	steel	10
6282-2002	steel	15
6282-2003	steel	20
6282-2004	steel	25
6282-2005	steel	30
6282-2006	steel	35
6282-2007	steel	40
6282-2008	steel	45
6282-2009	steel	50

Code	Material	L (mm)
6282-2010	steel	55
6282-2011	steel	60
6282-2012	steel	65
6282-2013	steel	70
6282-2014	steel	75
6282-2015	steel	80
6282-2016	steel	90
6282-2017	steel	100

POINT SET



6282-S6

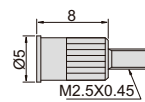

Flat Point

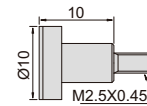

Flat Point

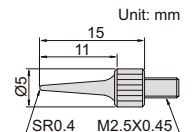

Needle Point

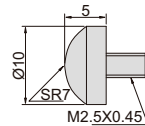

Spherical Point

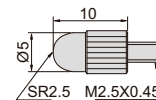

Shell Type Point

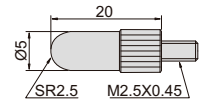

Shell Type Point

Code	Material of measuring face
6282-S6	steel

SPINDLE LIFT KNOB

- For dial/digital indicators with spindle diameter Ø4.5mm or Ø5mm



7332

Code
7332

FLAT BACKS

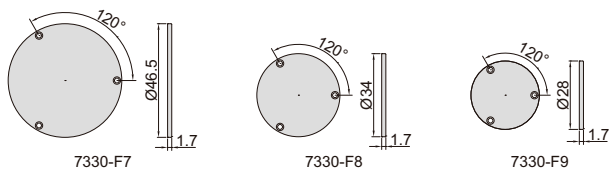
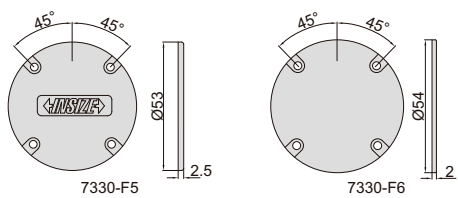
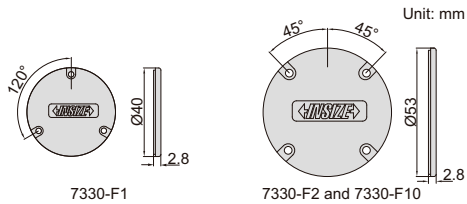

7330-F2



7330-F8

Code	For digital/dial indicators
7330-F1	2311
	2301
	2302
	2308
	2309 (except 2309-30, 2309-30F)
	2313
	2314
	2801
7330-F5	2103
	2104
	2108
	2109
	2112
	2113

Code	For digital/dial indicators
7330-F5	2115
	2116
	2118
7330-F6	2318
7330-F7	2830
	2882
	2885
	2888
	2889
	2891
	2892
7330-F8	2890
7330-F9	2887
7330-F10	2886
	2310

LUG BACKS

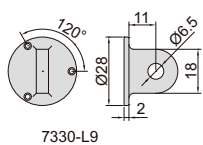
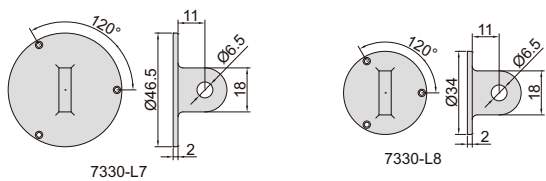
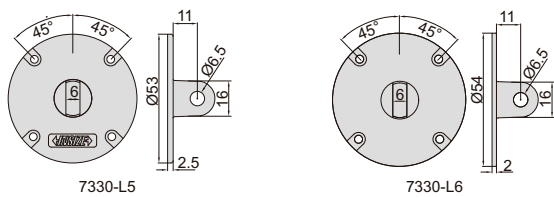
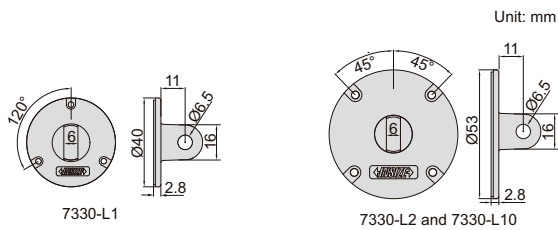

7330-L2



7330-L8

Code	For digital/dial indicators
7330-L1	2311
	2301
	2302
	2308
	2309 (except 2309-30, 2309-30F)
	2313
	2314
	2801
7330-L5	2103
	2104
	2108
	2109
	2112
	2113

Code	For digital/dial indicators
7330-L5	2115
	2116
	2117
7330-L6	2118
7330-L7	2318
	2830
	2882
	2885
	2888
	2889
	2891
2892	
7330-L8	2890
7330-L9	2887
7330-L10	2886
	2310

MAGNETIC BACKS

Code	ØD	For digital/dial indicators
7331-M1	51.5	2103
		2104
		2108
		2109
		2112
		2113
		2115
		2116
		2117
		2118
		2301
		2302
2308		

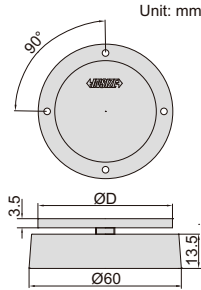

front



back

7331-M2

Code	ØD	For digital/dial indicators
7331-M1	51.5	2309 (except 2309-30, 2309-30F)
		2313
		2314
		2316
		2801
7331-M2	54	2318



ANTI MAGNETIC CARBIDE CONTACT POINT

PRECISION DIAL TEST INDICATOR

INSIZE PLUS MADE IN GERMANY

- Meet DIN2270
- Ceramic bearing
- Anti magnetic carbide contact point
- Two measuring directions
- Supplied with one clamp: diameter Ø8mm
- Optional accessory: styli (page 134)

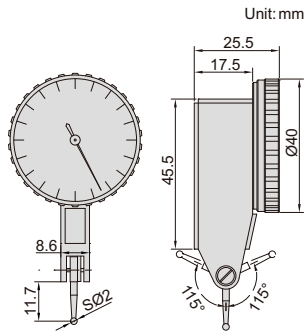

2897-02

clamp (included)

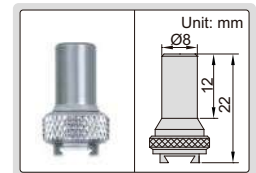

Code	Range	Graduation	Accuracy	Hysteresis	Dial reading
2897-02 *	0.2mm	0.001mm	4µm	2µm	0-100-0

*Supplied with manufacturer inspection certificate traceable to NIST USA



PRECISION DIAL TEST INDICATORS

INSIZE PLUS MADE IN GERMANY

- Meet DIN2270
- Ceramic bearing
- Two measuring directions
- Supplied with one clamp: diameter Ø8mm
- Optional accessory: styli (page 134)

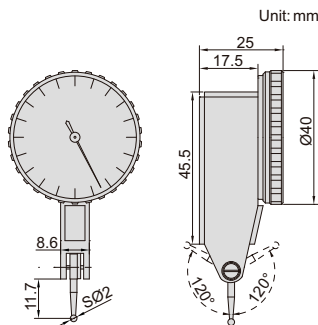

2880-02

ruby contact point of 2880-02R



clamp (included)

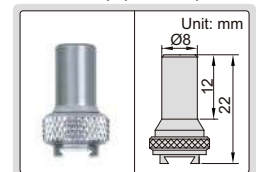

Code	Range	Graduation	Accuracy	Hysteresis	Dial reading	Remark
2880-02 *	0.2mm	0.002mm	4µm	2µm	0-100-0	anti magnetic carbide contact point
2880-02R *	0.2mm	0.002mm	4µm	2µm	0-100-0	ruby contact point

*Supplied with manufacturer inspection certificate traceable to NIST USA

DIAL TEST INDICATOR

INSIZE PLUS
MADE IN GERMANY



2895-08

- Meet DIN2270
- Ceramic bearing
- Anti magnetic carbide contact point
- Two measuring directions
- Supplied with one clamp: diameter Ø8mm
- Optional accessory: styli (page 134)

Code	Range	Graduation	Accuracy	Hysteresis	Dial reading
2895-08 *	0.8mm	0.01mm	13µm	3µm	0-40-0

*Supplied with manufacturer inspection certificate traceable to NIST USA

INSPECTION CERTIFICATE
TRACEABLE TO NIST

ANTI MAGNETIC
CARBIDE CONTACT POINT

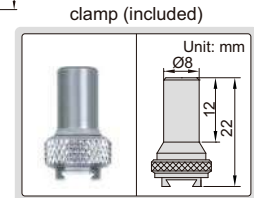
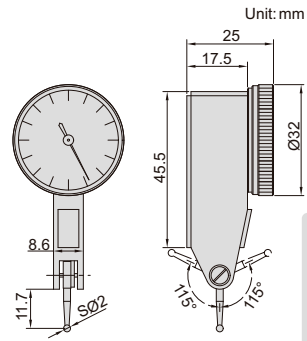

7

LONG STYLUS DIAL TEST INDICATOR

INSIZE PLUS
MADE IN GERMANY



2896-05

- Meet DIN2270
- Ceramic bearing
- Anti magnetic carbide contact point
- Two measuring directions
- Supplied with one clamp: diameter Ø8mm
- Optional accessory: styli (page 134)

Code	Range	Graduation	Accuracy	Hysteresis	Dial reading
2896-05 *	0.5mm	0.01mm	13µm	3µm	0-25-0

*Supplied with manufacturer inspection certificate traceable to NIST USA

INSPECTION CERTIFICATE
TRACEABLE TO NIST

ANTI MAGNETIC
CARBIDE CONTACT POINT

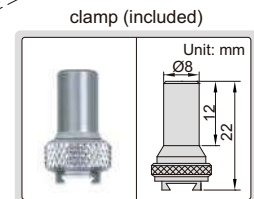
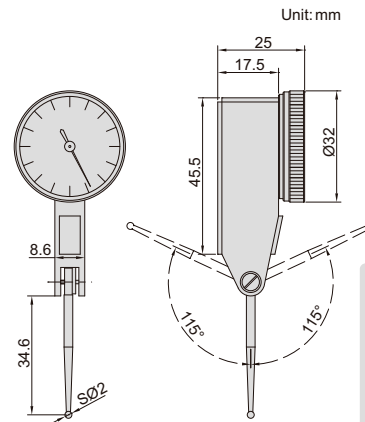

BACK PLUNGER LONG STYLUS DIAL TEST INDICATOR

INSIZE PLUS
MADE IN GERMANY



2899-05

- Meet DIN2270
- Ceramic bearing
- Anti magnetic carbide contact point
- Two measuring directions
- Supplied with one clamp: diameter Ø8mm
- Optional accessory: styli (page 134)

Code	Range	Graduation	Accuracy	Hysteresis	Dial reading
2899-05 *	0.5mm	0.01mm	13µm	3µm	0-25-0

*Supplied with manufacturer inspection certificate traceable to NIST USA

INSPECTION CERTIFICATE
TRACEABLE TO NIST

ANTI MAGNETIC
CARBIDE CONTACT POINT

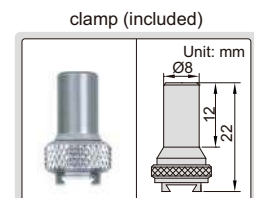
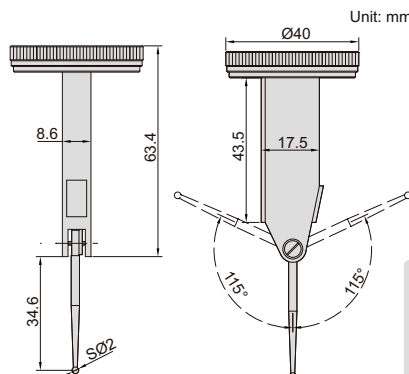

**INSPECTION
CERTIFICATE**
TRACEABLE TO NIST

ANTI MAGNETIC
CARBIDE CONTACT POINT

SIDE TYPE DIAL TEST INDICATOR

INSIZE PLUS
MADE IN GERMANY

- Meet DIN2270
- Ceramic bearing
- Anti magnetic carbide contact point
- Two measuring directions
- Supplied with one clamp:
diameter Ø8mm
- Optional accessory: styli (page 134)



2898-08

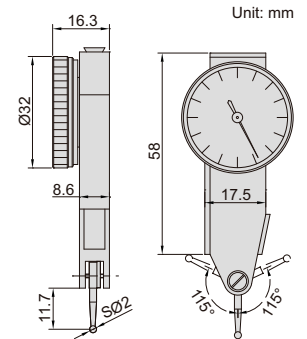
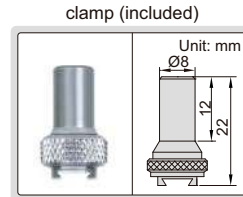

Code	Range	Graduation	Accuracy	Hysteresis	Dial reading
2898-08*	0.8mm	0.01mm	13µm	3µm	0-40-0

*Supplied with manufacturer inspection certificate traceable to NIST USA

**INSPECTION
CERTIFICATE**
TRACEABLE TO NIST

JEWELLED
BEARING

DIAL TEST INDICATORS

- Meet DIN2270
(except 2380-02, 2381-02)
- Jeweled bearing
- Carbide contact point
- Two measuring directions
- Anti magnetic body
- Supplied with two clamps:
diameter Ø4mm and Ø8mm
- Optional accessory: styli (page 134)

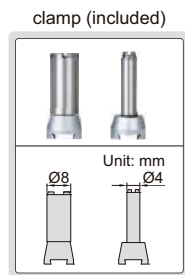

2380-08

(mm)

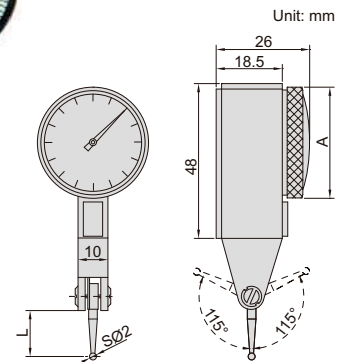

Code	Range	Graduation	Accuracy	Hysteresis	Dial reading	A	L
2380-08*	0.8mm	0.01mm	13µm	3µm	0-40-0	Ø30	13.5
2381-08*	0.8mm	0.01mm	13µm	3µm	0-40-0	Ø37	13.5
2380-02*	0.2mm	0.002mm	6µm	2µm	0-100-0	Ø30	12.5
2381-02*	0.2mm	0.002mm	6µm	2µm	0-100-0	Ø37	12.5

*Supplied with manufacturer inspection certificate traceable to NIST USA

**INSPECTION
CERTIFICATE**
TRACEABLE TO NIST

JEWELLED
BEARING

BACK PLUNGER TYPE DIAL TEST INDICATOR

- Meet DIN2270
- Jeweled bearing
- Carbide contact point
- Two measuring directions
- Anti magnetic body
- Supplied with two clamps:
diameter Ø4mm and Ø8mm
- Optional accessory: styli (page 134)

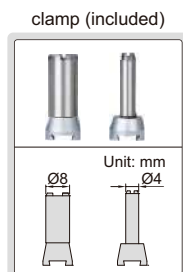

2398-08

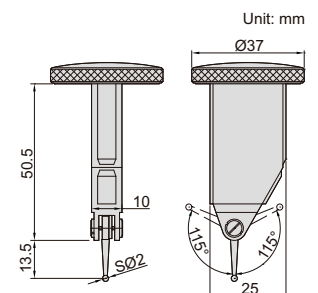

Code	Range	Graduation	Accuracy	Hysteresis	Dial reading
2398-08*	0.8mm	0.01mm	13µm	3µm	0-40-0

*Supplied with manufacturer inspection certificate traceable to NIST USA

TILTED FACE TYPE DIAL TEST INDICATOR

INSPECTION CERTIFICATE
TRACEABLE TO NIST

JEWELLED BEARING

- Meet DIN2270
- Jeweled bearing
- Carbide contact point
- Two measuring directions
- Anti magnetic body
- Supplied with two clamps: diameter $\varnothing 4\text{mm}$ and $\varnothing 8\text{mm}$
- Optional accessory: styli (page 134)

clamp (included)

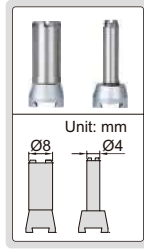

2399-08

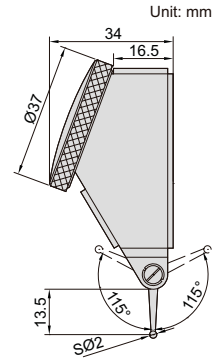

Code	Range	Graduation	Accuracy	Hysteresis	Dial reading
2399-08*	0.8mm	0.01mm	13 μm	3 μm	0-40-0

*Supplied with manufacturer inspection certificate traceable to NIST USA

LONG STYLUS DIAL TEST INDICATOR

INSPECTION CERTIFICATE
TRACEABLE TO NIST

JEWELLED BEARING

- Meet DIN2270
- Jeweled bearing
- Carbide contact point
- Two measuring directions
- Anti magnetic body
- Supplied with two clamps: diameter $\varnothing 4\text{mm}$ and $\varnothing 8\text{mm}$
- Optional accessory: styli (page 134)

clamp (included)

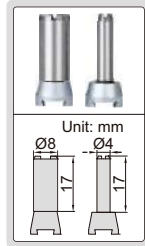

2383-08A

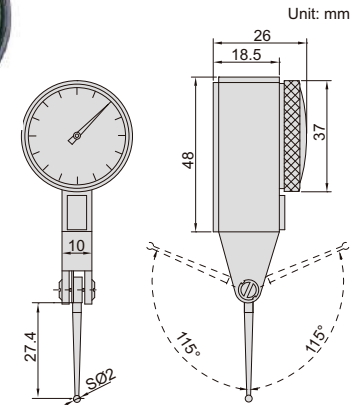

Code	Range	Graduation	Accuracy	Hysteresis	Dial reading
2383-08A*	0.8mm	0.01mm	13 μm	3 μm	0-40-0

*Supplied with manufacturer inspection certificate traceable to NIST USA

LARGE RANGE DIAL TEST INDICATOR

INSPECTION CERTIFICATE
TRACEABLE TO NIST

JEWELLED BEARING

- Dial reading: 0-40-0
- Jeweled bearing
- Carbide contact point
- Two measuring directions
- Anti magnetic body
- Supplied with two clamps: diameter $\varnothing 4\text{mm}$ and $\varnothing 8\text{mm}$
- Optional accessory: styli (page 134)

clamp (included)

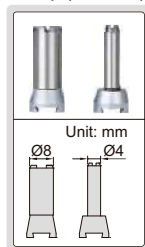

2386-16A

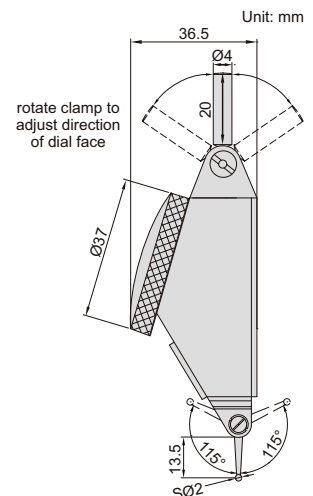

Code	Range	Graduation	Accuracy	Hysteresis
2386-16A*	1.6mm	0.01mm	25 μm	8 μm

*Supplied with manufacturer inspection certificate traceable to NIST USA

INSPECTION CERTIFICATE
TRACEABLE TO NIST

JEWELLED BEARING

LARGE RANGE BACK PLUNGER TYPE DIAL TEST INDICATOR

- Dial Reading: 0-40-0
- Jeweled bearing
- Carbide contact point
- Two measuring directions
- Anti magnetic body
- Supplied with two clamps: diameter Ø4mm and Ø8mm
- Optional accessory: styli (page 134)

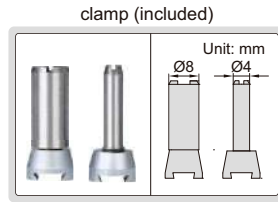

2480-16

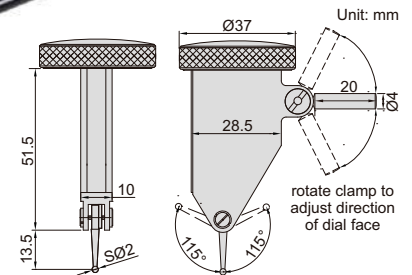

Code	Range	Graduation	Accuracy	Hysteresis
2480-16*	1.6mm	0.01mm	18µm	3µm

* Supplied with manufacturer inspection certificate traceable to NIST USA

INSPECTION CERTIFICATE
TRACEABLE TO NIST

JEWELLED BEARING

ROUND BODY DIAL TEST INDICATOR

- Meet DIN2270
- Jeweled bearing
- Carbide contact point
- Adjustable two measuring directions
- Anti magnetic body
- Supplied with two clamps: diameter Ø4mm and Ø8mm
- Optional accessory: styli (page 134)

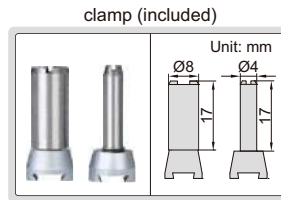

2391-08

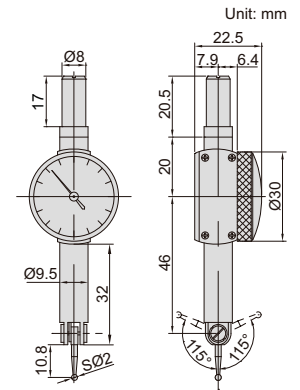

Code	Range	Graduation	Accuracy	Hysteresis	Dial reading
2391-08*	0.8mm	0.01mm	13µm	3µm	0-40-0

* Supplied with manufacturer inspection certificate traceable to NIST USA

CLAMPS FOR DIAL TEST INDICATORS

Code	ØD
6298-1	Ø4mm
6298-2	Ø8mm

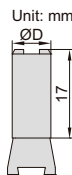

6298-1



6298-2

STYLI FOR DIAL TEST INDICATORS

Code	For dial test indicator	Material of contact point	(mm)	
			L	D
6284-1	2380-08,	steel	13.5	SØ1
6284-3	2398-08	carbide	13.5	SØ2
6284-4	2381-08,	ruby	13.5	SØ2
6284-8	2399-08	carbide	13.5	SØ3
6284-21		steel	12.5	SØ1
6284-22	2380-02	carbide	12.5	SØ2
6284-24	2381-02	ruby	12.5	SØ2
6284-23		carbide	12.5	SØ3
6284-44	2880-02	carbide	11.7	SØ0.4
6284-41	2880-02R	carbide	11.7	SØ1
6284-42	2895-08	carbide	11.7	SØ2
6284-45	2897-02	ruby	11.7	SØ2
6284-43	2898-08	carbide	11.7	SØ3

Code	For dial test indicator	Material of contact point	(mm)	
			L	D
6284-71	2391-08	carbide	10.8	SØ2
6284-51		carbide	34.6	SØ1
6284-52	2896-05	carbide	34.6	SØ2
6284-55	2899-05	ruby	34.6	SØ2
6284-53		carbide	34.6	SØ3
6284-61		steel	13.5	SØ1
6284-62	2386-16A	carbide	13.5	SØ2
6284-63	2480-16	ruby	13.5	SØ2
6284-64		carbide	13.5	SØ3
6284-81		steel	27.4	SØ1
6284-82	2383-08A	carbide	27.4	SØ2
6284-83		ruby	27.4	SØ2
6284-84		carbide	27.4	SØ3



6284-3

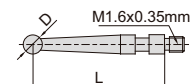

DIAL TEST INDICATOR UNIVERSAL HOLDER

- Set the indicators at the desired attitude to the workpiece



6297-1

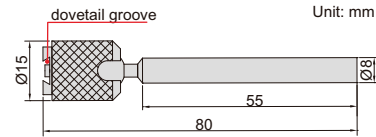

Code
6297-1

7 DIAL TEST INDICATOR HOLDER

- Supplied with hex key



6296-1

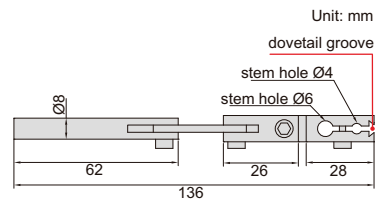

Code
6296-1

DIAL TEST INDICATOR HOLDERS



6293-1



6293-2

Code	Stem section	Stem length (L)
6293-1	9x9mm	100mm
6293-6	9x9mm	50mm
6293-2	Ø8mm	115mm

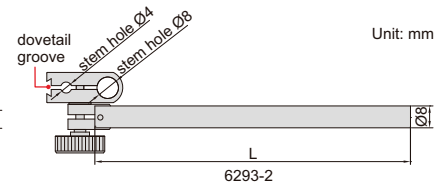
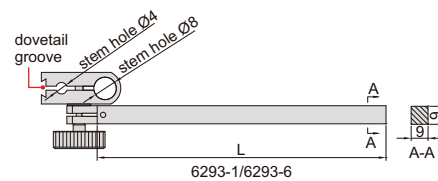

DIAL TEST INDICATOR CENTERING HOLDER

- Center cylinders or holes on machine tools

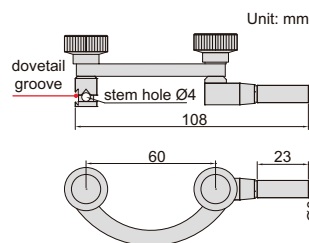

6291-1

Code
6291-1

ATTENTION: NOT SUITABLE FOR DIAL GAGES WITH GRADUATION 0.001MM

- To calibrate dial indicators, test indicators and dial bore gages
- Dimension: 270x210x205mm
- Weight: 11kg

Micrometer head

Range	Sampling interval	Accuracy	Hysteresis
0-25mm	0.1mm	4µm (0-25mm), 3µm (0-10mm), 2µm (0-1mm)	1µm

Force gage

Range	Graduation	Accuracy
0-1.6N	0.05N	±5% (of load capacity)

Stage

Diameter	Flatness	Roughness
50mm	1µm	0.05µm



**DIAL GAGE TESTER
CODE 2396-25A**

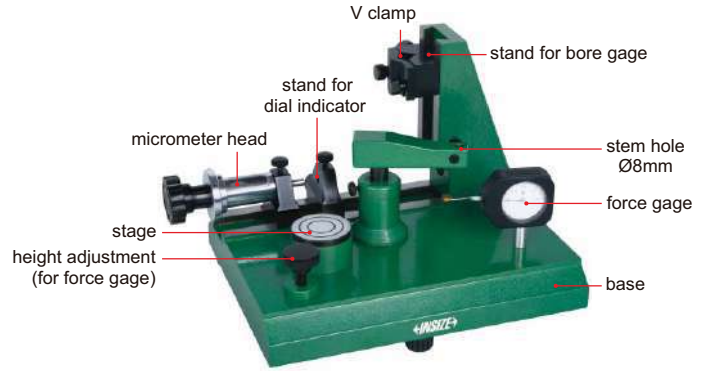

2396-25A



Half round gage block (optional)

Code	Parallelism
2396-block	1µm



ATTENTION: LOW LOCKING FORCE

UNIVERSAL MAGNETIC STAND (ECONOMIC TYPE)

- For digital/dial indicators and dial test indicators

Code	Magnetic force	Applicable holding stem	Remark
6208-80A	80kgf	Ø8mm	with fine adjustment and dovetail groove



6208-80A

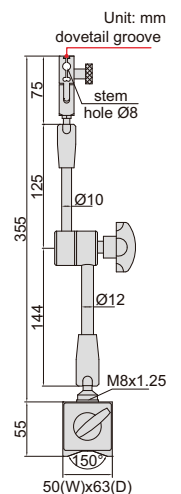

MAGNETIC STANDS

7

Unit: mm

6200-60
 stem hole Ø4
 stem hole 3/8" DIA. with bush Ø8
 176
 165
 Ø12
 M8X1.25
 55
 150°
 50(W)x60(D)
 6200-60

6201-60
 20° adjustable
 stem hole Ø4
 stem hole 3/8" DIA. with bush Ø8
 176
 150
 Ø12
 M8X1.25
 55
 150°
 50(W)x60(D)
 6201-60

6202-80
 20° adjustable
 stem hole Ø4
 stem hole 3/8" DIA. with bush Ø8
 225
 200
 Ø12
 M8X1.25
 55
 150°
 50(W)x60(D)
 6202-80

6202-100
 20° adjustable
 stem hole Ø4
 stem hole 3/8" DIA. with bush Ø8
 355
 220
 Ø12
 Ø20
 M10X1.25
 55
 150°
 50(W)x73(D)
 6202-100

- For digital/dial indicators and dial test indicators

Code	Magnetic force	Applicable holding stem	Remark
6200-60	60kgf	Ø8mm, Ø4mm, 3/8" DIA.	without fine adjustment
6201-60	60kgf	Ø8mm, Ø4mm, 3/8" DIA.	with fine adjustment
6202-80	80kgf	Ø8mm, Ø4mm, 3/8" DIA.	with fine adjustment
6202-100	100kgf	Ø8mm, Ø4mm, 3/8" DIA.	with fine adjustment

UNIVERSAL MAGNETIC STANDS

Unit: mm

6210-81
 dovetail groove
 stem hole Ø8
 255
 75
 71
 Ø9
 Ø10
 95
 M8x1.25
 55
 150°
 50(W)x60(D)
 6210-81

6210-80
 Unit: mm
 dovetail groove
 stem hole Ø8
 75
 110
 Ø10
 340
 135
 Ø12
 M8x1.25
 55
 150°
 50(W)x60(D)
 6210-80

6210-100
 Unit: mm
 dovetail groove
 stem hole Ø8
 75
 167
 Ø10
 488
 196
 Ø12
 M8x1.25
 55
 150°
 50(W)x75(D)
 6210-100

- For digital/dial indicators and dial test indicators

Code	Magnetic force	Applicable holding stem	Remark
6210-81	80kgf	Ø8mm	with fine adjustment and dovetail groove
6210-80	80kgf	Ø8mm	with fine adjustment and dovetail groove
6210-100	100kgf	Ø8mm	with fine adjustment and dovetail groove

MAGNETIC STAND WITH TWO FINE ADJUSTMENTS

- With two fine adjustments on the head and on the base
- For digital/dial indicators and dial test indicators

Code	Magnetic force	Applicable holding stem	Remark
6272-80	80kgf	Ø8mm	with two fine adjustments and dovetail groove

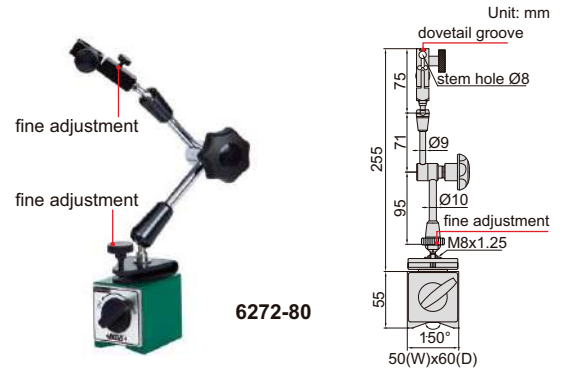

6272-80

7

MAGNETIC STAND FOR UNEVEN SURFACE

- For digital/dial indicators and dial test indicators
- With fine adjustment

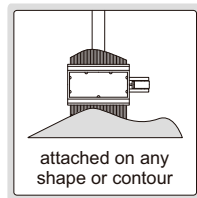

Code	Magnetic force	Applicable holding stem
6215-60	60kgf	Ø8mm, Ø4mm, 3/8" DIA.



6215-60

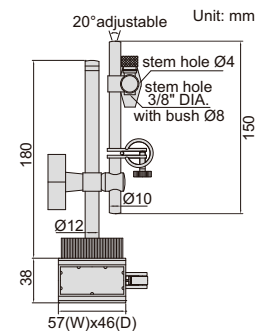

VACUUM STAND

- Suitable for granite surface plates or cast iron surface plates
- For digital/dial indicators and dial test indicators

Code	Diameter of vacuum disc	Vacuum force	Applicable holding stem	Remark
6217-B	Ø80mm	80kgf	Ø8mm	with fine adjustment and dovetail groove

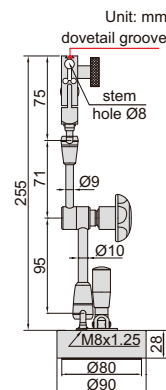

6217-B

UNIVERSAL STAND

- For digital/dial indicators and dial test indicators
- With fine adjustment

Code	Applicable holding stem
6214-A	Ø8mm, Ø4mm, 3/8" DIA.

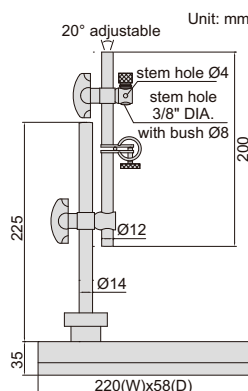

6214-A

FLEX ARM MAGNETIC STAND

ATTENTION: FOR DIAL TEST INDICATORS ONLY

- For dial test indicators



6207-80A

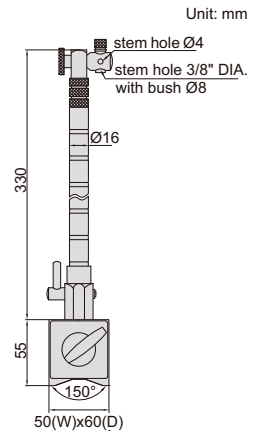

Code	Magnetic force	Applicable holding stem
6207-80A	80kgf	$\varnothing 8$ mm, $\varnothing 4$ mm, 3/8" DIA.

7

MINI MAGNETIC STAND

ATTENTION: FOR DIAL TEST INDICATORS ONLY

- For dial test indicators
- With fine adjustment and dovetail groove



6224-40

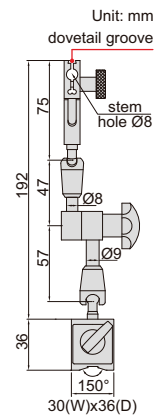

Code	Magnetic force	Applicable holding stem
6224-40	40kgf	$\varnothing 8$ mm

MINI MAGNETIC STAND

ATTENTION: FOR DIAL TEST INDICATORS ONLY

- For dial test indicators
- With dovetail groove



6211-10

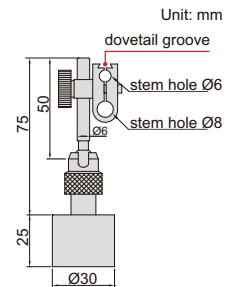

Code	Magnetic force	Applicable holding stem
6211-10	10kgf	$\varnothing 6$ mm, $\varnothing 8$ mm

MAGNETIC BASES



6212-80

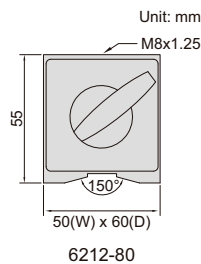

6212-100

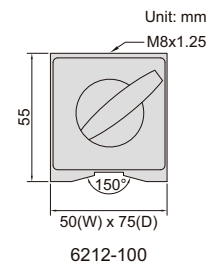

Code	Magnetic force
6212-80	80kgf
6212-100	100kgf

GRANITE DIAL INDICATOR STAND

- Vertical travel of holder: 150mm
- Fine adjustment range: 2mm
- Supplied with dust cover

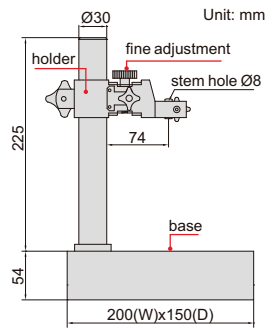

6866-150

7

Code	Applicable holding stem	Base
6866-150	Ø8mm	flatness 2.5µm

GRANITE DIAL INDICATOR STAND

- Vertical travel of holder: 250mm
- Fine adjustment range: entire stroke
- Supplied with dust cover

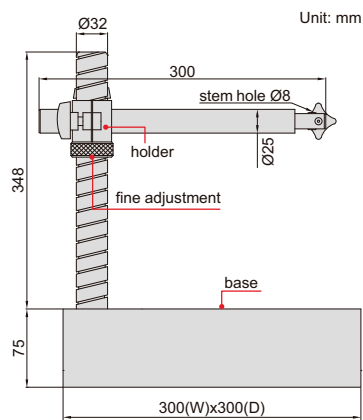

6867-250

Code	Applicable holding stem	Base
6867-250	Ø8mm	flatness 2.8µm

DIAL INDICATOR STAND

- Vertical travel of holder: 150mm
- Fine adjustment range: 2mm
- Supplied with dust cover

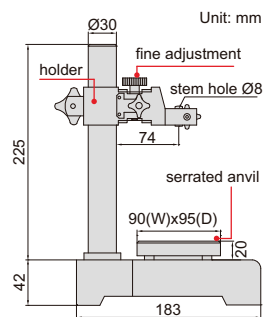

6863-150

Code	Applicable holding stem	Anvil
6863-150	Ø8mm	serrated, flatness 1.5µm, hardness HRC60±2

DIAL INDICATOR STAND

- Vertical travel of holder: 250mm
- Fine adjustment range: entire stroke
- Supplied with dust cover



6864-250

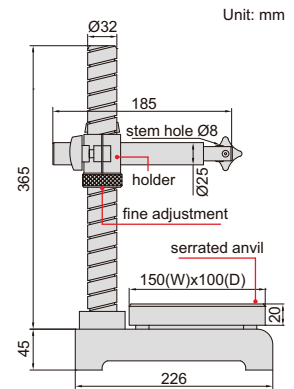

Code	Applicable holding stem	Anvil
6864-250	Ø8mm	serrated, flatness 1.5µm, hardness HRC60±2

7

DIAL INDICATOR STANDS

- Vertical travel of holder: 100mm
- Fine adjustment range: 2mm
- Supplied with dust cover

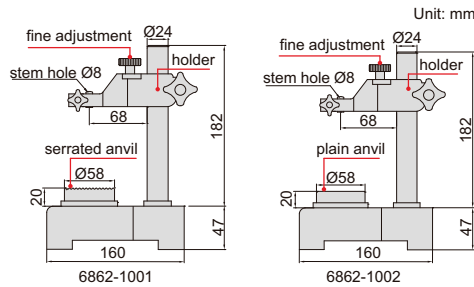

6862-1001



6862-1002

Code	Applicable holding stem	Anvil
6862-1001	Ø8mm	serrated, flatness 1.5µm, hardness HRC60±2
6862-1002	Ø8mm	plain, flatness 1.5µm, hardness HRC60±2

TRANSFER STAND

Application



Rigid construction, designed to make comparison height measurement (set zero with gage block then measure height of workpiece) with dial indicators or digital indicators (variation of measuring force is high)



6865-300

- Vertical travel of holder: 335mm
- Fine adjustment range: 2mm
- Supplied with dust cover

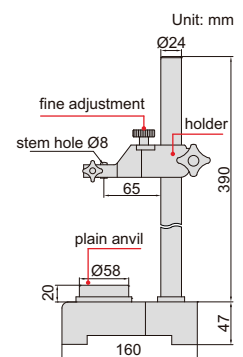

Code	Applicable holding stem	Anvil
6865-300	Ø8mm	plain, flatness 1.5µm, hardness HRC60±2

CONCENTRICITY GAGES

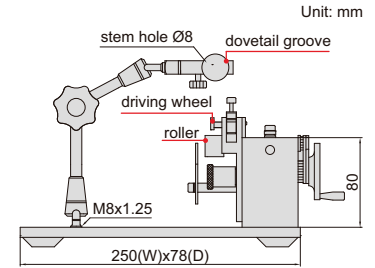
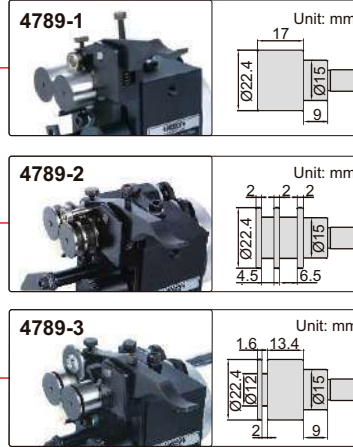

- Accuracy 2µm
- Optional accessory: dial test indicator, mini magnetic stand (code 6224-40)

Code	Applicable diameter
4789-1	Ø3.5mm-25mm
4789-2	Ø1mm-25mm
4789-3	Ø1mm-25mm

to ensure the accuracy 2µm, the distance between measuring point and roller should be <30mm

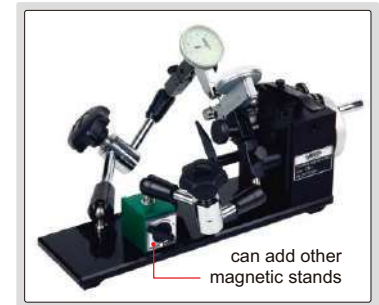
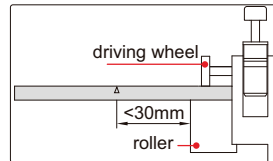

HIGH STABILITY, LONG WORKING LIFE

CONCENTRICITY GAGES



4725-45



4725-60



4725-80



to ensure the accuracy 2µm, the distance between measuring point and roller should be <30mm

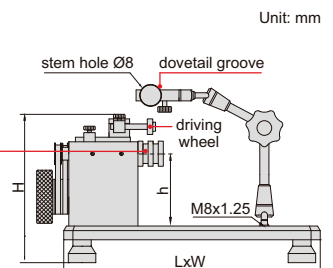
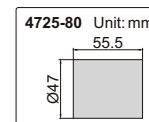
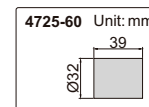
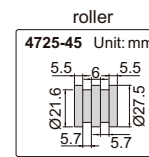
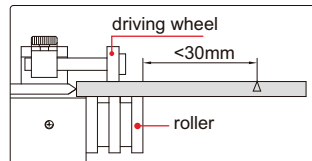

- With ball bearing, high stability, long working life
- Accuracy 2µm
- Optional accessory: dial test indicator

Code	Diameter range	Center height (h)	LxHxW	Weight
4725-45	3-45mm	80mm	280x130x170mm	6kg
4725-60	5-60mm	90mm	350x160x190mm	15.6kg
4725-80	8-80mm	130mm	400x200x250mm	25kg

CONCENTRICITY GAGES

QUICK-POSITIONING, SUITABLE FOR MASS MEASUREMENT

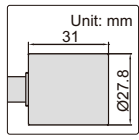

4726-1

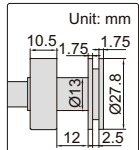

4726-2

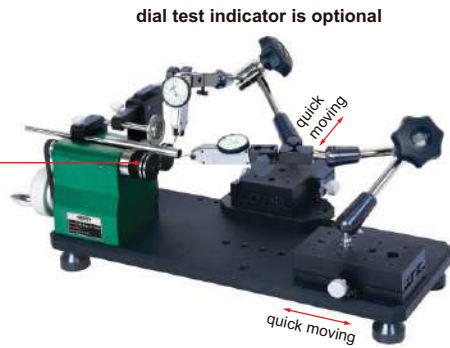

dial test indicator is optional

4726-2

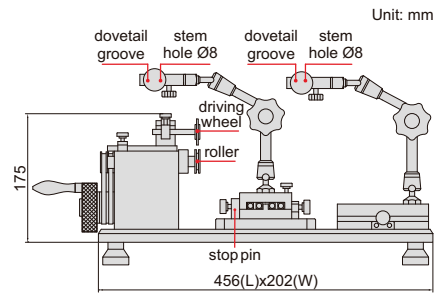

to ensure the accuracy 2µm, the distance between measuring point and roller should be <30mm

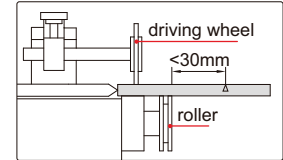

- With ball bearing, high stability, long working life
- Accuracy: 2µm
- Optional accessory: dial test indicator

Code	Applicable diameter
4726-1	Ø3-40mm
4726-2	Ø1-40mm

CONCENTRICITY GAGE

to ensure the accuracy 8µm, the distance between measuring point and roller should be <50mm

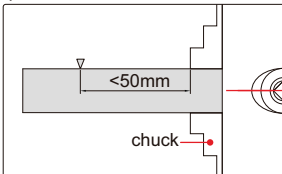

4786-1

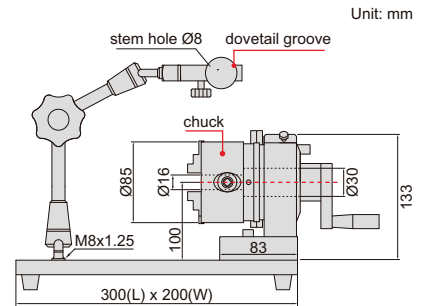

for cylinder

for tube



- Accuracy: 8µm
- Optional accessory: dial test indicator

Code	Applicable inside diameter	Applicable outside diameter
4786-1	Ø24-64mm	Ø2-70mm

VERTICAL AND HORIZONTAL BENCH CENTER

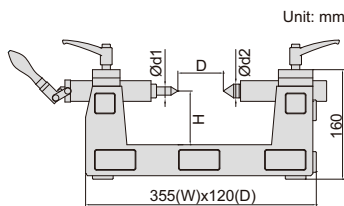

- For vertical, side and horizontal use



horizontal use



side use



vertical use

Code	Runout accuracy	Center height (H)	Distance between two centers (D)	Diameter of center (Ød1/Ød2)	Taper of center	Weight	Load
4722-200	2µm	80mm	200mm	12mm/20.2mm	MT1/MT3	22kg	25kg

BENCH CENTER WITH STRAIGHTNESS MEASUREMENT

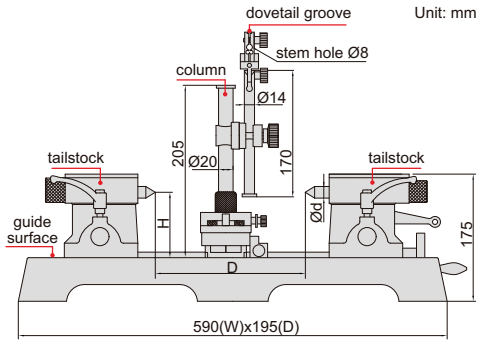

Unit: mm



straightness measurement

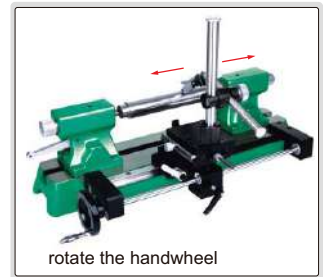

- Hardened cast-iron guide surface

4723-300

7

Code	Parallelism *	Runout accuracy	Accuracy of straightness measurement	Center height (H)	Distance between two centers (D)	Diameter of center (Ød)	Taper of center	Weight	Load
4723-300	4µm	2µm	0.02mm	90mm	300mm	18mm	MT2	38kg	25kg

* Parallelism of two centers to the guide surface

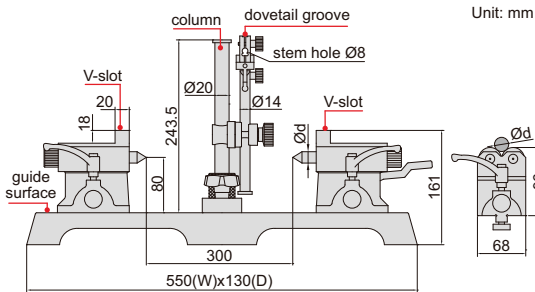

Unit: mm

BENCH CENTER WITH ROLLER TAILSTOCKS



roller tailstocks (included)



- Hardened cast-iron guide surface
- Supplied with V-slot/center tailstocks and roller tailstocks
- V-slot for cylinder Ø4~22mm
- Roller for cylinder Ø5~100mm

4720-300

Code	Parallelism *	Runout accuracy	Center height	Distance between two centers	Diameter of center (Ød)	Taper of center	Load
4720-300	0.01mm	2µm	80mm	300mm	16mm	MT1	25kg (40kg for roller tailstocks)

* Parallelism of two centers to the guide surface

BENCH CENTER (BASIC TYPE)

- Hardened cast-iron guide surface
- Movable column
- V-slot for cylinder Ø4~Ø22mm

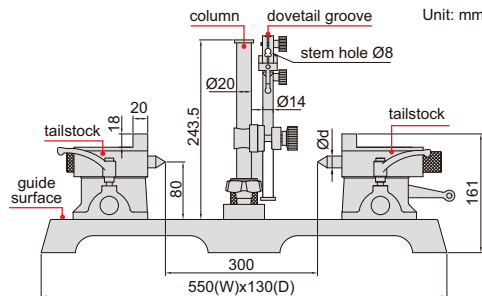

Unit: mm

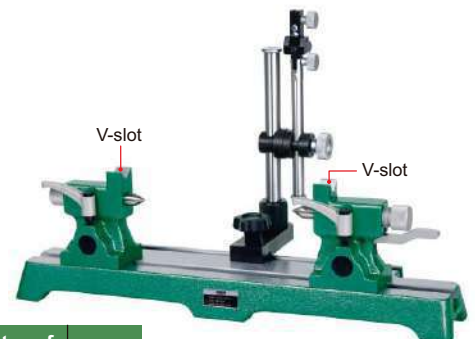

4782-300

Code	Parallelism *	Runout accuracy	Center height	Distance between two centers	Taper of center	Diameter of center (Ød)	Load
4782-300	0.01mm	2µm	80mm	300mm	MT1	Ø16mm	25kg

* Parallelism of two centers to the guide surface

MINI BENCH CENTER

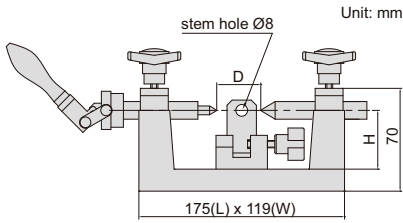

4721-75A

Code	Runout accuracy	Center height (H)	Distance between two centers (D)	Diameter of center (Ød)	Taper of center	Weight	Load
4721-75A	2µm	40mm	35-100mm	6mm	MT1	4.5kg	4kg

7

BENCH CENTERS

- Movable column
- Optional accessory: umbrella center, rotary center

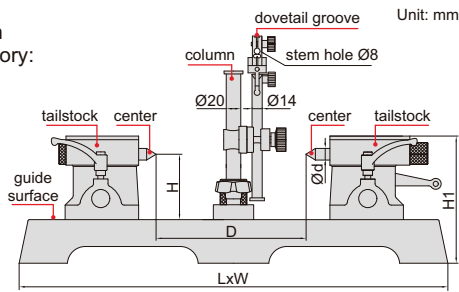

umbrella center (optional)



rotary center (optional)



4788-300

High accuracy

Code	Parallelism*	Runout accuracy	Center height (H)	Distance between two centers(D)	L	W	H1	Diameter of center (Ød)	Taper of center	Weight	Load
4788-300	0.010mm	2µm	90	300	590	192	175	18.0	MT2	34kg	25kg
4788-400	0.010mm	2µm	130	400	770	206	241	24.1	MT3	66kg	60kg
4788-600	0.010mm	2µm	130	600	930	220	250	24.1	MT3	90kg	60kg
4788-600H2	0.010mm	2µm	200	600	930	220	325	24.1	MT3	105kg	60kg
4788-1000	0.010mm	3µm	130	1000	1330	220	262	24.1	MT3	112kg	60kg
4788-1000H2	0.010mm	3µm	200	1000	1330	220	337	24.1	MT3	125kg	85kg
4788-1000H3	0.010mm	3µm	300	1000	1330	220	442	31.6	MT4	165kg	85kg

(mm)

Low accuracy

Code	Parallelism*	Runout accuracy	Center height (H)	Distance between two centers(D)	L	W	H1	Diameter of center (Ød)	Taper of center	Weight	Load
4788-D2	0.010mm	3µm	90	200	490	180	175	20.0	MT2	27kg	25kg
4788-D3	0.010mm	3µm	90	300	590	195	175	20.0	MT2	36kg	25kg
4788-D4	0.012mm	3µm	130	400	730	205	241	28.0	MT3	68kg	60kg
4788-D6	0.015mm	3µm	130	600	930	220	250	28.0	MT3	91kg	60kg
4788-D8	0.015mm	3µm	130	800	1130	220	250	28.0	MT3	99kg	60kg
4788-D10	0.015mm	3µm	130	1000	1330	220	262	28.0	MT3	116kg	60kg

(mm)

*Parallelism of two centers to the guide surface

TAPER INSPECTION INSTRUMENT

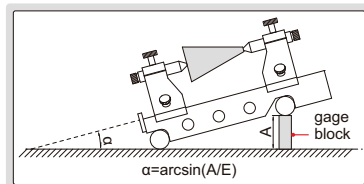

4157-200

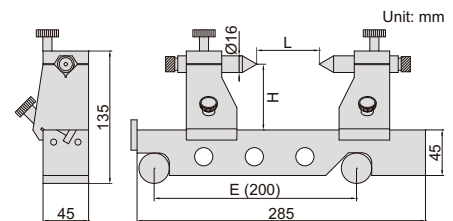

Code	Center height (H)	Center distance (L)
4157-200	65mm	200mm

DIGITAL INTERNAL CALIPER GAGES

- Resolution: 0.005mm/0.0002"
- Reading in digit and analog
- Display can be rotated by 170°
- Button function: tolerance Go and No-Go display, data preset, max./min. measurement, data holding, inch/metric conversion, absolute/incremental measurement
- CR2032 battery, automatic power off
- Data output



2121-15

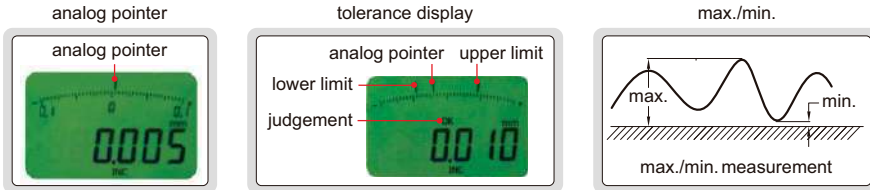

Code	Range	Accuracy	Repeatability	L	H	W	R
2121-15	5-15mm/0.2-0.6"	±0.03mm	0.01mm	20	2	1.5	R0.3
2121-25	5-25mm/0.2-1.0"	±0.03mm	0.01mm	35	1.5	1.0	R0.3
2121-31	10-30mm/0.4-1.2"	±0.03mm	0.01mm	55	5.5	2.5	R0.5
2121-41	20-40mm/0.8-1.6"	±0.03mm	0.01mm	80	6.0	3.0	R0.5
2121-51	30-50mm/1.2-2.0"	±0.03mm	0.01mm	80	8.0	3.0	R0.5
2121-61	40-60mm/1.6-2.4"	±0.03mm	0.01mm	80	8.0	3.0	R0.5

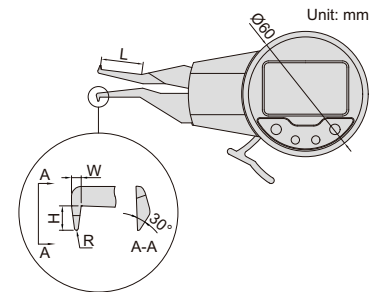

INTERNAL DIAL CALIPER GAGES

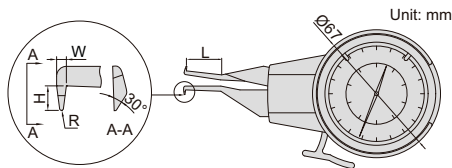

2222-15

Code	Range	Graduation	Accuracy	L	H	W	R
2222-15	5-15mm	0.01mm	±0.03mm	20	2	1.5	R0.3
2222-25	5-25mm	0.01mm	±0.03mm	35	1.5	1.0	R0.3
2222-301	10-30mm	0.01mm	±0.03mm	55	5.5	2.5	R0.5
2222-401	20-40mm	0.01mm	±0.03mm	80	6.0	3.0	R0.5
2222-501	30-50mm	0.01mm	±0.03mm	80	8.0	3.0	R0.5
2222-60	40-60mm	0.01mm	±0.03mm	80	8.0	3.0	R0.5

INTERNAL DIAL CALIPER GAGES

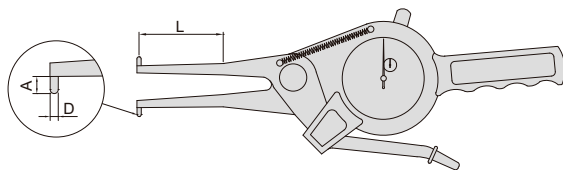

2321-35

Code	Range	Graduation	Accuracy	L	A	D
2321-35	15-35mm	0.01mm	±0.04mm	50	3	∅3
2321-AL35	15-35mm	0.01mm	±0.04mm	200	3	∅3
2321-55	35-55mm	0.01mm	±0.04mm	80	6	∅3
2321-AL55	35-55mm	0.01mm	±0.04mm	250	8	∅3
2321-75	55-75mm	0.01mm	±0.04mm	90	8	∅3
2321-AL75	55-75mm	0.01mm	±0.04mm	250	8	∅3
2321-95	75-95mm	0.01mm	±0.04mm	100	8	∅3
2321-115	95-115mm	0.01mm	±0.04mm	120	10	∅3.2
2321-135	115-135mm	0.01mm	±0.04mm	120	10	∅3.2

- Carbide measuring tips

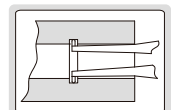

DIGITAL INTERNAL CALIPER GAGES

DATA OUTPUT

- Carbide measuring tips
- Reading in digit and analog
- Display can be rotated by 320°
- Button function: tolerance Go and No-Go display, data preset, measuring direction change, max./min./TIR measurement, inch/metric conversion, absolute/incremental measurement
- CR2032 battery, automatic power off
- Data output
- Optional accessory: data output cable (code 7315-, 7302-, 7305-)



2151-35

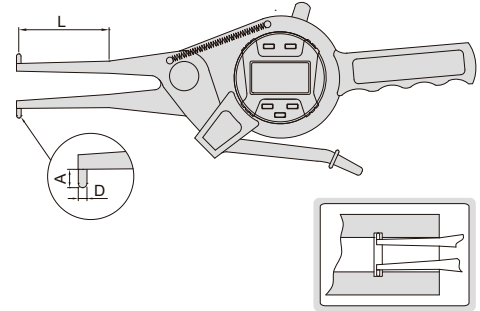

Code	Range	Resolution	Accuracy	L	A	D
2151-35	15-35mm/0.6-1.4"	0.01mm/0.0005"	±0.04mm	50	3	∅3
2151-AL35	15-35mm/0.6-1.4"	0.01mm/0.0005"	±0.04mm	200	3	∅3
2151-55	35-55mm/1.4-2.2"	0.01mm/0.0005"	±0.04mm	80	6	∅3
2151-AL55	35-55mm/1.4-2.2"	0.01mm/0.0005"	±0.04mm	250	8	∅3
2151-75	55-75mm/2.2-3"	0.01mm/0.0005"	±0.04mm	90	8	∅3
2151-AL75	55-75mm/2.2-3"	0.01mm/0.0005"	±0.04mm	250	8	∅3
2151-95	75-95mm/3-3.8"	0.01mm/0.0005"	±0.04mm	100	8	∅3
2151-115	95-115mm/3.8-4.6"	0.01mm/0.0005"	±0.04mm	120	10	∅3.2
2151-135	115-135mm/4.6-5.4"	0.01mm/0.0005"	±0.04mm	120	10	∅3.2

8

DIGITAL EXTERNAL CALIPER GAGES

- Resolution: 0.005mm/0.0002"
- Reading in digit and analog
- Display can be rotated by 170°
- Button function: tolerance Go and No-Go display, data preset, max./min. measurement, data holding, inch/metric conversion, absolute/incremental measurement
- CR2032 battery, automatic power off
- Data output



2131-21

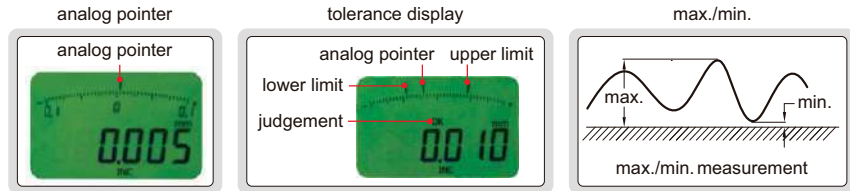
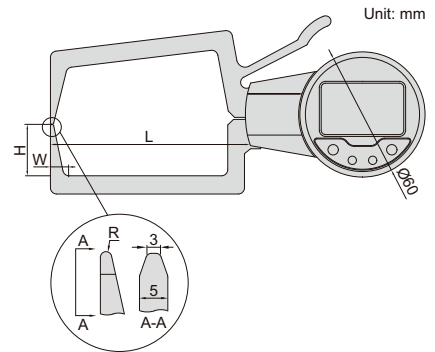

Code	Range	Accuracy	Repeatability	L	H	W	R
2131-21	0-20mm/0-0.8"	±0.03mm	0.01mm	80mm	25mm	6.5mm	R0.5mm
2131-31	10-30mm/0.4-1.2"	±0.03mm	0.01mm	80mm	25mm	6.5mm	R0.5mm
2131-41	20-40mm/0.8-1.6"	±0.03mm	0.01mm	80mm	25mm	6.5mm	R0.5mm
2131-51	30-50mm/1.2-2.0"	±0.03mm	0.01mm	80mm	25mm	6.5mm	R0.5mm
2131-61	40-60mm/1.6-2.4"	±0.03mm	0.01mm	80mm	25mm	6.5mm	R0.5mm

EXTERNAL DIAL CALIPER GAGES



2333-201

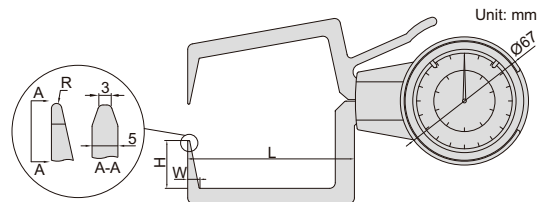

Code	Range	Graduation	Accuracy	L	H	W	R
2333-201	0-20mm	0.01mm	±0.03mm	80	25	6.5	R0.5
2333-301	10-30mm	0.01mm	±0.03mm	80	25	6.5	R0.5
2333-401	20-40mm	0.01mm	±0.03mm	80	25	6.5	R0.5
2333-501	30-50mm	0.01mm	±0.03mm	80	25	6.5	R0.5
2333-601	40-60mm	0.01mm	±0.03mm	80	25	6.5	R0.5

EXTERNAL DIAL CALIPER GAGES

- Carbide measuring tips

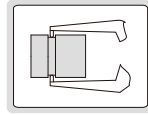

2332-20

Unit: mm

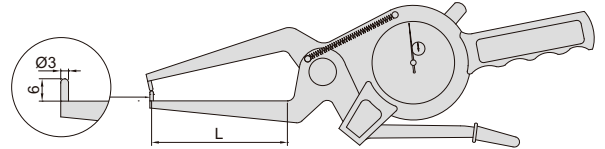

Code	Range	Graduation	Accuracy	L (mm)
2332-20	0-20mm	0.01mm	±0.04mm	60
2332-40	20-40mm	0.01mm	±0.04mm	60
2332-60	40-60mm	0.01mm	±0.04mm	55
2332-80	60-80mm	0.01mm	±0.04mm	55
2332-100	80-100mm	0.01mm	±0.04mm	55

DATA OUTPUT

- Carbide measuring tips
- Reading in digit and analog
- Display can be rotated by 320°
- Button function: tolerance Go and No-Go display, data preset, measuring direction change, max./min./TIR measurement, inch/metric conversion, absolute/incremental measurement
- CR2032 battery, automatic power off
- Data output
- Optional accessory: data output cable (code 7315-, 7302-, 7305-)

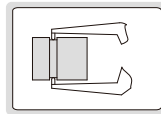

DIGITAL EXTERNAL CALIPER GAGES



2132-20

Unit: mm

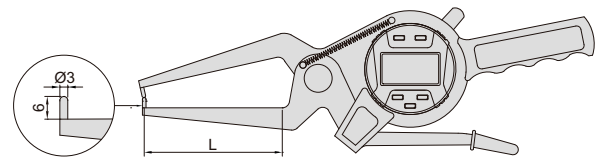

Code	Range	Resolution	Accuracy	L (mm)
2132-20	0-20mm/0-0.8"	0.01mm/0.0005"	±0.04mm	60
2132-40	20-40mm/0.8-1.6"	0.01mm/0.0005"	±0.04mm	60
2132-60	40-60mm/1.6-2.4"	0.01mm/0.0005"	±0.04mm	55
2132-80	60-80mm/2.4-3.2"	0.01mm/0.0005"	±0.04mm	55
2132-100	80-100mm/3.2-4"	0.01mm/0.0005"	±0.04mm	55

DATA OUTPUT

- Ceramic spindle tip and anvil
- Buttons: on/off, zero, mm/inch
- Battery CR2032, automatic power off
- Data output
- Optional accessory: data output cable (code 7315-, 7302-, 7305-)

DIGITAL THICKNESS GAGES



2871-101

Unit: mm

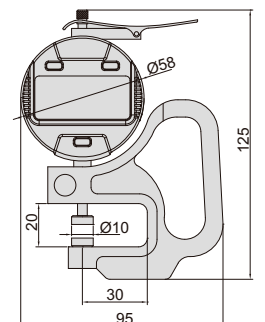

Code	Range	Resolution	Accuracy
2871-10	0-10mm/0-0.4"	0.01mm/0.0005"	±0.02mm
2871-101	0-10mm/0-0.4"	0.001mm/0.00005"	±0.005mm

THICKNESS GAGES

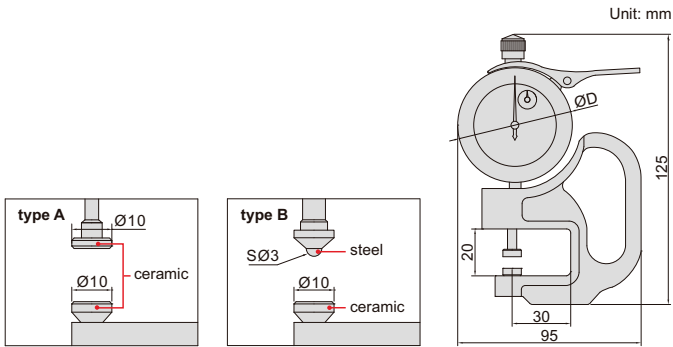

Code	Range	Graduation	Accuracy	Type	ØD
2364-10	0-10mm	0.01mm	±0.02mm	A	58mm
2364-10B	0-10mm	0.01mm	±0.02mm	B	58mm
2364-1	0-1mm	0.001mm	±0.005mm	A	56mm



2364-10

2364-1

8

THICKNESS GAGES

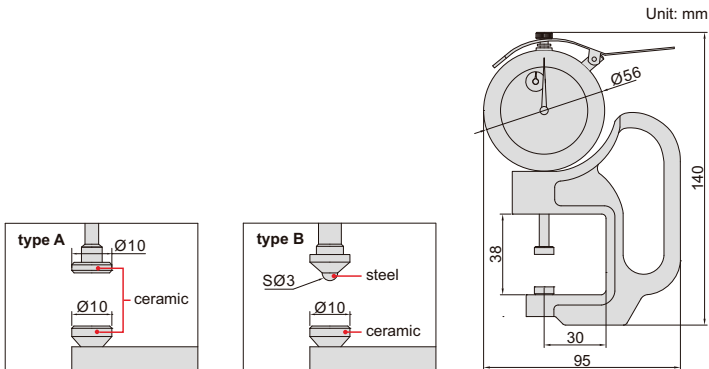

Code	Range	Graduation	Accuracy	Type
2366-30	0-30mm	0.01mm	±0.035mm	A
2366-30B	0-30mm	0.01mm	±0.035mm	B



2366-30

DIGITAL THICKNESS GAGE

DATA OUTPUT

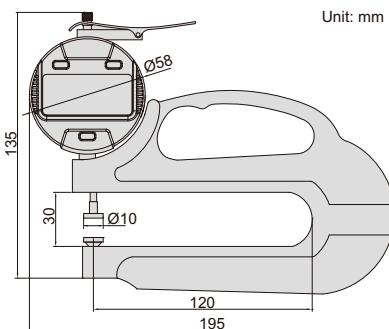

2872-10

- Ceramic spindle tip and anvil
- Buttons: on/off, zero, mm/inch
- Battery CR2032, automatic power off
- Data output
- Optional accessory: data output cable (code 7315-, 7302-, 7305-)

Code	Range	Resolution	Accuracy
2872-10	0-10mm/0-0.4"	0.01mm/0.0005"	±0.02mm

THICKNESS GAGES

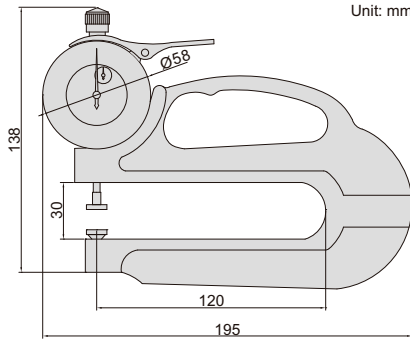
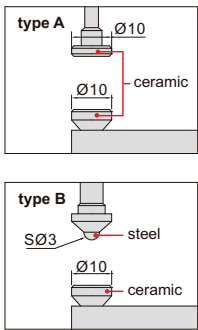

Unit: mm



2365-10

Code	Range	Graduation	Accuracy	Type
2365-10	0-10mm	0.01mm	±0.02mm	A
2365-20	0-20mm	0.01mm	±0.03mm	A
2365-10B	0-10mm	0.01mm	±0.02mm	B
2365-20B	0-20mm	0.01mm	±0.03mm	B

THICKNESS GAGE

INSIZE PLUS
MADE IN GERMANY

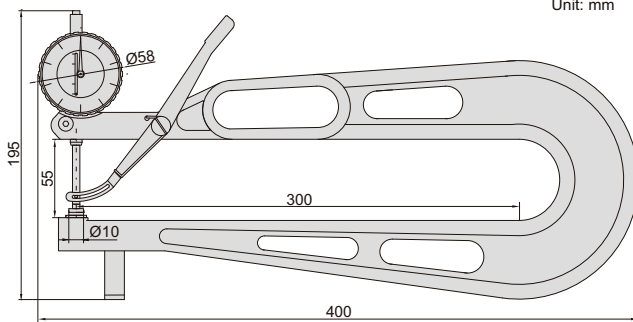

Unit: mm



2875-30

Code	Range	Graduation	Accuracy
2875-30	0-30mm	0.1mm	±0.05mm

DATA OUTPUT

measure wall thickness of grooves

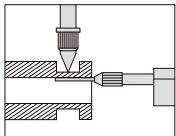

- Buttons: on/off, zero, mm/inch
- Battery CR2032, automatic power off
- Data output
- Optional accessory: data output cable (code 7315-, 7302-, 7305-)

Code	Range	Resolution	Accuracy
2873-10	0-10mm/0-0.4"	0.01mm/0.0005"	±0.02mm

DIGITAL TUBE THICKNESS GAGE



2873-10

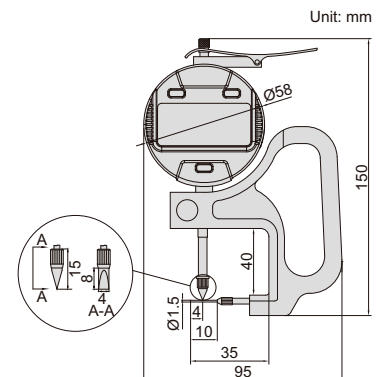

Unit: mm

DIGITAL TUBE THICKNESS GAGE

DATA
OUTPUT

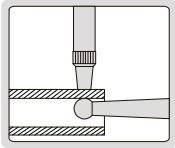

- Buttons: on/off, zero, mm/inch
- Battery CR2032, automatic power off
- Data output
- Optional accessory: data output cable (code 7315-, 7302-, 7305-)

Code	Range	Resolution	Accuracy
2876-10	0-10mm/0-0.4"	0.01mm/0.0005"	±0.02mm



2876-10

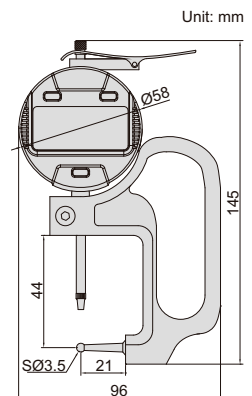

8

TUBE THICKNESS GAGE

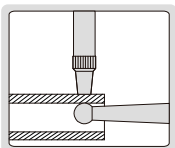

- Measure tube wall thickness

Code	Range	Graduation	Accuracy
2367-10A	0-10mm	0.01mm	±0.02mm



2367-10A

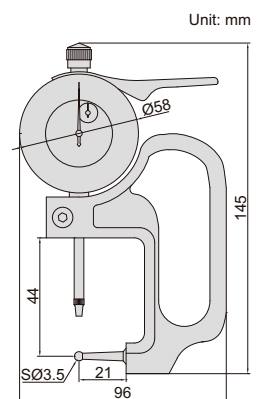

THICKNESS GAGE

SUITABLE FOR
JEWELLERY

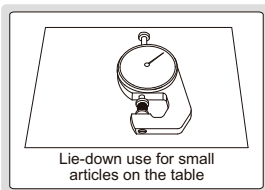

Code	Range	Graduation	Accuracy
2361-10	0-10mm	0.1mm	±0.05mm



2361-10

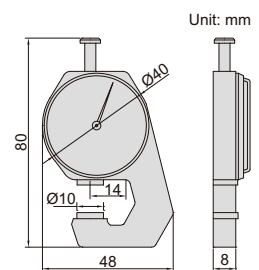

THICKNESS GAGE

- Stainless steel spindle tip and anvil

Code	Range	Graduation	Accuracy
2363-10	0-10mm	0.01mm	±0.03mm



2363-10

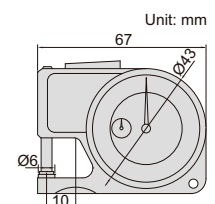

THICKNESS GAGES

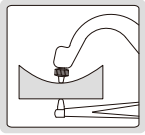

Code	Range	Graduation	Accuracy	L	L1
2862-101	0-10mm	0.05mm	±0.1mm	35	85
2862-102	0-10mm	0.05mm	±0.1mm	60	110



2862-101

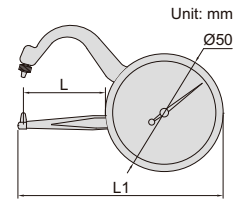

THICKNESS GAGE

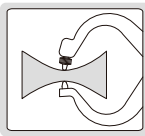

Code	Range	Graduation	Accuracy
2863-10	0-10mm	0.05mm	±0.1mm



2863-10

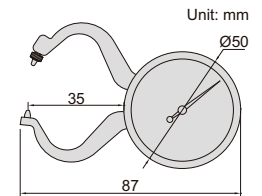

THICKNESS GAGE WITH POINTED TIPS

- Pointed tips fit into small grooves and recesses

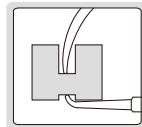

Code	Range	Graduation	Accuracy
2866-10	0-10mm	0.05mm	±0.1mm

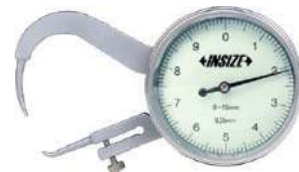

2866-10

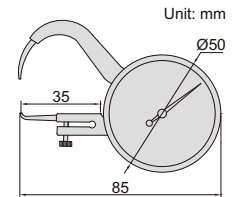

IP54
WATERPROOF

- Quick Go/No-Go measurement for mass production
- Anvil retracting stroke: 2.5mm
- Dial indicator: measuring range ±0.07mm, graduation 1µm, accuracy ±1µm
- Constant measuring force over the whole range: 8.5N
- Carbide measuring faces
- IP54 dust/waterproof
- Zero position of dial indicator is adjustable and can be locked (supplied with locking wrench)
- Adjustable platform height

DIAL SNAP GAGES

INSIZE PLUS
MADE IN GERMANY

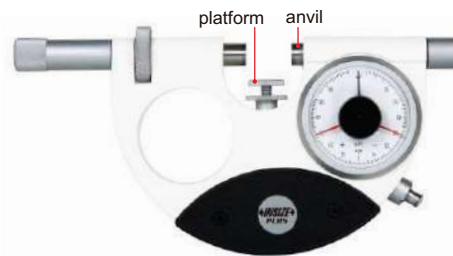

3335-25

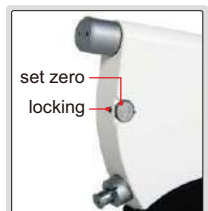
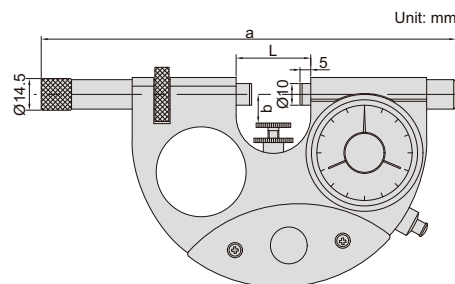

Code	Range	L	a	b
3335-25	0-25mm	35	191	<15
3335-50	25-50mm	60	215	<25
3335-75	50-75mm	84	239	<37.5
3335-100	75-100mm	110	265	<50

DIAL SNAP GAGES

QUICK AND ACCURATE MEASUREMENT OF CYLINDRICAL WORKPIECES

INSPECTION CERTIFICATE
TRACEABLE TO DKD

- Left anvil retracting stroke: 2mm
- Measuring force: 6-8N
- Flatness of anvil: 1.5µm
- Repeatability: 1µm
- Carbide measuring faces for anvils
- Front edges of anvils are chamfered for easy workpiece insertion
- Optional accessory: dial indicators and digital indicators (reading 0.001mm or 0.01mm)



2186-25

Code	Range	Parallelism of measuring faces	(mm)		
			A	B	C
2186-25 *	0-25mm	4µm	42	11-18	20
2186-50 *	25-50mm	4µm	69	11-32	41
2186-75 *	50-75mm	5µm	94	17-41	51
2186-100 *	75-100mm	6µm	119	31-55	65
2186-125 *	100-125mm	6µm	144	42-70	75
2186-150 *	125-150mm	8µm	169	55-82	90
2186-175 *	150-175mm	8µm	194	68-95	100
2186-200 *	175-200mm	10µm	219	85-110	115
2186-225 *	200-225mm	10µm	244	95-120	130
2186-250 *	225-250mm	10µm	269	110-135	145
2186-275 *	250-275mm	12µm	294	120-150	160
2186-300 *	275-300mm	12µm	319	128-160	170

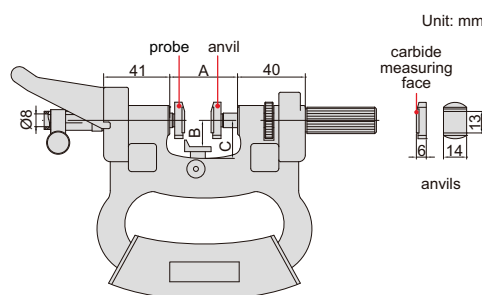

* Supplied with manufacturer inspection certificate traceable to DKD Germany

DIAL SNAP GAGES

ATTENTION: NOT SUITABLE FOR 0.001MM INDICATORS



- Quick measurement for mass production
- Anvil retracting stroke: 3mm
- Measuring force: 6-9N
- Carbide measuring faces
- Optional accessory: dial indicators (graduation 0.01mm), digital indicators (resolution 0.01mm/0.0005")

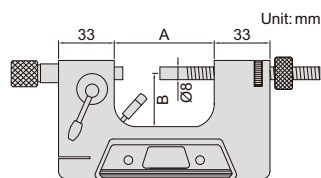

2184-50W

Code	Range	A	B
2184-25W	0-25mm	34mm	18mm
2184-50W	0-50mm	62mm	32mm
2184-100W	50-100mm	112mm	62mm
2184-150W	100-150mm	162mm	85mm
2184-200W	150-200mm	212mm	110mm

DIAL SNAP GAGES (ECONOMIC TYPE)

IP54 WATERPROOF

ATTENTION: SETTING STANDARDS ARE NOT INCLUDED

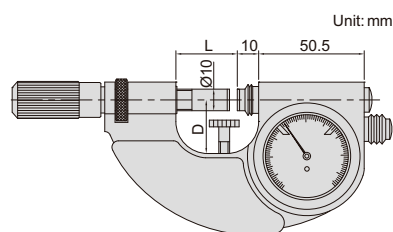

3334-25

- Quick measurement for mass production
- Dial indicator: range ±0.04mm, graduation 0.001mm, accuracy 0.001mm
- IP54 dust/waterproof
- Measuring force: 5-10N
- Carbide measuring faces
- Optional accessory: gage blocks grade 0 (4101-A series), for zero setting

Code	Range	L	D
3334-25	0-25mm	28.5mm	25mm
3334-50	25-50mm	53.5mm	35mm
3334-75	50-75mm	78.5mm	47.5mm
3334-100	75-100mm	103.5mm	60mm

FAST AND ACCURATE MEASUREMENT FOR CYLINDERS

ADJUSTABLE SNAP GAGES

- Used as Go/No-Go gage by setting upper and lower limits
- Flatness of anvil: 1.5µm
- Parallelism of measuring faces:
 - range 0-32mm: 3µm
 - range 32-89mm: 4µm
 - range 89-300mm: 5µm



2187-6

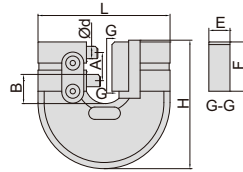

0-6mm



2187-19

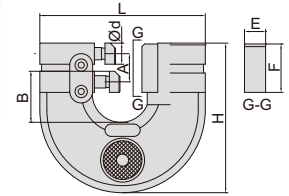

over 6mm

Code	Range	L	A	B	E	F	H	Ød
2187-6	0-6mm	74	15	17.5	12.2	27.2	71.5	7
2187-13	6-13mm	85	15	26	12.2	27.2	79.5	12.3
2187-19	13-19mm	93	15	27	12.2	27.2	83	12.3
2187-25	19-25mm	100	15	33.5	12.2	27.2	89.5	12.3
2187-32	25-32mm	111	18	38.5	15.2	35.2	104	15.3
2187-38	32-38mm	117	18	41.5	15.2	35.2	105	15.3
2187-44	38-44mm	123	18	44.5	15.2	35.2	109	15.3
2187-51	44-51mm	130	18	48	15.2	35.2	117	15.3
2187-57	51-57mm	136	18	45	15.2	35.2	119	15.3
2187-63	57-63mm	143	18	50	15.2	35.2	122	15.3
2187-70	63-70mm	156	20	58	15.2	35.2	132	15.3
2187-76	70-76mm	163	20	60.5	15.2	35.2	137	15.3
2187-82	76-82mm	169	20	64.5	15.2	35.2	140	15.3
2187-89	82-89mm	175	20	66.5	15.2	35.2	146	15.3
2187-95	89-95mm	181	20	69.5	15.2	35.2	149	15.3
2187-101	95-101mm	188	20	70	15.2	35.2	154	15.3
2187-108	101-108mm	198	24	79	15.2	39.2	166	15.3
2187-114	108-114mm	204	24	81	15.2	39.2	172	15.3

Code	Range	L	A	B	E	F	H	Ød
2187-120	114-120mm	210	24	86	15.2	39.2	179	15.3
2187-127	120-127mm	217	24	89.5	15.2	39.2	186	15.3
2187-133	127-133mm	223	24	92.5	15.2	39.2	192	15.3
2187-139	133-139mm	229	24	95.5	15.2	39.2	197	15.3
2187-146	139-146mm	235	24	98.5	15.2	39.2	201	15.3
2187-152	146-152mm	242	24	102	15.2	39.2	205	15.3
2187-163	152-163mm	273	21.4	106.7	18.2	39.2	211	18.3
2187-175	163-175mm	273	21.4	106.7	18.2	39.2	211	18.3
2187-188	175-188mm	298.5	21.4	119.7	18.2	39.2	227	18.3
2187-200	188-200mm	298.5	21.4	119.7	18.2	39.2	227	18.3
2187-213	200-213mm	324	21.4	131.7	18.2	39.2	242	18.3
2187-225	213-225mm	324	21.4	131.7	18.2	39.2	242	18.3
2187-238	225-238mm	349.5	21.4	144.7	18.2	39.2	250	18.3
2187-250	238-250mm	349.5	21.4	149	18.2	39.2	250	18.3
2187-263	250-263mm	375.5	21.4	157.7	18.2	39.2	278	18.3
2187-275	263-275mm	375.5	21.4	157.7	18.2	39.2	278	18.3
2187-288	275-288mm	400	21.4	170.7	18.2	39.2	291	18.3
2187-300	288-300mm	400	21.4	170.7	18.2	39.2	291	18.3

DIGITAL SNAP GAGE



2166-12

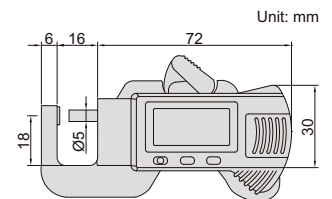

Code	Range	Resolution	Accuracy
2166-12	0-12mm/0-0.5"	0.01mm/0.0005"	±0.03mm

ATTENTION: NO DATA OUTPUT

DIGITAL SNAP GAGE



2167-25

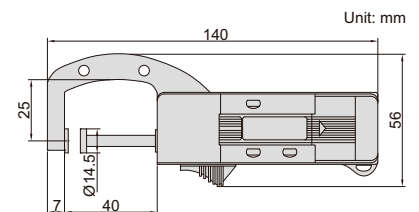

Code	Range	Resolution	Accuracy
2167-25	0-25mm/0-1"	0.01mm/0.0005"	±0.03mm

DIGITAL SNAP GAGE



2163-25

- Resolution: 0.01mm/0.0005"
- Accuracy: ± 0.04 mm
- For thickness and tube wall thickness measurement

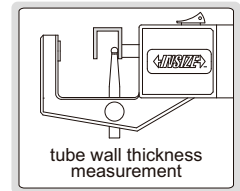
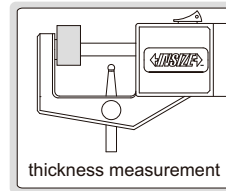
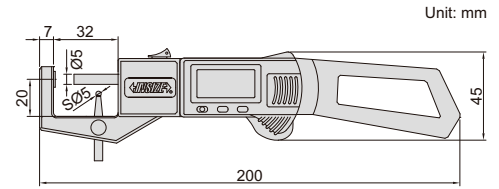

8

Code	Thickness range	Tube wall thickness range
2163-25	0-25mm/0-1"	0-2mm/0.08"

DIGITAL SNAP GAGES

DATA OUTPUT



1163-50A

- Buttons: on/off, zero, mm/inch
- Automatic power off, move the digital unit to turn on power
- Battery CR2032
- Data output
- Made of stainless steel
- Optional accessory: data output cable (code 7315-, 7302-, 7305-, for snap gages without built-in wireless)

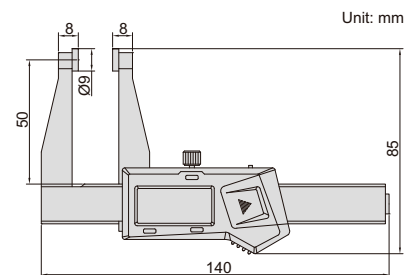

Code	Range	Resolution	Accuracy	Wireless
1163-50A	0-50mm/0-2"	0.01mm/0.0005"	± 0.03 mm	no
1163-50AWL				built-in wireless

DIGITAL 3-PURPOSE SNAP GAGE

ATTENTION: NO DATA OUTPUT

SUITABLE FOR JEWELLERY

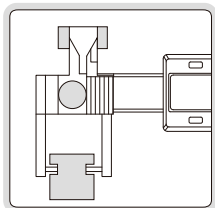

2164-25A

- Buttons: zero, mm/inch, on/off
- Battery LR44
- Made of stainless steel

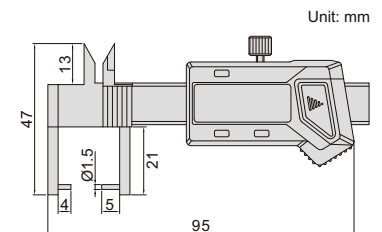

Code	Range	Resolution	Accuracy
2164-25A	0-25mm/0-1"	0.01mm/0.0005"	± 0.03 mm

DATA
OUTPUT

STEP AND GAP GAGES

- Measure step height and gap width
- Resolution: 0.01mm/0.0005"
- Buttons: on/off, zero, mm/inch
- Automatic power off, move the digital unit to turn on power
- Battery CR2032
- Data output
- Made of stainless steel
- Supplied with zero setting block
- Optional accessory: data output cable (code 7315-, 7302-, 7305-, for snap gages without built-in wireless)



front

2168-12

back

zero setting block
(included)

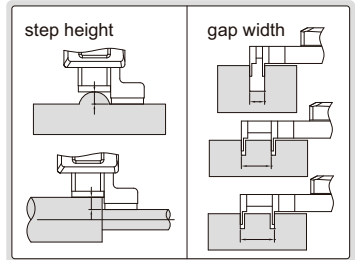
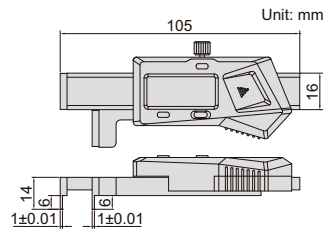

Code	Range	Accuracy	Wireless
2168-12	0-12.7mm/0-0.5"	±0.03mm	no
2168-12WL			built-in wireless

8

CRANKSHAFT TESTERS

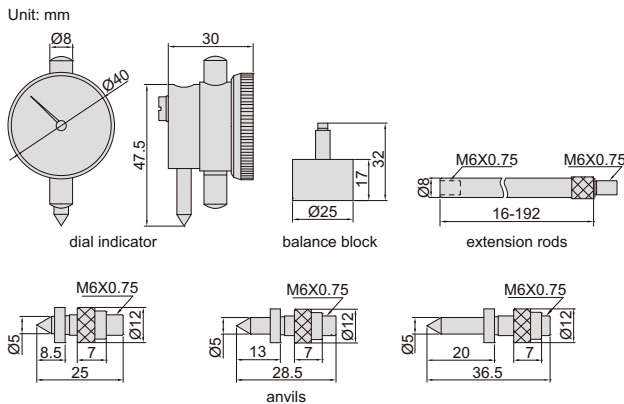

dial indicator

balance block

extension rods

anvils



2841-500

- To test crankshaft deflection
- The balance block is mounted on the back of dial indicator to keep the dial indicator facing up

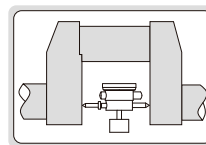

Code	Range	Dial indicator range	Graduation	Extension rods	Accuracy
2841-300	60-300mm	3mm	0.01mm	16mm, 32mm, 64mm, 128mm	±0.016mm
2841-500	60-500mm	3mm	0.01mm	16mm, 32mm, 64mm, 96mm, 128mm, 192mm	±0.016mm

SAW TEETH SETTING GAGE

INSIZE PLUS
MADE IN GERMANY



front

back

2874-02

- Supplied with limit pointer
- Read from both sides

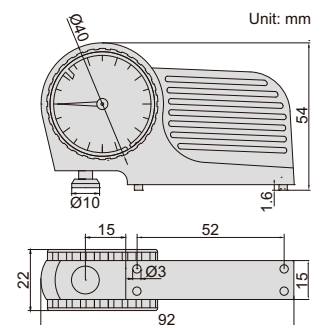

Code	Range	Graduation	Accuracy
2874-02	0-2mm	0.05mm	±0.05mm

GAGE BLOCKS

Accuracy according to ISO3650

Nominal length (mm)	Grade 0		Grade 1		Grade 2	
	Limit deviation of length	Tolerance for the variation in length	Limit deviation of length	Tolerance for the variation in length	Limit deviation of length	Tolerance for the variation in length
over 0.5 to 10	±0.12µm	0.10µm	±0.20µm	0.16µm	±0.45µm	0.30µm
over 10 to 25	±0.14µm	0.10µm	±0.30µm	0.16µm	±0.60µm	0.30µm
over 25 to 50	±0.20µm	0.10µm	±0.40µm	0.18µm	±0.80µm	0.30µm
over 50 to 75	±0.25µm	0.12µm	±0.50µm	0.18µm	±1.00µm	0.35µm
over 75 to 100	±0.30µm	0.12µm	±0.60µm	0.20µm	±1.20µm	0.35µm
over 100 to 150	±0.40µm	0.14µm	±0.80µm	0.20µm	±1.60µm	0.40µm
over 150 to 200	±0.50µm	0.16µm	±1.00µm	0.25µm	±2.00µm	0.40µm
over 200 to 250	±0.60µm	0.16µm	±1.20µm	0.25µm	±2.40µm	0.45µm
over 250 to 300	±0.70µm	0.18µm	±1.40µm	0.25µm	±2.80µm	0.50µm
over 300 to 400	±0.90µm	0.20µm	±1.80µm	0.30µm	±3.60µm	0.50µm
over 400 to 500	±1.10µm	0.25µm	±2.20µm	0.35µm	±4.40µm	0.60µm
over 500 to 600	±1.30µm	0.25µm	±2.60µm	0.40µm	±5.00µm	0.70µm
over 600 to 700	±1.50µm	0.30µm	±3.00µm	0.45µm	±6.00µm	0.70µm
over 700 to 800	±1.70µm	0.30µm	±3.40µm	0.50µm	±6.50µm	0.80µm
over 800 to 900	±1.90µm	0.35µm	±3.80µm	0.50µm	±7.50µm	0.90µm
over 900 to 1000	±2.00µm	0.40µm	±4.20µm	0.60µm	±8.00µm	1.00µm

Grade and application

Grade	Application
0	To be used as basic standards in calibration laboratories by skilled inspection staff, to calibrate or set high accuracy measuring instruments, to calibrate gage blocks of grade 1 and 2.
1	To be used in inspection rooms, to check gages, inspect high accuracy parts and set measuring instruments.
2	To be used in workshops, to check production gages, set measuring instruments and mount tools.

WEAR BLOCK SETS



- Protect the measuring surfaces of gage blocks from excessive wear
- Meet ISO3650
- Supplied with manufacturer inspection certificate



4111-2

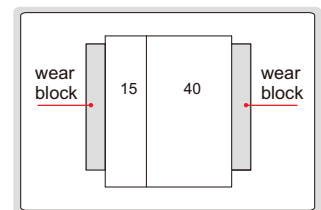

Blocks per set	Size	Material	Code	
			Grade 0	Grade 1
2	1.0mm	ceramic	4111-1	4111-11
2	1.0mm	alloy steel	4111-1A	4111-11A
2	2.0mm	ceramic	4111-2	4111-12
2	2.0mm	alloy steel	4111-2A	4111-12A

CERAMIC GAGE BLOCK SETS

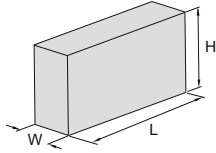

Dimension:

Size (L)	W	H
0.5 ≤ L ≤ 10mm	9mm	30mm
L > 10mm	9mm	35mm



- Made of ceramic, extremely wear resistance and corrosion resistance, excellent dimension stability
- Meet ISO3650
- Supplied with manufacturer inspection certificate

4105-87

Blocks per set	Gage blocks included in set			Code	
	Size (mm)	Step (mm)	Quantity	Grade 0	Grade 1
112	1.0005		1	4105-112	4105-1112
	1.001-1.009	0.001	9		
	1.01-1.49	0.01	49		
	0.5-24.5	0.5	49		
	25-100	25	4		
103	1.005		1	4105-103	4105-1103
	1.01-1.49	0.01	49		
	0.5-24.5	0.5	49		
	25-100	25	4		
88	1.0005		1	4105-88	4105-188
	1.001-1.009	0.001	9		
	1.01-1.49	0.01	49		
	0.5-9.5	0.5	19		
	10-100	10	10		
87	1.001-1.009	0.001	9	4105-87	4105-187
	1.01-1.49	0.01	49		
	0.5-9.5	0.5	19		
	10-100	10	10		
76	1.005		1	4105-76	4105-176
	1.01-1.49	0.01	49		
	0.5-9.5	0.5	19		
	10-40	10	4		
	50-100	25	3		
56	0.5		1	4105-56	4105-156
	1.001-1.009	0.001	9		
	1.01-1.09	0.01	9		
	1.1-1.9	0.1	9		
	1-24	1	24		
	25-100	25	4		

Blocks per set	Gage blocks included in set			Code	
	Size (mm)	Step (mm)	Quantity	Grade 0	Grade 1
47	1.005		1	4105-47A	4105-147A
	1.01-1.09	0.01	9		
	1.1-1.9	0.1	9		
	1-24	1	24		
	25-100	25	4		
47	1.005		1	4105-47	4105-147
	1.01-1.19	0.01	19		
	1.2-1.9	0.1	8		
	1-9	1	9		
	10-100	10	10		
46	1.001-1.009	0.001	9	4105-46	4105-146
	1.01-1.09	0.01	9		
	1.1-1.9	0.1	9		
	1-9	1	9		
	10-100	10	10		
34	1.0005		1	4105-34	4105-134
	1.001-1.009	0.001	9		
	1.01-1.09	0.01	9		
	1.1-1.9	0.1	9		
	1-5	1	5		
32	10		1	4105-32	4105-132
	1.005		1		
	1.01-1.09	0.01	9		
	1.1-1.9	0.1	9		
	1-9	1	9		
	10-30	10	3		
8	50		1	4105-8	4105-18
	125-175	25	3		
	200-250	50	2		
8	300-500	100	3	4105-8	4105-18

INDIVIDUAL CERAMIC GAGE BLOCKS



4106-A80

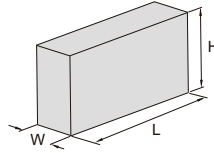

Dimension:

Size (L)	W	H
0.5 ≤ L ≤ 10mm	9mm	30mm
L > 10mm	9mm	35mm

9

- Grade 0 and 1 gage blocks are available
- Made of ceramic, extremely wear resistance and corrosion resistance
- Meet ISO3650
- Supplied with manufacturer inspection certificate

Code explanation:

4106-X□□□□□

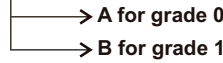

Code examples:

Size (L)	Grade	Code
0.5mm	0	4106-AD5
10mm	1	4106-B10

Size	Code	Size	Code	Size	Code	Size	Code
0.5mm	4106- <u>X</u> D5	1.23mm	4106- <u>X</u> 1D23	3mm	4106- <u>X</u> 3	17.6mm	4106- <u>X</u> 17D6
1mm	4106- <u>X</u> 1	1.24mm	4106- <u>X</u> 1D24	3.5mm	4106- <u>X</u> 3D5	18mm	4106- <u>X</u> 18
1.0005mm	4106- <u>X</u> 1D0005	1.25mm	4106- <u>X</u> 1D25	4mm	4106- <u>X</u> 4	18.5mm	4106- <u>X</u> 18D5
1.001mm	4106- <u>X</u> 1D001	1.26mm	4106- <u>X</u> 1D26	4.5mm	4106- <u>X</u> 4D5	19mm	4106- <u>X</u> 19
1.002mm	4106- <u>X</u> 1D002	1.27mm	4106- <u>X</u> 1D27	5mm	4106- <u>X</u> 5	19.5mm	4106- <u>X</u> 19D5
1.003mm	4106- <u>X</u> 1D003	1.28mm	4106- <u>X</u> 1D28	5.1mm	4106- <u>X</u> 5D1	20mm	4106- <u>X</u> 20
1.004mm	4106- <u>X</u> 1D004	1.29mm	4106- <u>X</u> 1D29	5.5mm	4106- <u>X</u> 5D5	20.2mm	4106- <u>X</u> 20D2
1.005mm	4106- <u>X</u> 1D005	1.3mm	4106- <u>X</u> 1D3	6mm	4106- <u>X</u> 6	20.5mm	4106- <u>X</u> 20D5
1.006mm	4106- <u>X</u> 1D006	1.31mm	4106- <u>X</u> 1D31	6.5mm	4106- <u>X</u> 6D5	21mm	4106- <u>X</u> 21
1.007mm	4106- <u>X</u> 1D007	1.32mm	4106- <u>X</u> 1D32	7mm	4106- <u>X</u> 7	21.5mm	4106- <u>X</u> 21D5
1.008mm	4106- <u>X</u> 1D008	1.33mm	4106- <u>X</u> 1D33	7.5mm	4106- <u>X</u> 7D5	22mm	4106- <u>X</u> 22
1.009mm	4106- <u>X</u> 1D009	1.34mm	4106- <u>X</u> 1D34	7.7mm	4106- <u>X</u> 7D7	22.5mm	4106- <u>X</u> 22D5
1.01mm	4106- <u>X</u> 1D01	1.35mm	4106- <u>X</u> 1D35	8mm	4106- <u>X</u> 8	22.8mm	4106- <u>X</u> 22D8
1.02mm	4106- <u>X</u> 1D02	1.36mm	4106- <u>X</u> 1D36	8.5mm	4106- <u>X</u> 8D5	23mm	4106- <u>X</u> 23
1.03mm	4106- <u>X</u> 1D03	1.37mm	4106- <u>X</u> 1D37	9mm	4106- <u>X</u> 9	23.5mm	4106- <u>X</u> 23D5
1.04mm	4106- <u>X</u> 1D04	1.38mm	4106- <u>X</u> 1D38	9.5mm	4106- <u>X</u> 9D5	24mm	4106- <u>X</u> 24
1.05mm	4106- <u>X</u> 1D05	1.39mm	4106- <u>X</u> 1D39	10mm	4106- <u>X</u> 10	24.5mm	4106- <u>X</u> 24D5
1.06mm	4106- <u>X</u> 1D06	1.4mm	4106- <u>X</u> 1D4	10.3mm	4106- <u>X</u> 10D3	25mm	4106- <u>X</u> 25
1.07mm	4106- <u>X</u> 1D07	1.41mm	4106- <u>X</u> 1D41	10.5mm	4106- <u>X</u> 10D5	30mm	4106- <u>X</u> 30
1.08mm	4106- <u>X</u> 1D08	1.42mm	4106- <u>X</u> 1D42	11mm	4106- <u>X</u> 11	40mm	4106- <u>X</u> 40
1.09mm	4106- <u>X</u> 1D09	1.43mm	4106- <u>X</u> 1D43	11.5mm	4106- <u>X</u> 11D5	41.3mm	4106- <u>X</u> 41D3
1.1mm	4106- <u>X</u> 1D1	1.44mm	4106- <u>X</u> 1D44	12mm	4106- <u>X</u> 12	50mm	4106- <u>X</u> 50
1.11mm	4106- <u>X</u> 1D11	1.45mm	4106- <u>X</u> 1D45	12.5mm	4106- <u>X</u> 12D5	60mm	4106- <u>X</u> 60
1.12mm	4106- <u>X</u> 1D12	1.46mm	4106- <u>X</u> 1D46	12.9mm	4106- <u>X</u> 12D9	70mm	4106- <u>X</u> 70
1.13mm	4106- <u>X</u> 1D13	1.47mm	4106- <u>X</u> 1D47	13mm	4106- <u>X</u> 13	75mm	4106- <u>X</u> 75
1.14mm	4106- <u>X</u> 1D14	1.48mm	4106- <u>X</u> 1D48	13.5mm	4106- <u>X</u> 13D5	80mm	4106- <u>X</u> 80
1.15mm	4106- <u>X</u> 1D15	1.49mm	4106- <u>X</u> 1D49	14mm	4106- <u>X</u> 14	90mm	4106- <u>X</u> 90
1.16mm	4106- <u>X</u> 1D16	1.5mm	4106- <u>X</u> 1D5	14.5mm	4106- <u>X</u> 14D5	100mm	4106- <u>X</u> 100
1.17mm	4106- <u>X</u> 1D17	1.6mm	4106- <u>X</u> 1D6	15mm	4106- <u>X</u> 15	125mm	4106- <u>X</u> 125
1.18mm	4106- <u>X</u> 1D18	1.7mm	4106- <u>X</u> 1D7	15.5mm	4106- <u>X</u> 15D5	131.4mm	4106- <u>X</u> 131D4
1.19mm	4106- <u>X</u> 1D19	1.8mm	4106- <u>X</u> 1D8	16mm	4106- <u>X</u> 16	150mm	4106- <u>X</u> 150
1.2mm	4106- <u>X</u> 1D2	1.9mm	4106- <u>X</u> 1D9	16.5mm	4106- <u>X</u> 16D5		
1.21mm	4106- <u>X</u> 1D21	2mm	4106- <u>X</u> 2	17mm	4106- <u>X</u> 17		
1.22mm	4106- <u>X</u> 1D22	2.5mm	4106- <u>X</u> 2D5	17.5mm	4106- <u>X</u> 17D5		



STEEL GAGE BLOCK SETS

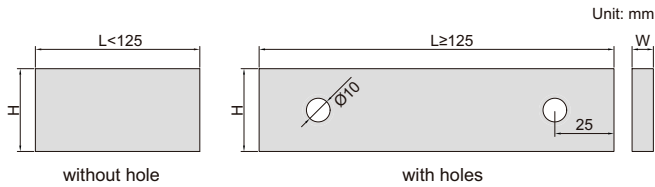

Dimension:

Size (L)	W	H
0.5 ≤ L ≤ 10mm	9mm	30mm
L > 10mm	9mm	35mm

Code example:
“-122” stands for “4100-122”

- Made of alloy steel
- Meet ISO3650
- Gage blocks ≥ 125mm have clamping holes
- Supplied with manufacturer inspection certificate



4100-87

Blocks per set	Gage blocks included in set			Code (4100)		
	Size (mm)	Step (mm)	Quantity	Grade 0	Grade 1	Grade 2
122	1.0005		1	-122	-1122	-2122
	1.001-1.009	0.001	9			
	1.01-1.49	0.01	49			
	1.6-1.9	0.1	4			
	0.5-24.5	0.5	49			
	30-100	10	8			
	25-75	50	2			
112	1.0005		1	-112	-1112	-2112
	1.001-1.009	0.001	9			
	1.01-1.49	0.01	49			
	0.5-24.5	0.5	49			
	25-100	25	4			
103	1.005		1	-103	-1103	-2103
	1.01-1.49	0.01	49			
	0.5-24.5	0.5	49			
	25-100	25	4			
88	1.0005		1	-88	-188	-288
	1.001-1.009	0.001	9			
	1.01-1.49	0.01	49			
	0.5-9.5	0.5	19			
	10-100	10	10			
87	1.001-1.009	0.001	9	-87	-187	-287
	1.01-1.49	0.01	49			
	0.5-9.5	0.5	19			
	10-100	10	10			
83	0.5		1	-83	-183	-283
	1		1			
	1.005		1			
	1.01-1.49	0.01	49			
	1.5-1.9	0.1	5			
	2-9.5	0.5	16			
	10-100	10	10			
76	1.005		1	-76	-176	-276
	1.01-1.49	0.01	49			
	0.5-9.5	0.5	19			
	10-40	10	4			
	50-100	25	3			

Blocks per set	Gage blocks included in set			Code (4100)		
	Size (mm)	Step (mm)	Quantity	Grade 0	Grade 1	Grade 2
56	0.5		1	-56	-156	-256
	1.001-1.009	0.001	9			
	1.01-1.09	0.01	9			
	1.1-1.9	0.1	9			
	1-24	1	24			
	25-100	25	4			
47	1.005		1	-47A	-147A	-247A
	1.01-1.09	0.01	9			
	1.1-1.9	0.1	9			
	1-24	1	24			
	25-100	25	4			
47	1.005		1	-47	-147	-247
	1.01-1.19	0.01	19			
	1.2-1.9	0.1	8			
	1-9	1	9			
	10-100	10	10			
46	1.001-1.009	0.001	9	-46	-146	-246
	1.01-1.09	0.01	9			
	1.1-1.9	0.1	9			
	1-9	1	9			
	10-100	10	10			
34	1.0005		1	-34	-134	-234
	1.001-1.009	0.001	9			
	1.01-1.09	0.01	9			
	1.1-1.9	0.1	9			
	1-5	1	5			
	10		1			
32	1.005		1	-32	-132	-232
	1.01-1.09	0.01	9			
	1.1-1.9	0.1	9			
	1-9	1	9			
	10-30	10	3			
	50		1			
9	1.001-1.009	0.001	9	-9	-19	-29
9	0.991-0.999	0.001	9	-9A	-19A	-29A
8	125-175	25	3	-8	-18	-28
	200-250	50	2			
	300-500	100	3			

INDIVIDUAL STEEL GAGE BLOCKS

CUSTOM-MADE
CAN SUPPLY ANY SIZES FROM
0.5 TO 1000MM, SUCH AS 72.672MM



4101-A70

4101-A200



- Grade 0, 1 and 2 gage blocks are available
- Made of alloy steel
- Meet ISO3650
- Gage blocks ≥ 125 mm have clamping holes
- Supplied with manufacturer inspection certificate

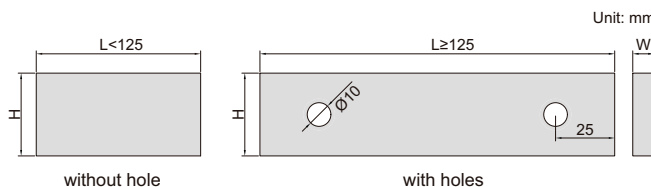

Unit: mm

Code explanation:

4101-X□□□□□

- A for grade 0
- B for grade 1
- C for grade 2

Code examples:

Size (L)	Grade	Code
0.5mm	0	4101-AD5
1mm	1	4101-B1
10.5mm	2	4101-C10D5

Dimension:

Size (L)	W	H
$0.5 \leq L \leq 10$ mm	9mm	30mm
$L > 10$ mm	9mm	35mm

Size	Code
0.5mm	4101-XD5
0.991mm	4101-XD991
0.992mm	4101-XD992
0.993mm	4101-XD993
0.994mm	4101-XD994
0.995mm	4101-XD995
0.996mm	4101-XD996
0.997mm	4101-XD997
0.998mm	4101-XD998
0.999mm	4101-XD999
1mm	4101-X1
1.0005mm	4101-X1D0005
1.001mm	4101-X1D001
1.002mm	4101-X1D002
1.003mm	4101-X1D003
1.004mm	4101-X1D004
1.005mm	4101-X1D005
1.006mm	4101-X1D006
1.007mm	4101-X1D007
1.008mm	4101-X1D008
1.009mm	4101-X1D009
1.01mm	4101-X1D01
1.02mm	4101-X1D02
1.03mm	4101-X1D03
1.04mm	4101-X1D04
1.05mm	4101-X1D05
1.06mm	4101-X1D06
1.07mm	4101-X1D07
1.08mm	4101-X1D08
1.09mm	4101-X1D09
1.1mm	4101-X1D1
1.11mm	4101-X1D11
1.12mm	4101-X1D12
1.13mm	4101-X1D13
1.14mm	4101-X1D14
1.15mm	4101-X1D15
1.16mm	4101-X1D16
1.17mm	4101-X1D17
1.18mm	4101-X1D18

Size	Code
1.19mm	4101-X1D19
1.2mm	4101-X1D2
1.21mm	4101-X1D21
1.22mm	4101-X1D22
1.23mm	4101-X1D23
1.24mm	4101-X1D24
1.25mm	4101-X1D25
1.26mm	4101-X1D26
1.27mm	4101-X1D27
1.28mm	4101-X1D28
1.29mm	4101-X1D29
1.3mm	4101-X1D3
1.31mm	4101-X1D31
1.32mm	4101-X1D32
1.33mm	4101-X1D33
1.34mm	4101-X1D34
1.35mm	4101-X1D35
1.36mm	4101-X1D36
1.37mm	4101-X1D37
1.38mm	4101-X1D38
1.39mm	4101-X1D39
1.4mm	4101-X1D4
1.41mm	4101-X1D41
1.42mm	4101-X1D42
1.43mm	4101-X1D43
1.44mm	4101-X1D44
1.45mm	4101-X1D45
1.46mm	4101-X1D46
1.47mm	4101-X1D47
1.48mm	4101-X1D48
1.49mm	4101-X1D49
1.5mm	4101-X1D5
1.6mm	4101-X1D6
1.7mm	4101-X1D7
1.8mm	4101-X1D8
1.9mm	4101-X1D9
2mm	4101-X2
2.5mm	4101-X2D5
3mm	4101-X3

Size	Code
3.5mm	4101-X3D5
4mm	4101-X4
4.5mm	4101-X4D5
5mm	4101-X5
5.1mm	4101-X5D1
5.5mm	4101-X5D5
6mm	4101-X6
6.5mm	4101-X6D5
7mm	4101-X7
7.5mm	4101-X7D5
7.7mm	4101-X7D7
8mm	4101-X8
8.5mm	4101-X8D5
9mm	4101-X9
9.5mm	4101-X9D5
10mm	4101-X10
10.3mm	4101-X10D3
10.5mm	4101-X10D5
11mm	4101-X11
11.5mm	4101-X11D5
12mm	4101-X12
12.5mm	4101-X12D5
12.9mm	4101-X12D9
13mm	4101-X13
13.5mm	4101-X13D5
14mm	4101-X14
14.5mm	4101-X14D5
15mm	4101-X15
15.5mm	4101-X15D5
16mm	4101-X16
16.5mm	4101-X16D5
17mm	4101-X17
17.5mm	4101-X17D5
17.6mm	4101-X17D6
18mm	4101-X18
18.5mm	4101-X18D5
19mm	4101-X19
19.5mm	4101-X19D5
20mm	4101-X20

Size	Code
20.2mm	4101-X20D2
20.5mm	4101-X20D5
21mm	4101-X21
21.5mm	4101-X21D5
22mm	4101-X22
22.5mm	4101-X22D5
22.8mm	4101-X22D8
23mm	4101-X23
23.5mm	4101-X23D5
24mm	4101-X24
24.5mm	4101-X24D5
25mm	4101-X25
30mm	4101-X30
35mm	4101-X35
40mm	4101-X40
41.3mm	4101-X41D3
45mm	4101-X45
50mm	4101-X50
60mm	4101-X60
70mm	4101-X70
75mm	4101-X75
80mm	4101-X80
90mm	4101-X90
100mm	4101-X100
125mm	4101-X125
131.4mm	4101-X131D4
150mm	4101-X150
175mm	4101-X175
200mm	4101-X200
250mm	4101-X250
300mm	4101-X300
400mm	4101-X400
500mm	4101-X500
600mm	4101-X600
700mm	4101-X700
750mm	4101-X750
800mm	4101-X800
900mm	4101-X900
1000mm	4101-X1000



CARBIDE GAGE BLOCK SETS

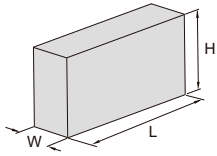

Dimension:

Size (L)	W	H
$0.5 \leq L \leq 10\text{mm}$	9mm	30mm
$L > 10\text{mm}$	9mm	35mm

- Made of carbide, extremely wear resistance and corrosion resistance, excellent dimension stability
- Meet ISO3650
- Supplied with manufacturer inspection certificate



4164-32

Blocks per set	Gage blocks included in set			Code	
	Size (mm)	Step (mm)	Quantity	Grade 0	Grade 1
122	1.0005		1	4164-122	4164-1122
	1.001-1.009	0.001	9		
	1.01-1.49	0.01	49		
	1.6-1.9	0.1	4		
	0.5-24.5	0.5	49		
	30-100	10	8		
	25-75	50	2		
112	1.0005		1	4164-112	4164-1112
	1.001-1.009	0.001	9		
	1.01-1.49	0.01	49		
	0.5-24.5	0.5	49		
	25-100	25	4		
103	1.005		1	4164-103	4164-1103
	1.01-1.49	0.01	49		
	0.5-24.5	0.5	49		
	25-100	25	4		
87	1.001-1.009	0.001	9	4164-87	4164-187
	1.01-1.49	0.01	49		
	0.5-9.5	0.5	19		
	10-100	10	10		
83	0.5		1	4164-83	4164-183
	1		1		
	1.005		1		
	1.01-1.49	0.01	49		
	1.5-1.9	0.1	5		
	2-9.5	0.5	16		
	10-100	10	10		

Blocks per set	Gage blocks included in set			Code	
	Size (mm)	Step (mm)	Quantity	Grade 0	Grade 1
76	1.005		1	4164-76	4164-176
	1.01-1.49	0.01	49		
	0.5-9.5	0.5	19		
	10-40	10	4		
	50-100	25	3		
47	1.005		1	4164-47A	4164-147A
	1.01-1.09	0.01	9		
	1.1-1.9	0.1	9		
	1-24	1	24		
47	1.005		1	4164-47	4164-147
	1.01-1.19	0.01	19		
	1.2-1.9	0.1	8		
	1-9	1	9		
46	1.001-1.009	0.001	9	4164-46	4164-146
	1.01-1.09	0.01	9		
	1.1-1.9	0.1	9		
	1-9	1	9		
	10-100	10	10		
32	1.005		1	4164-32	4164-132
	1.01-1.09	0.01	9		
	1.1-1.9	0.1	9		
	1-9	1	9		
	10-30	10	3		
	50		1		



CALIPER INSPECTION GAGE BLOCK SET

- Meet ISO3650/grade 2
- Supplied with manufacturer inspection certificate

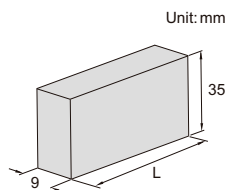

(mm)



4108-3005

Code	Material	Blocks per set	Gage blocks included in set (L)	Applicable calipers
4108-3005	alloy steel	5	30, 41.3, 131.4, 243.5, 281.2	0-150, 0-200, 0-300

MICROMETER INSPECTION GAGE BLOCK SETS



4107-10

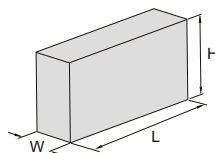

Dimension:

Size (L)	W	H
$0.5 \leq L \leq 10\text{mm}$	9mm	30mm
$L > 10\text{mm}$	9mm	35mm

Code	Material	Gage blocks included in set	Applicable micrometer	Optical flat
4107-10	ceramic	2.5mm, 5.1mm, 7.7mm, 10.3mm, 12.9mm, 15mm, 17.6mm, 20.2mm, 22.8mm, 25mm, optical flat	0-25mm	included
4107-101	alloy steel	2.5mm, 5.1mm, 7.7mm, 10.3mm, 12.9mm, 15mm, 17.6mm, 20.2mm, 22.8mm, 25mm, optical flat	0-25mm	included
4107-112	alloy steel	25mm, 27.5mm, 30.1mm, 32.7mm, 35.3mm, 37.9mm, 40mm, 42.6mm, 45.2mm, 47.8mm, 50mm	25-50mm	not included
4107-113	alloy steel	50mm, 52.5mm, 55.1mm, 57.7mm, 60.3mm, 62.9mm, 65mm, 67.6mm, 70.2mm, 72.8mm, 75mm	50-75mm	not included
4107-114	alloy steel	75mm, 77.5mm, 80.1mm, 82.7mm, 85.3mm, 87.9mm, 90mm, 92.6mm, 95.2mm, 97.8mm, 100mm	75-100mm	not included

- One piece of optical flat is included in 4107-10, 4107-101
- Meet ISO3650/grade 0
- Supplied with manufacturer inspection certificate

9

GAGE BLOCK HOLDERS

- Made of aluminum
- To be used with individual steel gage blocks (code 4101) as Go and No-Go gage

Code	Applicable gage block size
6883-1	1.5-5mm
6883-2	5-10mm
6883-3	10-15mm
6883-4	15-20mm
6883-5	20-25mm



6883-4

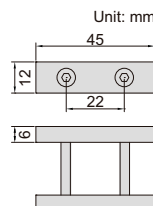

To be used as Go and No-Go gage



GAGE BLOCK HOLDER



Code

6886-1

6886-1

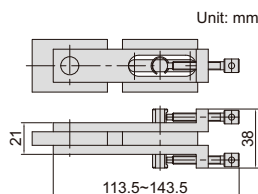

- For gage blocks over 100mm with clamping holes
- Optional accessory: gage block holder accessory, gage block accessory (code 6881)

application

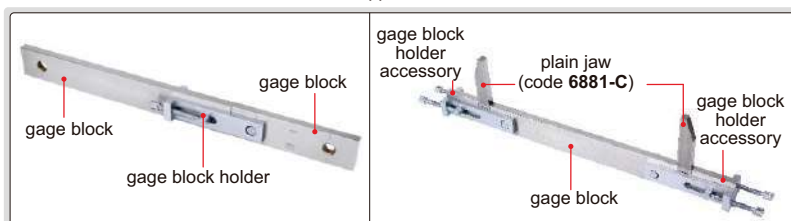

GAGE BLOCK HOLDER ACCESSORY



Code

6886-A

6886-A

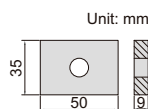

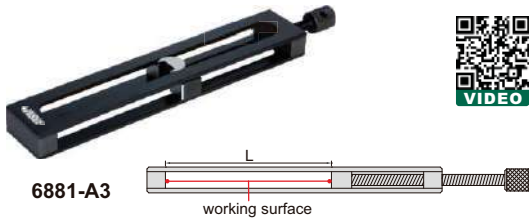

Code	Name	Clamping range* (L)
6881-A1	holder	0-25mm
6881-A2	holder	25-50mm
6881-A3	holder	50-100mm
6881-A4	holder	100-200mm
6881-A5	holder	200-300mm
6881-A6**	holder	300-500mm

* The actual clamping range should deduct the width of jaws
 ** Not suitable for base 6881-B



Code	Name	Remark
6881-F	scriber	made of carbide

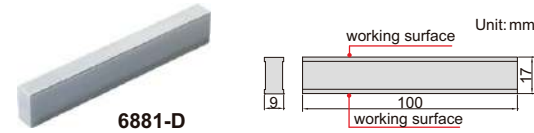

Code	Name	Remark
6881-D	parallel jaw	made of carbide



6881-S17

holder, 0-25mm (code 6881-A1)	1 pc
holder, 25-50mm (code 6881-A2)	1 pc
holder, 50-100mm (code 6881-A3)	1 pc
holder, 100-200mm (code 6881-A4)	1 pc
holder, 200-300mm (code 6881-A5)	1 pc
base (code 6881-B)	1 pc
plain jaw (code 6881-C)	1 pair
parallel jaw (code 6881-D)	1 pc
half round jaw, 2.5mm (code 6881-E1)	1 pair
half round jaw, 5.0mm (code 6881-E2)	1 pair
half round jaw, 6.0mm (code 6881-E3)	1 pair
scriber (code 6881-F)	1 pc
centre point (code 6881-G)	1 pc

GAGE BLOCK ACCESSORIES

Code	Name
6881-B	base

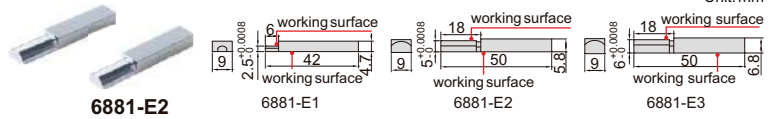
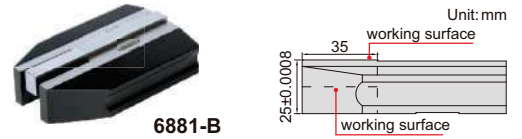

Code	Name	Size	Remark
6881-E1	half round jaw	2.5mm	made of carbide, supplied in pair
6881-E2	half round jaw	5.0mm	made of carbide, supplied in pair
6881-E3	half round jaw	6.0mm	made of carbide, supplied in pair

Code	Name	Remark
6881-C	plain jaw	made of carbide, supplied in pair



Code	Name	Remark
6881-G	centre point	the tip is made of carbide

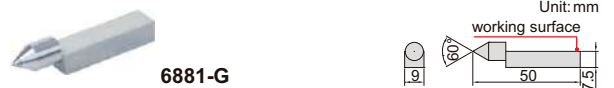

GAGE BLOCK ACCESSORY SET

Code	Mark
6881-S17	17 pcs (including the below items)

application

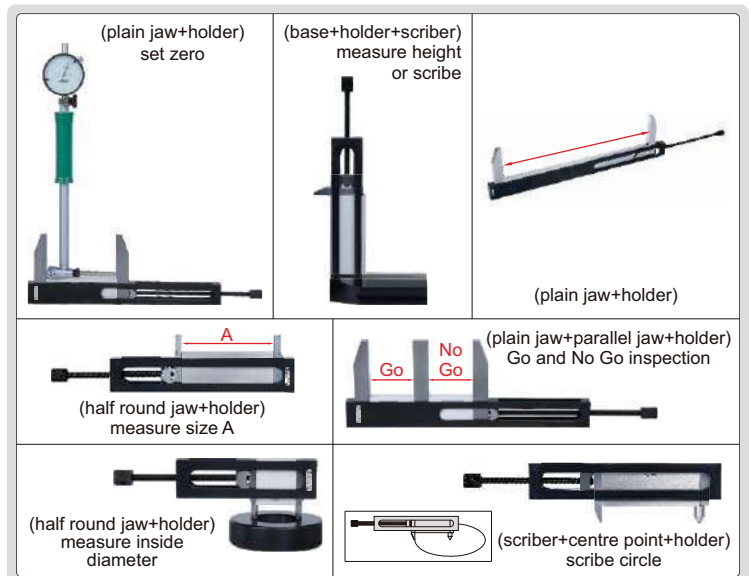

CUSTOM-MADE
CAN SUPPLY ANY LENGTH, SUCH AS 80.672MM



CYLINDER GAGE BLOCKS

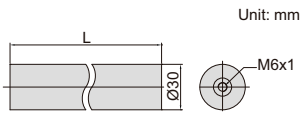

- Made of special alloy steel, hardness HRC64, high stability, wear resistance and easy combination
- Meet ISO3650 grade 1
- Can be connected with M6x1 screw and combined to any sizes up to 4m

can be combined to any sizes up to 4m

Combination 1: combined by several standard size cylinder gage blocks and one custom size cylinder gage block
For example: 500 (standard) + 200 (standard) + 25.832 (custom)=725.832mm
Note: in order to reduce cost, custom size should be within 100mm



Combination 2: combined by standard size cylinder gage blocks and rectangular gage blocks
For example: 500 (cylinder) + 200 (cylinder) + 21.5 (rectangular) + 2.33 (rectangular) + 2.002 (rectangular)=725.832mm

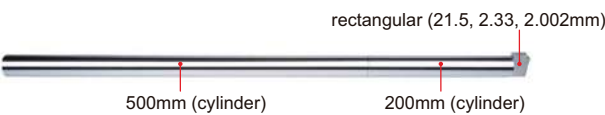

high stability in vertical position,
suitable for checking height gages



Code	Length (L)
4001-25 *	25mm
4001-50 *	50mm
4001-75 *	75mm
4001-100 *	100mm
4001-200 *	200mm
4001-300 *	300mm
4001-400 *	400mm
4001-500 *	500mm

* Supplied with manufacturer inspection certificate

connected with M6x1mm screw

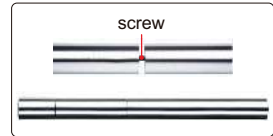

9

INTERNAL BLOCKS



4001-A

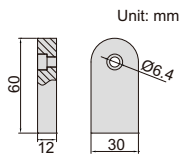

- Can be attached to cylinder and rectangular gage blocks
- Made of special alloy steel, hardness HRC64, high stability, wear resistance and easy combination
- Supplied in a matched pair

Code	Size	Flatness
4001-A	12mm	0.2µm

Combination 1: combined by several standard size cylinder gage blocks and one custom size cylinder gage block
For example: 500 (standard) + 200 (standard) + 25.832 (custom)=725.832mm
Note: in order to reduce cost, custom size should be within 100mm



Combination 2: combined by standard size cylinder gage blocks and rectangular gage blocks
For example: 500 (cylinder) + 200 (cylinder) + 50 (rectangular) - 20 (rectangular) - 2.16 (rectangular) - 2.008 (rectangular)=725.832mm

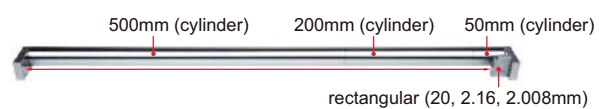

BASE



4001-B

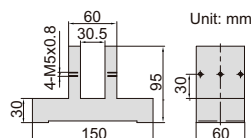

Code	Remark
4001-B	supplied in pair

working with base

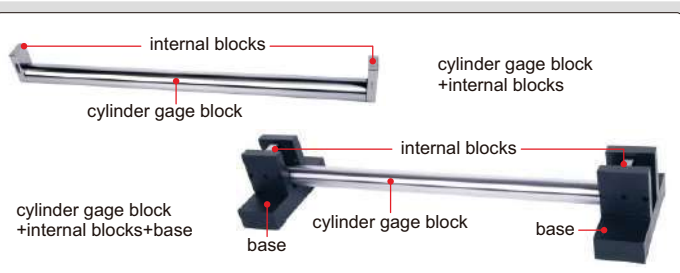

CALIPER/HEIGHT GAGE CHECKERS

**INSPECTION
CERTIFICATE**

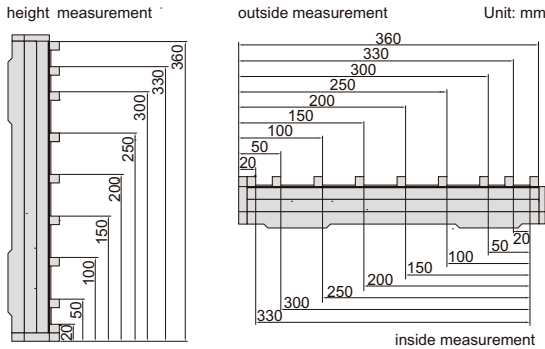

6884-300



horizontal



vertical

6884-300

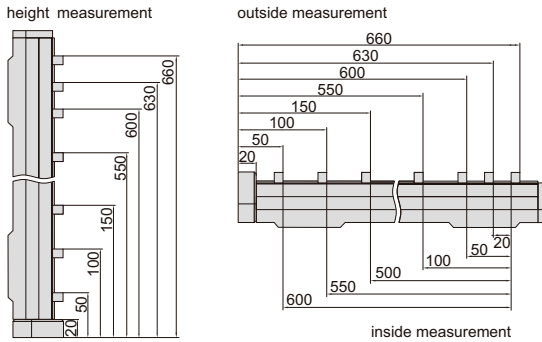

6884-600

check upper jaws of caliper

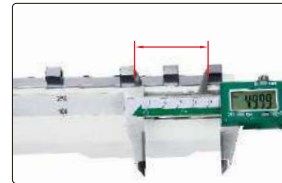

check lower jaws of caliper

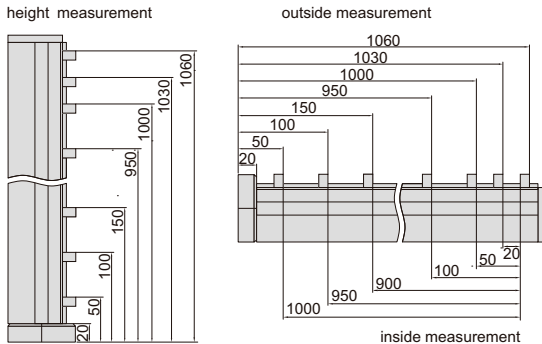
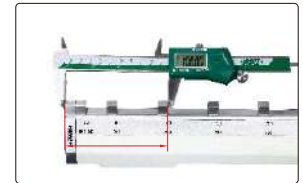

6884-1000

check height gage



- To check calipers and height gages
- Constructed with steel gage blocks

(mm)

Code	Size	Range of inside measurement	Range of outside measurement	Range of height measurement	Accuracy
6884-300*	0-300mm	20, 50, 100, 150, 200, 250, 300, 330	20, 50, 100, 150, 200, 250, 300, 330, 360	20, 50, 100, 150, 200, 250, 300, 330, 360	±5µm
6884-600*	0-600mm	20, 50, 100, 150, 200, 250, 300, 350, 400, 450, 500, 550, 600	20, 50, 100, 150, 200, 250, 300, 350, 400, 450, 500, 550, 600, 630, 660	20, 50, 100, 150, 200, 250, 300, 350, 400, 450, 500, 550, 600, 630, 660	±7µm
6884-1000*	0-1000mm	20, 50, 100, 150, 200, 250, 300, 350, 400, 450, 500, 550, 600, 650, 700, 750, 800, 850, 900, 950, 1000	20, 50, 100, 150, 200, 250, 300, 350, 400, 450, 500, 550, 600, 650, 700, 750, 800, 850, 900, 950, 1000, 1030, 1060	20, 50, 100, 150, 200, 250, 300, 350, 400, 450, 500, 550, 600, 650, 700, 750, 800, 850, 900, 950, 1000, 1030, 1060	±7µm

*Supplied with manufacturer inspection certificate

ANGLE GAGE BLOCKS



4002-15

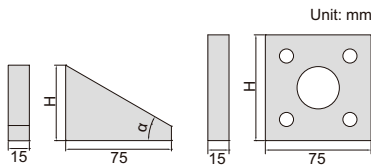

set angle of plate

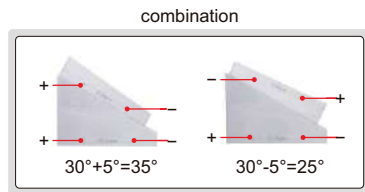

inspect angle



- Accuracy: $\pm 2''$
- To inspect protractor, taper gage, index plate, index head and goniometer, can also be used to set angle
- Made of special alloy steel, hardness HRC64, high stability, wear resistance and easy combination
- Can be combined to any angle with interval 6 seconds after combination (6", 12", 18", ... , 360")

Individual

Code	Angle (α)	H (mm)
4002-A1 *	1°	11.5
4002-A3 *	3°	14.0
4002-A5 *	5°	16.5
4002-A9 *	9°	22.0
4002-A15 *	15°	30.5
4002-A27 *	27°	48.0
4002-A30 *	30°	53.5
4002-A41 *	41°	75.0
4002-A45 *	45°	84.0
4002-B1 *	1'	10.0
4002-B3 *	3'	10.0
4002-B5 *	5'	10.0
4002-B9 *	9'	10.0
4002-B20 *	20'	10.0
4002-B27 *	27'	10.0
4002-B30 *	30'	10.0
4002-C6 *	6"	10.0
4002-C12 *	12"	10.0
4002-C18 *	18"	10.0
4002-C30 *	30"	10.0
4002-D *	90°/90°/90°/90°	75.0

Set

Code	Angle (α)	Total quantity
4002-13 *	1°, 3°, 9°, 27°, 41°, 1', 3', 9', 27', 6", 18", 30", 90°/90°/90°/90°	13
4002-15 *	1°, 3°, 5°, 15°, 30°, 45°, 1', 3', 5', 20', 30', 6", 12", 30", 90°/90°/90°/90°	15

*Supplied with manufacturer inspection certificate

INDIVIDUAL PIN GAGES WITH TWO DECIMAL PLACES (0.01MM STEP)

- Meet DIN2267, grade 1
- Diameter range: $\varnothing 0.20$ ~ $\varnothing 20.00$ mm
- Diameter accuracy: $\pm 1 \mu\text{m}$
- Made of alloy steel
- Hardness HRC62-65
- Optional accessory: wooden box

Diameter $\varnothing d$ (mm)
0.20, 0.21, 0.22, 0.23, ... 1.00
1.01, 1.02, 1.03, 1.04, ... 2.00
2.01, 2.02, 2.03, 2.04, ... 3.00
3.01, 3.02, 3.03, 3.04, ... 4.00
4.01, 4.02, 4.03, 4.04, ... 5.00
5.01, 5.02, 5.03, 5.04, ... 6.00
6.01, 6.02, 6.03, 6.04, ... 7.00
7.01, 7.02, 7.03, 7.04, ... 8.00
8.01, 8.02, 8.03, 8.04, ... 9.00
9.01, 9.02, 9.03, 9.04, ... 10.00

Diameter $\varnothing d$ (mm)
10.01, 10.02, 10.03, 10.04, ... 11.00
11.01, 11.02, 11.03, 11.04, ... 12.00
12.01, 12.02, 12.03, 12.04, ... 13.00
13.01, 13.02, 13.03, 13.04, ... 14.00
14.01, 14.02, 14.03, 14.04, ... 15.00
15.01, 15.02, 15.03, 15.04, ... 16.00
16.01, 16.02, 16.03, 16.04, ... 17.00
17.01, 17.02, 17.03, 17.04, ... 18.00
18.01, 18.02, 18.03, 18.04, ... 19.00
19.01, 19.02, 19.03, 19.04, ... 20.00



4110-9D98

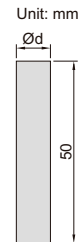

Code
4110-□□□□

Ordering examples:

Diameter	Code
0.21mm	4110-0D21
5.56mm	4110-5D56
16.00mm	4110-16D00

Note : "D" stands for "."

INDIVIDUAL PIN GAGES WITH THREE DECIMAL PLACES (0.001MM STEP)



- Meet DIN2267, grade 1
- Diameter range: $\varnothing 0.200\text{--}\varnothing 30.000\text{mm}$ with three decimal, for example 0.211mm, 5.562mm, 16.298mm
- Diameter accuracy: $\pm 1\mu\text{m}$
- Made of alloy steel
- Hardness HRC62-65
- Optional accessory: wooden box

Code	Diameter range $\varnothing d$ (mm)
4118-□□□□*	0.200~30.000

*Supplied with manufacturer inspection certificate

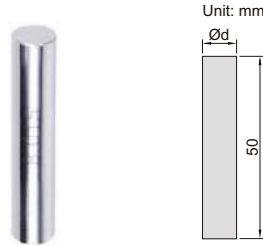

4118-8D015

Ordering examples:

Diameter	Code
0.211mm	4118-0D211
5.562mm	4118-5D562
16.298mm	4118-16D298

Note: "D" stands for "."

PIN GAGE SETS

- Meet DIN2267, grade 1
- Made of alloy steel
- Hardness HRC62-65
- Diameter accuracy: $\pm 1\mu\text{m}$



4166-6D

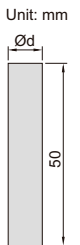

Code	Diameter $\varnothing d$ (mm)	Step	Pin gages per set
4166-2S	1.00, 1.01, 1.02, ..., 2.00	0.01mm	101
4166-3S	2.00, 2.01, 2.02, ..., 3.00	0.01mm	101
4166-4S	3.00, 3.01, 3.02, ..., 4.00	0.01mm	101
4166-5S	4.00, 4.01, 4.02, ..., 5.00	0.01mm	101
4166-6S	5.00, 5.01, 5.02, ..., 6.00	0.01mm	101
4166-7S	6.00, 6.01, 6.02, ..., 7.00	0.01mm	101
4166-8S	7.00, 7.01, 7.02, ..., 8.00	0.01mm	101
4166-9S	8.00, 8.01, 8.02, ..., 9.00	0.01mm	101
4166-10S	9.00, 9.01, 9.02, ..., 10.00	0.01mm	101

Code	Diameter $\varnothing d$ (mm)	Step	Pin gages per set
4166-411	1.0, 1.1, 1.2, ..., 5.0	0.1mm	41
4166-511	5.0, 5.1, 5.2, ..., 10.0	0.1mm	51
4166-512	10.0, 10.1, 10.2, ..., 15.0	0.1mm	51
4166-513	15.0, 15.1, 15.2, ..., 20.0	0.1mm	51

Code	Diameter $\varnothing d$ (mm)	Step	Pin gages per set
4166-0D	0.20, 0.21, 0.22, ..., 0.50	0.01mm	31
4166-1	0.50, 0.51, 0.52, ..., 1.00	0.01mm	51
4166-1D	1.00, 1.01, 1.02, ..., 1.50	0.01mm	51
4166-2	1.50, 1.51, 1.52, ..., 2.00	0.01mm	51
4166-2D	2.00, 2.01, 2.02, ..., 2.50	0.01mm	51
4166-3	2.50, 2.51, 2.52, ..., 3.00	0.01mm	51
4166-3D	3.00, 3.01, 3.02, ..., 3.50	0.01mm	51
4166-4	3.50, 3.51, 3.52, ..., 4.00	0.01mm	51
4166-4D	4.00, 4.01, 4.02, ..., 4.50	0.01mm	51
4166-5	4.50, 4.51, 4.52, ..., 5.00	0.01mm	51
4166-5D	5.00, 5.01, 5.02, ..., 5.50	0.01mm	51
4166-6	5.50, 5.51, 5.52, ..., 6.00	0.01mm	51
4166-6D	6.00, 6.01, 6.02, ..., 6.50	0.01mm	51
4166-7	6.50, 6.51, 6.52, ..., 7.00	0.01mm	51
4166-7D	7.00, 7.01, 7.02, ..., 7.50	0.01mm	51
4166-8	7.50, 7.51, 7.52, ..., 8.00	0.01mm	51
4166-8D	8.00, 8.01, 8.02, ..., 8.50	0.01mm	51
4166-9	8.50, 8.51, 8.52, ..., 9.00	0.01mm	51
4166-9D	9.00, 9.01, 9.02, ..., 9.50	0.01mm	51
4166-10	9.50, 9.51, 9.52, ..., 10.00	0.01mm	51

Code	Diameter $\varnothing d$ (mm)	Step	Pin gages per set
4166-10D	10.00, 10.01, 10.02, ..., 10.50	0.01mm	51
4166-11	10.50, 10.51, 10.52, ..., 11.00	0.01mm	51
4166-11D	11.00, 11.01, 11.02, ..., 11.50	0.01mm	51
4166-12	11.50, 11.51, 11.52, ..., 12.00	0.01mm	51
4166-12D	12.00, 12.01, 12.02, ..., 12.50	0.01mm	51
4166-13	12.50, 12.51, 12.52, ..., 13.00	0.01mm	51
4166-13D	13.00, 13.01, 13.02, ..., 13.50	0.01mm	51
4166-14	13.50, 13.51, 13.52, ..., 14.00	0.01mm	51
4166-14D	14.00, 14.01, 14.02, ..., 14.50	0.01mm	51
4166-15	14.50, 14.51, 14.52, ..., 15.00	0.01mm	51
4166-15D	15.00, 15.01, 15.02, ..., 15.50	0.01mm	51
4166-16	15.50, 15.51, 15.52, ..., 16.00	0.01mm	51
4166-16D	16.00, 16.01, 16.02, ..., 16.50	0.01mm	51
4166-17	16.50, 16.51, 16.52, ..., 17.00	0.01mm	51
4166-17D	17.00, 17.01, 17.02, ..., 17.50	0.01mm	51
4166-18	17.50, 17.51, 17.52, ..., 18.00	0.01mm	51
4166-18D	18.00, 18.01, 18.02, ..., 18.50	0.01mm	51
4166-19	18.50, 18.51, 18.52, ..., 19.00	0.01mm	51
4166-19D	19.00, 19.01, 19.02, ..., 19.50	0.01mm	51
4166-20	19.50, 19.51, 19.52, ..., 20.00	0.01mm	51

BOXES FOR PIN GAGES

- For individual pin gages (4110 and 4118 series)

Code	Applicable pin gage diameter Ød	Quantity of pin gages
7340	0.20-10.00mm	51 pcs
7340-101	0.20-10.00mm	101 pcs
7340-201	10.00-15.00mm	51 pcs
7340-202	15.00-20.00mm	51 pcs



7340

PIN GAGE HANDLES

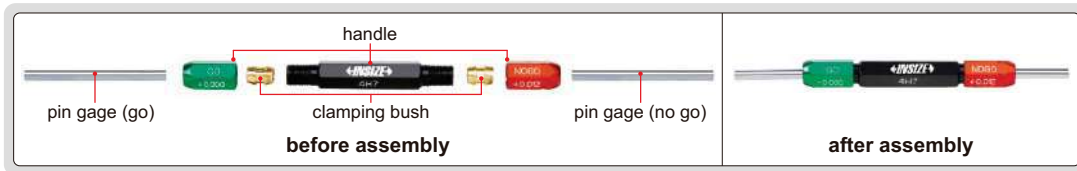

- Wrench is needed to install pins
- Clamping bushes (0.2~7.14mm) are made of brass, clamping bushes (7.14~25.65mm) are made of aluminum



Handle



brass (0.2~7.14mm)
aluminum (7.14~25.65mm)
clamping bush

Code	Applicable pin gage diameter	Including	
		Handle	Clamping bush (mm)
7341-0S	0.2-1.02mm	1 pc	6 pairs (the clamping range are 0.2-0.38, 0.38-0.51, 0.51-0.64, 0.64-0.76, 0.76-0.89, 0.89-1.02)
7341-1S	1.02-1.91mm	1 pc	7 pairs (the clamping range are 1.02-1.14, 1.14-1.27, 1.27-1.40, 1.40-1.52, 1.52-1.65, 1.65-1.78, 1.78-1.91)
7341-2S	1.91-3.33mm	1 pc	8 pairs (the clamping range are 1.91-2.08, 2.08-2.26, 2.26-2.44, 2.44-2.62, 2.62-2.79, 2.79-2.97, 2.97-3.15, 3.15-3.33)
7341-3S	3.33-4.57mm	1 pc	7 pairs (the clamping range are 3.33-3.51, 3.51-3.68, 3.68-3.86, 3.86-4.04, 4.04-4.22, 4.22-4.39, 4.39-4.57)
7341-4S	4.57-5.79mm	1 pc	6 pairs (the clamping range are 4.57-4.78, 4.78-4.98, 4.98-5.18, 5.18-5.38, 5.38-5.59, 5.59-5.79)
7341-5S	5.79-7.14mm	1 pc	6 pairs (the clamping range are 5.79-5.99, 5.99-6.20, 6.20-6.40, 6.40-6.63, 6.63-6.88, 6.88-7.14)

Code	Applicable pin gage diameter	Including	
		Handle	Clamping bush (mm)
7341-6S	7.14-8.66mm	1 pc	6 pairs (the clamping range are 7.14-7.39, 7.39-7.65, 7.65-7.90, 7.90-8.15, 8.15-8.41, 8.41-8.66)
7341-7S	8.66-10.31mm	1 pc	6 pairs (the clamping range are 8.66-8.92, 8.9-9.17, 9.17-9.42, 9.42-9.70, 9.70-10.01, 10.01-10.31)
7341-8S	10.31-11.81mm	1 pc	4 pairs (the clamping range are 10.31-10.67, 10.67-11.05, 11.05-11.43, 11.43-11.81)
7341-9S	11.81-12.95mm	1 pc	3 pairs (the clamping range are 11.81-12.19, 12.19-12.57, 12.57-12.95)
7341-10S	12.95-14.71mm	1 pc	4 pairs (the clamping range are 12.95-13.51, 13.51-13.89, 13.89-14.30, 14.30-14.71)
7341-11S	14.71-16.13mm	1 pc	4 pairs (the clamping range are 14.71-15.09, 15.09-15.49, 15.49-15.88, 15.88-16.13)
7341-12S	16.13-17.88mm	1 pc	4 pairs (the clamping range are 16.13-16.66, 16.66-17.07, 17.07-17.48, 17.48-17.88)
7341-13S	17.88-19.30mm	1 pc	4 pairs (the clamping range are 17.88-18.26, 18.26-18.67, 18.67-19.05, 19.05-19.30)
7341-15S	19.30-25.65mm	1 pc	8 pairs (the clamping range are 19.30-19.84, 19.84-20.62, 20.62-21.41, 21.41-22.23, 22.23-23.03, 23.03-23.80, 23.80-24.59, 24.59-25.65)

CAN SUPPLY CUSTOM SETTING RING FROM Ø1.500MM TO Ø315.000MM, FOR EXAMPLE, Ø17.085MM

SETTING RINGS



6312-20

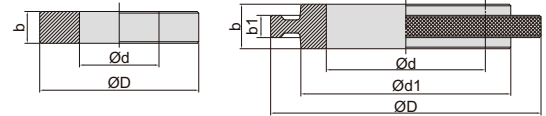

Ø1.5mm-100mm

Ø100mm-315mm

- For zero setting of inside micrometers, three points internal micrometers and bore gages
- Deviation (difference between the ordered size and the size marked on the setting ring when supplied): For example, the ordered size is Ø10.125mm, the size marked on the setting ring when supplied may be Ø10.127mm
- Meet DIN2250-1:2008

Diameter d**	b	D	Deviation	Roundness and cylindricity
Ø1.5-2.5	4	22	±10.0µm	0.3µm
Ø2.5-3	5	22	±10.0µm	0.3µm
Ø3-5	5	22	±10.0µm	0.4µm
Ø5-10	8	32	±10.0µm	0.4µm
Ø10-15	10	38	±10.0µm	0.5µm
Ø15-18	12	45	±10.0µm	0.5µm
Ø18-20	12	45	±10.0µm	0.6µm
Ø20-25	14	53	±10.0µm	0.6µm
Ø25-30	16	63	±10.0µm	0.6µm
Ø30-32	16	63	±10.0µm	0.7µm
Ø32-40	18	71	±10.0µm	0.7µm
Ø40-50	20	85	±10.0µm	0.7µm
Ø50-60	20	100	±10.0µm	0.8µm
Ø60-70	24	112	±10.0µm	0.8µm
Ø70-80	24	125	±10.0µm	0.8µm
Ø80-90	24	140	±10.0µm	1.0µm
Ø90-100	24	160	±10.0µm	1.0µm

** For example Ø3-5mm means Ø3mm< diameter d ≤ Ø5mm

Diameter d**	b	b1	d1	D	Deviation	Roundness and cylindricity
Ø100-110	28	14	132	170	±10.0µm	1.0µm
Ø110-120	28	16	140	180	±10.0µm	1.0µm
Ø120-130	28	16	150	190	±10.0µm	1.2µm
Ø130-140	28	18	160	200	±10.0µm	1.2µm
Ø140-150	28	18	170	212	±10.0µm	1.2µm
Ø150-160	28	20	180	224	±10.0µm	1.2µm
Ø160-170	32	20	190	236	±10.0µm	1.2µm
Ø170-180	32	20	200	250	±10.0µm	1.2µm
Ø180-190	32	22	212	265	±10.0µm	1.4µm
Ø190-200	32	22	224	280	±10.0µm	1.4µm
Ø200-212	32	22	236	300	±10.0µm	1.4µm
Ø212-224	32	25	250	315	±10.0µm	1.4µm
Ø224-236	36	25	265	335	±10.0µm	1.4µm
Ø236-250	36	28	280	355	±10.0µm	1.4µm
Ø250-265	36	28	300	375	±10.0µm	1.6µm
Ø265-280	36	28	315	400	±10.0µm	1.6µm
Ø280-300	36	32	335	425	±10.0µm	1.6µm
Ø300-315	36	32	355	450	±10.0µm	1.6µm

(mm)		(mm)		(mm)		(mm)		(mm)	
Code	Size	Code	Size	Code	Size	Code	Size	Code	Size
6312-1D5*	Ø1.5	6312-12D5*	Ø12.5	6312-23D5*	Ø23.5	6312-39*	Ø39	6312-95*	Ø95
6312-2*	Ø2	6312-13*	Ø13	6312-24*	Ø24	6312-40*	Ø40	6312-100*	Ø100
6312-2D5*	Ø2.5	6312-13D5*	Ø13.5	6312-24D5*	Ø24.5	6312-41*	Ø41	6312-112D5*	Ø112.5
6312-3*	Ø3	6312-14*	Ø14	6312-25*	Ø25	6312-42*	Ø42	6312-125*	Ø125
6312-3D5*	Ø3.5	6312-14D5*	Ø14.5	6312-25D5*	Ø25.5	6312-43*	Ø43	6312-137D5*	Ø137.5
6312-4*	Ø4	6312-15*	Ø15	6312-26*	Ø26	6312-44*	Ø44	6312-150*	Ø150
6312-4D5*	Ø4.5	6312-15D5*	Ø15.5	6312-26D5*	Ø26.5	6312-45*	Ø45	6312-162D5*	Ø162.5
6312-5*	Ø5	6312-16*	Ø16	6312-27*	Ø27	6312-46*	Ø46	6312-175*	Ø175
6312-5D5*	Ø5.5	6312-16D5*	Ø16.5	6312-27D5*	Ø27.5	6312-47*	Ø47	6312-187D5*	Ø187.5
6312-6*	Ø6	6312-17*	Ø17	6312-28*	Ø28	6312-48*	Ø48	6312-200*	Ø200
6312-6D5*	Ø6.5	6312-17D5*	Ø17.5	6312-28D5*	Ø28.5	6312-49*	Ø49	6312-212D5*	Ø212.5
6312-7*	Ø7	6312-18*	Ø18	6312-29*	Ø29	6312-50*	Ø50	6312-225*	Ø225
6312-7D5*	Ø7.5	6312-18D5*	Ø18.5	6312-29D5*	Ø29.5	6312-55*	Ø55	6312-237D5*	Ø237.5
6312-8*	Ø8	6312-19*	Ø19	6312-30*	Ø30	6312-60*	Ø60	6312-250*	Ø250
6312-8D5*	Ø8.5	6312-19D5*	Ø19.5	6312-31*	Ø31	6312-62*	Ø62	6312-262D5*	Ø262.5
6312-9*	Ø9	6312-20*	Ø20	6312-32*	Ø32	6312-65*	Ø65	6312-275*	Ø275
6312-9D5*	Ø9.5	6312-20D5*	Ø20.5	6312-33*	Ø33	6312-70*	Ø70	6312-287D5*	Ø287.5
6312-10*	Ø10	6312-21*	Ø21	6312-34*	Ø34	6312-75*	Ø75	6312-300*	Ø300
6312-10D5*	Ø10.5	6312-21D5*	Ø21.5	6312-35*	Ø35	6312-80*	Ø80		
6312-11*	Ø11	6312-22*	Ø22	6312-36*	Ø36	6312-85*	Ø85		
6312-11D5*	Ø11.5	6312-22D5*	Ø22.5	6312-37*	Ø37	6312-87*	Ø87		
6312-12*	Ø12	6312-23*	Ø23	6312-38*	Ø38	6312-90*	Ø90		

* Supplied with manufacturer inspection certificate

PLAIN PLUG GAGES

- Supplied with Go and No-Go gages together
- Class H7
- Hardness HRC 60±2
- Standard DIN7150-2



4124-12

CUSTOM-MADE
 OTHER CLASSES ARE AVAILABLE, SUCH AS H8, H9
 OTHER DIAMETERS ARE AVAILABLE, SUCH AS 19.003mm
 OTHER LENGTHS ARE AVAILABLE, SUCH AS 70mm

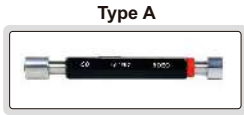

Type A

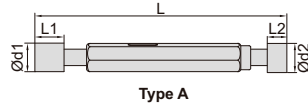

Type A



Type B

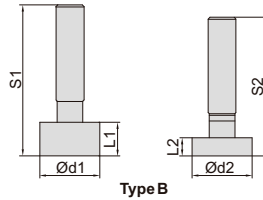

Type B

Size tolerance of H7

(mm)

Diameter Ød	Size tolerance of Go gage (µm)	Size tolerance of No-Go gage (µm)	L1	L2	L	S1, S2
≥2, ≤3	+0.5 / +2.5	+9 / +11	6.5	4.5	62	-
>3, ≤6	+0.75 / +3.25	+10.75 / +13.25	8	6	74	-
>6, ≤10	+0.75 / +3.25	+13.75 / +16.25	10	7	87	-
>10, ≤14	+1 / +4	+16.5 / +19.5	12	8	99	-
>14, ≤18	+1 / +4	+16.5 / +19.5	14	10	114	-
>18, ≤24	+1 / +5	+19 / +23	16	12	132	-
>24, ≤30	+1 / +5	+19 / +23	18	14	136	-
>30, ≤40	+1.5 / +5.5	+23 / +27	20	15	155	-
>40, ≤50	+1.5 / +5.5	+23 / +27	25	18	169	-
>50, ≤65	+1.5 / +6.5	+27.5 / +32.5	30	18	-	164, 152
>65, ≤80	+1.5 / +6.5	+27.5 / +32.5	35	25	-	169, 159
>80, ≤100	+2 / +8	+32 / +38	35	25	-	169, 159

Code	Diameter	Type	Code	Diameter	Type	Code	Diameter	Type	Code	Diameter	Type
4124-2	2mm	A	4124-17	17mm	A	4124-32	32mm	A	4124-47	47mm	A
4124-3	3mm	A	4124-18	18mm	A	4124-33	33mm	A	4124-48	48mm	A
4124-4	4mm	A	4124-19	19mm	A	4124-34	34mm	A	4124-49	49mm	A
4124-5	5mm	A	4124-20	20mm	A	4124-35	35mm	A	4124-50	50mm	A
4124-6	6mm	A	4124-21	21mm	A	4124-36	36mm	A	4124-52	52mm	B
4124-7	7mm	A	4124-22	22mm	A	4124-37	37mm	A	4124-55	55mm	B
4124-8	8mm	A	4124-23	23mm	A	4124-38	38mm	A	4124-60	60mm	B
4124-9	9mm	A	4124-24	24mm	A	4124-39	39mm	A	4124-65	65mm	B
4124-10	10mm	A	4124-25	25mm	A	4124-40	40mm	A	4124-70	70mm	B
4124-11	11mm	A	4124-26	26mm	A	4124-41	41mm	A	4124-75	75mm	B
4124-12	12mm	A	4124-27	27mm	A	4124-42	42mm	A	4124-80	80mm	B
4124-13	13mm	A	4124-28	28mm	A	4124-43	43mm	A	4124-85	85mm	B
4124-14	14mm	A	4124-29	29mm	A	4124-44	44mm	A	4124-90	90mm	B
4124-15	15mm	A	4124-30	30mm	A	4124-45	45mm	A	4124-95	95mm	B
4124-16	16mm	A	4124-31	31mm	A	4124-46	46mm	A	4124-100	100mm	B

METRIC THREAD PLUG GAGES

- Supplied with Go and No-Go gages together
- Standard ISO1502
- Supplied with manufacturer inspection certificate



4130-10



Code example:
 "-D8" stands for "4130-D8"

Size (mm)		Code (4130) *		
Nominal diameter	Pitch	Class 6H	Class 6G	Class 4H
M0.8	0.2	-D8	-D8G	-D8H
M0.9	0.225	-D9	-D9G	-D9H
M1	0.25	-1	-1G	-1H
M1.1	0.25	-1D1	-1D1G	-1D1H
M1.2	0.25	-1D2	-1D2G	-1D2H
M1.4	0.3	-1D4	-1D4G	-1D4H
M1.6	0.35	-1D6	-1D6G	-1D6H
M1.7	0.35	-1D7	-1D7G	-1D7H
M1.8	0.35	-1D8	-1D8G	-1D8H
M2	0.4	-2	-2G	-2H
M2.2	0.45	-2D2	-2D2G	-2D2H
M2.3	0.4	-2D3	-2D3G	-2D3H
M2.5	0.45	-2D5	-2D5G	-2D5H
M2.6	0.45	-2D6	-2D6G	-2D6H
M3	0.5	-3	-3G	-3H

Size (mm)		Code (4130) *		
Nominal diameter	Pitch	Class 6H	Class 6G	Class 4H
M3.5	0.6	-3D5	-3D5G	5H
M4	0.7	-4	-4G	-4H
M4.5	0.75	-4D5	-4D5G	-4D5H
M5	0.8	-5	-5G	-5H
M6	1	-6	-6G	-6H
M7	1	-7	-7G	-7H
M8	1.25	-8	-8G	-8H
M9	1.25	-9	-9G	-9H
M10	1.5	-10	-10G	-10H
M11	1.5	-11	-11G	-11H
M12	1.75	-12	-12G	-12H
M14	2	-14	-14G	-14H
M16	2	-16	-16G	-16H
M18	2.5	-18	-18G	-18H
M20	2.5	-20	-20G	-20H

Size (mm)		Code (4130) *		
Nominal diameter	Pitch	Class 6H	Class 6G	Class 4H
M22	2.5	-22	-22G	-22H
M24	3	-24	-24G	-24H
M27	3	-27	-27G	-27H
M30	3.5	-30	-30G	-30H
M33	3.5	-33	-33G	-33H
M36	4	-36	-36G	-36H
M39	4	-39	-39G	-39H
M42	4.5	-42	-42G	-42H
M45	4.5	-45	-45G	-45H
M48	5	-48	-48G	-48H
M52	5	-52	-52G	-52H
M56	5.5	-56	-56G	-56H
M60	5.5	-60	-60G	-60H

METRIC FINE THREAD PLUG GAGES



4139-20G

- Supplied with Go and No-Go gages together
- Standard ISO1502
- Supplied with manufacturer inspection certificate

Code example:
“-1A” stands for “4139-1A”

Size (mm)		Code (4139) *		
Nominal diameter	Pitch	Class 6H	Class 6G	Class 4H
M1	0.2	-1A	-1AG	-1AH
M1.2	0.2	-1D2A	-1D2AG	-1D2AH
M1.4	0.2	-1D4A	-1D4AG	-1D4AH
M1.6	0.2	-1D6A	-1D6AG	-1D6AH
M1.8	0.2	-1D8A	-1D8AG	-1D8AH
M2	0.2	-2A	-2AG	-2AH
	0.25	-2B	-2BG	-2BH
M2.5	0.2	-2D5A	-2D5AG	-2D5AH
	0.25	-2D5B	-2D5BG	-2D5BH
	0.35	-2D5D	-2D5DG	-2D5DH
M3	0.25	-3B	-3BG	-3BH
	0.35	-3D	-3DG	-3DH
M3.5	0.25	-3D5B	-3D5BG	-3D5BH
	0.35	-3D5D	-3D5DG	-3D5DH
	0.5	-3D5G	-3D5GG	-3D5GH
M4	0.25	-4B	-4BG	-4BH
	0.35	-4D	-4DG	-4DH
	0.5	-4G	-4GG	-4GH
M4.5	0.35	-4D5D	-4D5DG	-4D5DH
	0.5	-4D5G	-4D5GG	-4D5GH
M5	0.25	-5B	-5BG	-5BH
	0.35	-5D	-5DG	-5DH
	0.5	-5G	-5GG	-5GH
M5.5	0.5	-5D5G	-5D5GG	-5D5GH
M6	0.25	-6B	-6BG	-6BH
	0.35	-6D	-6DG	-6DH
M6.5	0.5	-6G	-6GG	-6GH
	0.5	-6D5G	-6D5GG	-6D5GH
M7	0.35	-7D	-7DG	-7DH
	0.5	-7G	-7GG	-7GH
M7.5	0.5	-7D5G	-7D5GG	-7D5GH
M8	0.35	-8D	-8DG	-8DH
	0.5	-8G	-8GG	-8GH
	1	-8P	-8PG	-8PH
M8.5	0.5	-8D5G	-8D5GG	-8D5GH
M9	0.35	-9D	-9DG	-9DH
	0.5	-9G	-9GG	-9GH
	0.75	-9L	-9LG	-9LH
	1	-9P	-9PG	-9PH
M10	0.35	-10D	-10DG	-10DH
	0.5	-10G	-10GG	-10GH
	1	-10P	-10PG	-10PH
M11	1.25	-10Q	-10QG	-10QH
	0.5	-11G	-11GG	-11GH
1	-11P	-11PG	-11PH	

Size (mm)		Code (4139) *		
Nominal diameter	Pitch	Class 6H	Class 6G	Class 4H
M12	0.5	-12G	-12GG	-12GH
	1	-12P	-12PG	-12PH
	1.25	-12Q	-12QG	-12QH
	1.5	-12R	-12RG	-12RH
M13	0.5	-13G	-13GG	-13GH
	1	-13P	-13PG	-13PH
M14	1.5	-13R	-13RG	-13RH
	0.5	-14G	-14GG	-14GH
M15	1	-14P	-14PG	-14PH
	1.25	-14Q	-14QG	-14QH
	1.5	-14R	-14RG	-14RH
M16	0.5	-15G	-15GG	-15GH
	1	-15P	-15PG	-15PH
	1.5	-15R	-15RG	-15RH
M17	0.5	-16G	-16GG	-16GH
	1	-16P	-16PG	-16PH
	1.25	-16Q	-16QG	-16QH
M18	1.5	-16R	-16RG	-16RH
	0.5	-17G	-17GG	-17GH
	1	-17P	-17PG	-17PH
M19	1.5	-17R	-17RG	-17RH
	0.5	-18G	-18GG	-18GH
	1	-18P	-18PG	-18PH
M20	1.25	-18Q	-18QG	-18QH
	1.5	-18R	-18RG	-18RH
	2	-18T	-18TG	-18TH
M21	0.5	-19G	-19GG	-19GH
	1	-19P	-19PG	-19PH
M22	1.5	-19R	-19RG	-19RH
	0.5	-20G	-20GG	-20GH
	1	-20P	-20PG	-20PH
M23	1.25	-20Q	-20QG	-20QH
	1.5	-20R	-20RG	-20RH
	2	-20T	-20TG	-20TH
M24	0.5	-21G	-21GG	-21GH
	1	-21P	-21PG	-21PH
	1.5	-21R	-21RG	-21RH
M25	0.5	-22G	-22GG	-22GH
	1	-22P	-22PG	-22PH
	1.25	-22Q	-22QG	-22QH
M26	1.5	-22R	-22RG	-22RH
	2	-22T	-22TG	-22TH
	0.5	-23G	-23GG	-23GH
1	-23P	-23PG	-23PH	

To be continued

Continued from previous page

Size (mm)		Code (4139) *		
Nominal diameter	Pitch	Class 6H	Class 6G	Class 4H
M24	0.5	-24G	-24GG	-24GH
	1	-24P	-24PG	-24PH
	1.25	-24Q	-24QG	-24QH
	1.5	-24R	-24RG	-24RH
	2	-24T	-24TG	-24TH
M25	0.5	-25G	-25GG	-25GH
	1	-25P	-25PG	-25PH
	1.5	-25R	-25RG	-25RH
	2	-25T	-25TG	-25TH
M26	0.5	-26G	-26GG	-26GH
	1	-26P	-26PG	-26PH
	1.5	-26R	-26RG	-26RH
M27	0.5	-27G	-27GG	-27GH
	1	-27P	-27PG	-27PH
	1.5	-27R	-27RG	-27RH
M28	0.5	-28G	-28GG	-28GH
	1	-28P	-28PG	-28PH
	1.5	-28R	-28RG	-28RH
M29	0.5	-29G	-29GG	-29GH
	0.75	-29L	-29LG	-29LH
	1	-29P	-29PG	-29PH
M30	0.5	-30G	-30GG	-30GH
	0.75	-30L	-30LG	-30LH
	1	-30P	-30PG	-30PH
	1.5	-30R	-30RG	-30RH
	2	-30T	-30TG	-30TH
M31	0.5	-31G	-31GG	-31GH
	0.75	-31L	-31LG	-31LH
M32	0.5	-32G	-32GG	-32GH
	0.75	-32L	-32LG	-32LH
	1	-32P	-32PG	-32PH
	1.5	-32R	-32RG	-32RH
M33	0.5	-33G	-33GG	-33GH
	0.75	-33L	-33LG	-33LH
	1	-33P	-33PG	-33PH
	1.5	-33R	-33RG	-33RH
	2	-33T	-33TG	-33TH
M34	0.75	-34L	-34LG	-34LH
	1	-34P	-34PG	-34PH
	1.5	-34R	-34RG	-34RH
M35	0.75	-35L	-35LG	-35LH
	1	-35P	-35PG	-35PH
	1.5	-35R	-35RG	-35RH
	2	-35T	-35TG	-35TH
M36	0.75	-36L	-36LG	-36LH
	1	-36P	-36PG	-36PH
	1.5	-36R	-36RG	-36RH
	2	-36T	-36TG	-36TH
M37	0.75	-37L	-37LG	-37LH

Size (mm)		Code (4139) *		
Nominal diameter	Pitch	Class 6H	Class 6G	Class 4H
M38	0.75	-38L	-38LG	-38LH
	1	-38P	-38PG	-38PH
	1.5	-38R	-38RG	-38RH
	2	-38T	-38TG	-38TH
M39	0.75	-39L	-39LG	-39LH
	1	-39P	-39PG	-39PH
	1.5	-39R	-39RG	-39RH
	2	-39T	-39TG	-39TH
M40	0.75	-40L	-40LG	-40LH
	1.5	-40R	-40RG	-40RH
	2	-40T	-40TG	-40TH
M42	1	-42P	-42PG	-42PH
	1.5	-42R	-42RG	-42RH
	2	-42T	-42TG	-42TH
M45	1	-45P	-45PG	-45PH
	1.5	-45R	-45RG	-45RH
	2	-45T	-45TG	-45TH
M48	1	-48P	-48PG	-48PH
	1.5	-48R	-48RG	-48RH
	2	-48T	-48TG	-48TH
M50	1	-50P	-50PG	-50PH
	1.5	-50R	-50RG	-50RH
	2	-50T	-50TG	-50TH
M52	1	-52P	-52PG	-52PH
	1.5	-52R	-52RG	-52RH
	2	-52T	-52TG	-52TH
	3	-52V	-52VG	-52VH
M55	1	-55P	-55PG	-55PH
	1.5	-55R	-55RG	-55RH
	2	-55T	-55TG	-55TH
	3	-55V	-55VG	-55VH
M56	1	-56P	-56PG	-56PH
	1.5	-56R	-56RG	-56RH
	2	-56T	-56TG	-56TH
	3	-56V	-56VG	-56VH
M58	1	-58P	-58PG	-58PH
	1.5	-58R	-58RG	-58RH
	2	-58T	-58TG	-58TH
	3	-58V	-58VG	-58VH
M60	1	-60P	-60PG	-60PH
	1.5	-60R	-60RG	-60RH
	2	-60T	-60TG	-60TH
	3	-60V	-60VG	-60VH

4120-16

4120-16N

- Standard ISO1502
- Supplied with manufacturer inspection certificate

Code example:
“-2” stands for “4120-2”

Size (mm)		Code (4120) *					
		Class 6g		Class 6e		Class 6h	
Nominal diameter	Pitch	GO	NOGO	GO	NOGO	GO	NOGO
M2	0.4	-2	-2N	-2E	-2EN	-2H	-2HN
M2.2	0.45	-2D2	-2D2N	-2D2E	-2D2EN	-2D2H	-2D2HN
M2.3	0.4	-2D3	-2D3N	-2D3E	-2D3EN	-2D3H	-2D3HN
M2.5	0.45	-2D5	-2D5N	-2D5E	-2D5EN	-2D5H	-2D5HN
M2.6	0.45	-2D6	-2D6N	-2D6E	-2D6EN	-2D6H	-2D6HN
M3	0.5	-3	-3N	-3E	-3EN	-3H	-3HN
M3.5	0.6	-3D5	-3D5N	-3D5E	-3D5EN	-3D5H	-3D5HN
M4	0.7	-4	-4N	-4E	-4EN	-4H	-4HN
M4.5	0.75	-4D5	-4D5N	-4D5E	-4D5EN	-4D5H	-4D5HN
M5	0.8	-5	-5N	-5E	-5EN	-5H	-5HN
M6	1	-6	-6N	-6E	-6EN	-6H	-6HN
M7	1	-7	-7N	-7E	-7EN	-7H	-7HN
M8	1.25	-8	-8N	-8E	-8EN	-8H	-8HN
M9	1.25	-9	-9N	-9E	-9EN	-9H	-9HN
M10	1.5	-10	-10N	-10E	-10EN	-10H	-10HN
M11	1.5	-11	-11N	-11E	-11EN	-11H	-11HN
M12	1.75	-12	-12N	-12E	-12EN	-12H	-12HN
M14	2	-14	-14N	-14E	-14EN	-14H	-14HN
M16	2	-16	-16N	-16E	-16EN	-16H	-16HN
M18	2.5	-18	-18N	-18E	-18EN	-18H	-18HN
M20	2.5	-20	-20N	-20E	-20EN	-20H	-20HN
M22	2.5	-22	-22N	-22E	-22EN	-22H	-22HN
M24	3	-24	-24N	-24E	-24EN	-24H	-24HN
M27	3	-27	-27N	-27E	-27EN	-27H	-27HN
M30	3.5	-30	-30N	-30E	-30EN	-30H	-30HN
M33	3.5	-33	-33N	-33E	-33EN	-33H	-33HN
M36	4	-36	-36N	-36E	-36EN	-36H	-36HN
M39	4	-39	-39N	-39E	-39EN	-39H	-39HN
M42	4.5	-42	-42N	-42E	-42EN	-42H	-42HN
M45	4.5	-45	-45N	-45E	-45EN	-45H	-45HN
M48	5	-48	-48N	-48E	-48EN	-48H	-48HN
M52	5	-52	-52N	-52E	-52EN	-52H	-52HN
M56	5.5	-56	-56N	-56E	-56EN	-56H	-56HN
M60	5.5	-60	-60N	-60E	-60EN	-60H	-60HN

METRIC FINE THREAD RING GAGES



- Standard ISO1502
- Supplied with manufacturer inspection certificate



4129-10P



4129-10PN

Code example:
“-2D5D” stands for “4129-2D5D”

Size (mm)		Code (4129) *					
		Class 6g		Class 6e		Class 6h	
Nominal diameter	Pitch	GO	NOGO	GO	NOGO	GO	NOGO
M2.5	0.35	-2D5D	-2D5DN	-2D5DE	-2D5DEN	-2D5DH	-2D5DHN
M3	0.35	-3D	-3DN	-3DE	-3DEN	-3DH	-3DHN
M3.5	0.35	-3D5D	-3D5DN	-3D5DE	-3D5DEN	-3D5DH	-3D5DHN
	0.5	-3D5G	-3D5GN	-3D5GE	-3D5GEN	-3D5GH	-3D5GHN
M4	0.35	-4D	-4DN	-4DE	-4DEN	-4DH	-4DHN
	0.5	-4G	-4GN	-4GE	-4GEN	-4GH	-4GHN
M4.5	0.35	-4D5D	-4D5DN	-4D5DE	-4D5DEN	-4D5DH	-4D5DHN
	0.5	-4D5G	-4D5GN	-4D5GE	-4D5GEN	-4D5GH	-4D5GHN
M5	0.35	-5D	-5DN	-5DE	-5DEN	-5DH	-5DHN
	0.5	-5G	-5GN	-5GE	-5GEN	-5GH	-5GHN
M5.5	0.5	-5D5G	-5D5GN	-5D5GE	-5D5GEN	-5D5GH	-5D5GHN
	0.35	-6D	-6DN	-6DE	-6DEN	-6DH	-6DHN
M6	0.5	-6G	-6GN	-6GE	-6GEN	-6GH	-6GHN
	0.75	-6L	-6LN	-6LE	-6LEN	-6LH	-6LHN
M6.5	0.5	-6D5G	-6D5GN	-6D5GE	-6D5GEN	-6D5GH	-6D5GHN
	0.35	-7D	-7DN	-7DE	-7DEN	-7DH	-7DHN
M7	0.5	-7G	-7GN	-7GE	-7GEN	-7GH	-7GHN
	0.75	-7L	-7LN	-7LE	-7LEN	-7LH	-7LHN
M7.5	0.5	-7D5G	-7D5GN	-7D5GE	-7D5GEN	-7D5GH	-7D5GHN
	0.35	-8D	-8DN	-8DE	-8DEN	-8DH	-8DHN
M8	0.5	-8G	-8GN	-8GE	-8GEN	-8GH	-8GHN
	0.75	-8L	-8LN	-8LE	-8LEN	-8LH	-8LHN
M8.5	1	-8P	-8PN	-8PE	-8PEN	-8PH	-8PHN
	0.5	-8D5G	-8D5GN	-8D5GE	-8D5GEN	-8D5GH	-8D5GHN
M9	0.35	-9D	-9DN	-9DE	-9DEN	-9DH	-9DHN
	0.5	-9G	-9GN	-9GE	-9GEN	-9GH	-9GHN
M10	0.75	-9L	-9LN	-9LE	-9LEN	-9LH	-9LHN
	1	-9P	-9PN	-9PE	-9PEN	-9PH	-9PHN
M11	0.35	-10D	-10DN	-10DE	-10DEN	-10DH	-10DHN
	0.5	-10G	-10GN	-10GE	-10GEN	-10GH	-10GHN
M12	0.75	-10L	-10LN	-10LE	-10LEN	-10LH	-10LHN
	1	-10P	-10PN	-10PE	-10PEN	-10PH	-10PHN
M13	1.25	-10Q	-10QN	-10QE	-10QEN	-10QH	-10QHN
	0.5	-11G	-11GN	-11GE	-11GEN	-11GH	-11GHN
M14	0.75	-11L	-11LN	-11LE	-11LEN	-11LH	-11LHN
	1	-11P	-11PN	-11PE	-11PEN	-11PH	-11PHN
M15	0.5	-12G	-12GN	-12GE	-12GEN	-12GH	-12GHN
	0.75	-12L	-12LN	-12LE	-12LEN	-12LH	-12LHN
M16	1	-12P	-12PN	-12PE	-12PEN	-12PH	-12PHN
	1.25	-12Q	-12QN	-12QE	-12QEN	-12QH	-12QHN
M17	1.5	-12R	-12RN	-12RE	-12REN	-12RH	-12RHN
	0.5	-13G	-13GN	-13GE	-13GEN	-13GH	-13GHN
M18	0.75	-13L	-13LN	-13LE	-13LEN	-13LH	-13LHN
	1	-13P	-13PN	-13PE	-13PEN	-13PH	-13PHN
M19	1.5	-13R	-13RN	-13RE	-13REN	-13RH	-13RHN

To be continued



Continued from previous page

Size (mm)		Code (4129) *					
Nominal diameter	Pitch	Class 6g		Class 6e		Class 6h	
		GO	NOGO	GO	NOGO	GO	NOGO
M14	0.5	-14G	-14GN	-14GE	-14GEN	-14GH	-14GHN
	0.75	-14L	-14LN	-14LE	-14LEN	-14LH	-14LHN
	1	-14P	-14PN	-14PE	-14PEN	-14PH	-14PHN
	1.25	-14Q	-14QN	-14QE	-14QEN	-14QH	-14QHN
	1.5	-14R	-14RN	-14RE	-14REN	-14RH	-14RHN
M15	0.5	-15G	-15GN	-15GE	-15GEN	-15GH	-15GHN
	0.75	-15L	-15LN	-15LE	-15LEN	-15LH	-15LHN
	1	-15P	-15PN	-15PE	-15PEN	-15PH	-15PHN
	1.5	-15R	-15RN	-15RE	-15REN	-15RH	-15RHN
M16	0.5	-16G	-16GN	-16GE	-16GEN	-16GH	-16GHN
	0.75	-16L	-16LN	-16LE	-16LEN	-16LH	-16LHN
	1	-16P	-16PN	-16PE	-16PEN	-16PH	-16PHN
	1.25	-16Q	-16QN	-16QE	-16QEN	-16QH	-16QHN
M17	1.5	-16R	-16RN	-16RE	-16REN	-16RH	-16RHN
	0.5	-17G	-17GN	-17GE	-17GEN	-17GH	-17GHN
	0.75	-17L	-17LN	-17LE	-17LEN	-17LH	-17LHN
	1	-17P	-17PN	-17PE	-17PEN	-17PH	-17PHN
M18	1.5	-17R	-17RN	-17RE	-17REN	-17RH	-17RHN
	0.5	-18G	-18GN	-18GE	-18GEN	-18GH	-18GHN
	0.75	-18L	-18LN	-18LE	-18LEN	-18LH	-18LHN
	1	-18P	-18PN	-18PE	-18PEN	-18PH	-18PHN
	1.25	-18Q	-18QN	-18QE	-18QEN	-18QH	-18QHN
M19	1.5	-18R	-18RN	-18RE	-18REN	-18RH	-18RHN
	2	-18T	-18TN	-18TE	-18TEN	-18TH	-18THN
	0.5	-19G	-19GN	-19GE	-19GEN	-19GH	-19GHN
	0.75	-19L	-19LN	-19LE	-19LEN	-19LH	-19LHN
M20	1	-19P	-19PN	-19PE	-19PEN	-19PH	-19PHN
	1.5	-19R	-19RN	-19RE	-19REN	-19RH	-19RHN
	0.5	-20G	-20GN	-20GE	-20GEN	-20GH	-20GHN
	0.75	-20L	-20LN	-20LE	-20LEN	-20LH	-20LHN
	1	-20P	-20PN	-20PE	-20PEN	-20PH	-20PHN
M21	1.25	-20Q	-20QN	-20QE	-20QEN	-20QH	-20QHN
	1.5	-20R	-20RN	-20RE	-20REN	-20RH	-20RHN
	2	-20T	-20TN	-20TE	-20TEN	-20TH	-20THN
	0.75	-21L	-21LN	-21LE	-21LEN	-21LH	-21LHN
M22	1	-21P	-21PN	-21PE	-21PEN	-21PH	-21PHN
	1.5	-21R	-21RN	-21RE	-21REN	-21RH	-21RHN
	0.75	-22L	-22LN	-22LE	-22LEN	-22LH	-22LHN
M23	1	-22P	-22PN	-22PE	-22PEN	-22PH	-22PHN
	1.25	-22Q	-22QN	-22QE	-22QEN	-22QH	-22QHN
	1.5	-22R	-22RN	-22RE	-22REN	-22RH	-22RHN
	2	-22T	-22TN	-22TE	-22TEN	-22TH	-22THN
M24	0.75	-23L	-23LN	-23LE	-23LEN	-23LH	-23LHN
	1	-23P	-23PN	-23PE	-23PEN	-23PH	-23PHN
	0.75	-24L	-24LN	-24LE	-24LEN	-24LH	-24LHN
	1	-24P	-24PN	-24PE	-24PEN	-24PH	-24PHN
M25	1.25	-24Q	-24QN	-24QE	-24QEN	-24QH	-24QHN
	1.5	-24R	-24RN	-24RE	-24REN	-24RH	-24RHN
	2	-24T	-24TN	-24TE	-24TEN	-24TH	-24THN
	0.75	-25L	-25LN	-25LE	-25LEN	-25LH	-25LHN
M26	1	-25P	-25PN	-25PE	-25PEN	-25PH	-25PHN
	1.5	-25R	-25RN	-25RE	-25REN	-25RH	-25RHN
	2	-25T	-25TN	-25TE	-25TEN	-25TH	-25THN
M26	0.75	-26L	-26LN	-26LE	-26LEN	-26LH	-26LHN
	1	-26P	-26PN	-26PE	-26PEN	-26PH	-26PHN
	1.5	-26R	-26RN	-26RE	-26REN	-26RH	-26RHN
	2	-26T	-26TN	-26TE	-26TEN	-26TH	-26THN

To be continued

Continued from previous page

Size (mm)		Code (4129) *					
Nominal diameter	Pitch	Class 6g		Class 6e		Class 6h	
		GO	NOGO	GO	NOGO	GO	NOGO
M27	0.75	-27L	-27LN	-27LE	-27LEN	-27LH	-27LHN
	1	-27P	-27PN	-27PE	-27PEN	-27PH	-27PHN
	1.5	-27R	-27RN	-27RE	-27REN	-27RH	-27RHN
	2	-27T	-27TN	-27TE	-27TEN	-27TH	-27THN
M28	0.75	-28L	-28LN	-28LE	-28LEN	-28LH	-28LHN
	1	-28P	-28PN	-28PE	-28PEN	-28PH	-28PHN
	1.5	-28R	-28RN	-28RE	-28REN	-28RH	-28RHN
	2	-28T	-28TN	-28TE	-28TEN	-28TH	-28THN
M29	0.75	-29L	-29LN	-29LE	-29LEN	-29LH	-29LHN
	1	-29P	-29PN	-29PE	-29PEN	-29PH	-29PHN
M30	0.75	-30L	-30LN	-30LE	-30LEN	-30LH	-30LHN
	1	-30P	-30PN	-30PE	-30PEN	-30PH	-30PHN
	1.5	-30R	-30RN	-30RE	-30REN	-30RH	-30RHN
	2	-30T	-30TN	-30TE	-30TEN	-30TH	-30THN
M31	3	-30V	-30VN	-30VE	-30VEN	-30VH	-30VHN
	0.75	-31L	-31LN	-31LE	-31LEN	-31LH	-31LHN
	M32	1	-32L	-32LN	-32LE	-32LEN	-32LH
1		-32P	-32PN	-32PE	-32PEN	-32PH	-32PHN
1.5		-32R	-32RN	-32RE	-32REN	-32RH	-32RHN
2		-32T	-32TN	-32TE	-32TEN	-32TH	-32THN
M33	0.75	-33L	-33LN	-33LE	-33LEN	-33LH	-33LHN
	1	-33P	-33PN	-33PE	-33PEN	-33PH	-33PHN
	1.5	-33R	-33RN	-33RE	-33REN	-33RH	-33RHN
	2	-33T	-33TN	-33TE	-33TEN	-33TH	-33THN
M34	3	-33V	-33VN	-33VE	-33VEN	-33VH	-33VHN
	1	-34P	-34PN	-34PE	-34PEN	-34PH	-34PHN
	1.5	-34R	-34RN	-34RE	-34REN	-34RH	-34RHN
M35	2	-34T	-34TN	-34TE	-34TEN	-34TH	-34THN
	1	-35P	-35PN	-35PE	-35PEN	-35PH	-35PHN
	1.5	-35R	-35RN	-35RE	-35REN	-35RH	-35RHN
M36	2	-35T	-35TN	-35TE	-35TEN	-35TH	-35THN
	1	-36P	-36PN	-36PE	-36PEN	-36PH	-36PHN
	1.5	-36R	-36RN	-36RE	-36REN	-36RH	-36RHN
	2	-36T	-36TN	-36TE	-36TEN	-36TH	-36THN
M38	3	-36V	-36VN	-36VE	-36VEN	-36VH	-36VHN
	1	-38P	-38PN	-38PE	-38PEN	-38PH	-38PHN
	1.5	-38R	-38RN	-38RE	-38REN	-38RH	-38RHN
M39	2	-38T	-38TN	-38TE	-38TEN	-38TH	-38THN
	1	-39P	-39PN	-39PE	-39PEN	-39PH	-39PHN
	1.5	-39R	-39RN	-39RE	-39REN	-39RH	-39RHN
	2	-39T	-39TN	-39TE	-39TEN	-39TH	-39THN
M40	3	-39V	-39VN	-39VE	-39VEN	-39VH	-39VHN
	1.5	-40R	-40RN	-40RE	-40REN	-40RH	-40RHN
	2	-40T	-40TN	-40TE	-40TEN	-40TH	-40THN
M42	3	-40V	-40VN	-40VE	-40VEN	-40VH	-40VHN
	1.5	-42R	-42RN	-42RE	-42REN	-42RH	-42RHN
	2	-42T	-42TN	-42TE	-42TEN	-42TH	-42THN
M45	3	-42V	-42VN	-42VE	-42VEN	-42VH	-42VHN
	1.5	-45R	-45RN	-45RE	-45REN	-45RH	-45RHN
	2	-45T	-45TN	-45TE	-45TEN	-45TH	-45THN
M48	3	-45V	-45VN	-45VE	-45VEN	-45VH	-45VHN
	1.5	-48R	-48RN	-48RE	-48REN	-48RH	-48RHN
	2	-48T	-48TN	-48TE	-48TEN	-48TH	-48THN
M50	3	-48V	-48VN	-48VE	-48VEN	-48VH	-48VHN
	1.5	-50R	-50RN	-50RE	-50REN	-50RH	-50RHN
	2	-50T	-50TN	-50TE	-50TEN	-50TH	-50THN
	3	-50V	-50VN	-50VE	-50VEN	-50VH	-50VHN

To be continued



Continued from previous page

Size (mm)		Code (4129) *					
Nominal diameter	Pitch	Class 6g		Class 6e		Class 6h	
		GO	NOGO	GO	NOGO	GO	NOGO
M52	1.5	-52R	-52RN	-52RE	-52REN	-52RH	-52RHN
	2	-52T	-52TN	-52TE	-52TEN	-52TH	-52THN
	3	-52V	-52VN	-52VE	-52VEN	-52VH	-52VHN
	4	-52X	-52XN	-52XE	-52XEN	-52XH	-52XHN
M55	1.5	-55R	-55RN	-55RE	-55REN	-55RH	-55RHN
	2	-55T	-55TN	-55TE	-55TEN	-55TH	-55THN
	3	-55V	-55VN	-55VE	-55VEN	-55VH	-55VHN
	4	-55X	-55XN	-55XE	-55XEN	-55XH	-55XHN
M56	1.5	-56R	-56RN	-56RE	-56REN	-56RH	-56RHN
	2	-56T	-56TN	-56TE	-56TEN	-56TH	-56THN
	3	-56V	-56VN	-56VE	-56VEN	-56VH	-56VHN
	4	-56X	-56XN	-56XE	-56XEN	-56XH	-56XHN
M58	1.5	-58R	-58RN	-58RE	-58REN	-58RH	-58RHN
	2	-58T	-58TN	-58TE	-58TEN	-58TH	-58THN
	3	-58V	-58VN	-58VE	-58VEN	-58VH	-58VHN
	4	-58X	-58XN	-58XE	-58XEN	-58XH	-58XHN
M60	1.5	-60R	-60RN	-60RE	-60REN	-60RH	-60RHN
	2	-60T	-60TN	-60TE	-60TEN	-60TH	-60THN
	3	-60V	-60VN	-60VE	-60VEN	-60VH	-60VHN
	4	-60X	-60XN	-60XE	-60XEN	-60XH	-60XHN



AMERICAN STANDARD THREAD PLUG GAGES

- Supplied with Go and No-Go gages together
- Standard ANSI/ASME B1.2
- Supplied with manufacturer inspection certificate



4131-102

Size	Code		Size	Code		Size	Code	
	Class 2B	Class 3B		Class 2B	Class 3B		Class 2B	Class 3B
No. 0-80UNF	4131-02	4131-02B	5/16-18UNC	4131-5D1	4131-5D1B	13/16-20UNEF	4131-13D3	4131-13D3B
No. 1-64UNC	4131-11	4131-11B	5/16-24UNF	4131-5D2	4131-5D2B	7/8-9UNC	4131-7C1	4131-7C1B
No. 1-72UNF	4131-12	4131-12B	5/16-32UNEF	4131-5D3	4131-5D3B	7/8-14UNF	4131-7C2	4131-7C2B
No. 2-56UNC	4131-21	4131-21B	3/8-16UNC	4131-3C1	4131-3C1B	7/8-16UN	4131-7C516	4131-7C516B
No. 2-64UNF	4131-22	4131-22B	3/8-24UNF	4131-3C2	4131-3C2B	7/8-20UNEF	4131-7C3	4131-7C3B
No. 3-48UNC	4131-31	4131-31B	3/8-32UNEF	4131-3C3	4131-3C3B	15/16-20UNEF	4131-15D3	4131-15D3B
No. 3-56UNF	4131-32	4131-32B	7/16-14UNC	4131-7D1	4131-7D1B	1-8UNC	4131-2A1	4131-2A1B
No. 4-40UNC	4131-41	4131-41B	7/16-20UNF	4131-7D2	4131-7D2B	1-12UNF	4131-2A2	4131-2A2B
No. 4-48UNF	4131-42	4131-42B	7/16-28UNEF	4131-7D3	4131-7D3B	1-14UNS	4131-2A514	4131-2A514B
No. 5-40UNC	4131-51	4131-51B	1/2-13UNC	4131-1A1	4131-1A1B	1-20UNEF	4131-2A3	4131-2A3B
No. 5-44UNF	4131-52	4131-52B	1/2-20UNF	4131-1A2	4131-1A2B	1-32UN	4131-2A532	4131-2A532B
No. 6-32UNC	4131-61	4131-61B	1/2-28UNEF	4131-1A3	4131-1A3B	1 1/16-12UN	4131-1E512	4131-1E512B
No. 6-40UNF	4131-62	4131-62B	9/16-12UNC	4131-9D1	4131-9D1B	1 1/16-18UNEF	4131-1E3	4131-1E3B
No. 8-32UNC	4131-81	4131-81B	9/16-18UNF	4131-9D2	4131-9D2B	1 1/8-7UNC	4131-1F1	4131-1F1B
No. 8-36UNF	4131-82	4131-82B	9/16-24UNEF	4131-9D3	4131-9D3B	1 1/8-8UN	4131-1F58	4131-1F58B
No. 10-24UNC	4131-101	4131-101B	5/8-11UNC	4131-5C1	4131-5C1B	1 1/8-12UNF	4131-1F2	4131-1F2B
No. 10-32UNF	4131-102	4131-102B	5/8-18UNF	4131-5C2	4131-5C2B	1 1/8-18UNEF	4131-1F3	4131-1F3B
No. 12-24UNC	4131-121	4131-121B	5/8-24UNEF	4131-5C3	4131-5C3B	1 3/16-12UN	4131-3E512	4131-3E512B
No. 12-28UNF	4131-122	4131-122B	11/16-16UN	4131-11D516	4131-11D516B	1 3/16-18UNEF	4131-3E3	4131-3E3B
No. 12-32UNEF	4131-123	4131-123B	11/16-24UNEF	4131-11D3	4131-11D3B	1 1/4-7UNC	4131-1G1	4131-1G1B
1/4-20UNC	4131-1B1	4131-1B1B	3/4-10UNC	4131-3B1	4131-3B1B	1 1/4-8UN	4131-1G58	4131-1G58B
1/4-28UNF	4131-1B2	4131-1B2B	3/4-16UNF	4131-3B2	4131-3B2B	1 1/4-12UNF	4131-1G2	4131-1G2B
1/4-32UNEF	4131-1B3	4131-1B3B	3/4-20UNEF	4131-3B3	4131-3B3B	1 1/4-18UNEF	4131-1G3	4131-1G3B
1/4-36UNS	4131-1B4	4131-1B4B	13/16-16UN	4131-13D516	4131-13D516B	1 5/16-12UN	4131-5E512	4131-5E512B

AMERICAN STANDARD THREAD RING GAGES



- Standard ANSI/ASME B1.2
- Class 2A
- Supplied with manufacturer inspection certificate

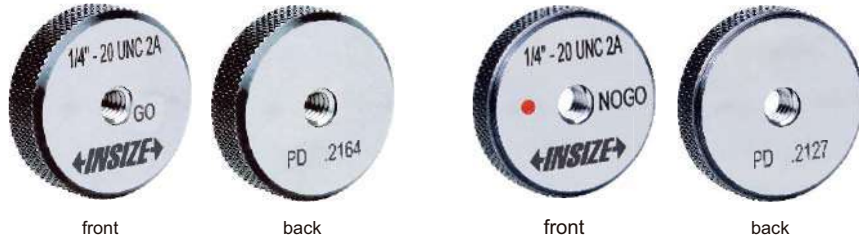

4121-1B1

4121-1B1N

Size	Code	
	GO	NOGO
No. 4-40UNC	4121-41	4121-41N
No. 4-48UNF	4121-42	4121-42N
No. 5-40UNC	4121-51	4121-51N
No. 5-44UNF	4121-52	4121-52N
No. 6-32UNC	4121-61	4121-61N
No. 6-40UNF	4121-62	4121-62N
No. 8-32UNC	4121-81	4121-81N
No. 8-36UNF	4121-82	4121-82N
No. 10-24UNC	4121-101	4121-101N
No. 10-32UNF	4121-102	4121-102N
No. 12-24UNC	4121-121	4121-121N
No. 12-28UNF	4121-122	4121-122N
No. 12-32UNEF	4121-123	4121-123N
1/4-20UNC	4121-1B1	4121-1B1N
1/4-28UNF	4121-1B2	4121-1B2N
1/4-32UNEF	4121-1B3	4121-1B3N
1/4-36UNS	4121-1B4	4121-1B4N
5/16-18UNC	4121-5D1	4121-5D1N
5/16-24UNF	4121-5D2	4121-5D2N
5/16-32UNEF	4121-5D3	4121-5D3N
3/8-16UNC	4121-3C1	4121-3C1N
3/8-24UNF	4121-3C2	4121-3C2N

Size	Code	
	GO	NOGO
3/8-32UNEF	4121-3C3	4121-3C3N
7/16-14UNC	4121-7D1	4121-7D1N
7/16-20UNF	4121-7D2	4121-7D2N
7/16-28UNEF	4121-7D3	4121-7D3N
1/2-13UNC	4121-1A1	4121-1A1N
1/2-20UNF	4121-1A2	4121-1A2N
1/2-28UNEF	4121-1A3	4121-1A3N
9/16-12UNC	4121-9D1	4121-9D1N
9/16-18UNF	4121-9D2	4121-9D2N
9/16-24UNEF	4121-9D3	4121-9D3N
5/8-11UNC	4121-5C1	4121-5C1N
5/8-18UNF	4121-5C2	4121-5C2N
5/8-24UNEF	4121-5C3	4121-5C3N
11/16-16UN	4121-11D516	4121-11D516N
11/16-24UNEF	4121-11D3	4121-11D3N
3/4-10UNC	4121-3B1	4121-3B1N
3/4-16UNF	4121-3B2	4121-3B2N
3/4-20UNEF	4121-3B3	4121-3B3N
13/16-16UN	4121-13D516	4121-13D516N
13/16-20UNEF	4121-13D3	4121-13D3N
7/8-9UNC	4121-7C1	4121-7C1N
7/8-14UNF	4121-7C2	4121-7C2N

Size	Code	
	GO	NOGO
7/8-16UN	4121-7C516	4121-7C516N
7/8-20UNEF	4121-7C3	4121-7C3N
15/16-20UNEF	4121-15D3	4121-15D3N
1-8UNC	4121-2A1	4121-2A1N
1-12UNF	4121-2A2	4121-2A2N
1-14UNS	4121-2A514	4121-2A514N
1-20UNEF	4121-2A3	4121-2A3N
1-32UN	4121-2A532	4121-2A532N
1 1/16-12UN	4121-1E512	4121-1E512N
1 1/16-18UNEF	4121-1E3	4121-1E3N
1 1/8-7UNC	4121-1F1	4121-1F1N
1 1/8-8UN	4121-1F58	4121-1F58N
1 1/8-12UNF	4121-1F2	4121-1F2N
1 1/8-18UNEF	4121-1F3	4121-1F3N
1 3/16-12UN	4121-3E512	4121-3E512N
1 3/16-18UNEF	4121-3E3	4121-3E3N
1 1/4-7UNC	4121-1G1	4121-1G1N
1 1/4-8UN	4121-1G58	4121-1G58N
1 1/4-12UNF	4121-1G2	4121-1G2N
1 1/4-18UNEF	4121-1G3	4121-1G3N
1 5/16-12UN	4121-5E512	4121-5E512N

9

STEEL BALL SET



- To measure angle and diameter of taper holes
- Each size has a pair of steel ball
- Material: tool steel
- Hardness: HRC63
- Diameter accuracy: $\pm 2\mu\text{m}$
- Roundness: $0.6\mu\text{m}$
- Supplied with manufacturer inspection certificate



4168-S25

Calculate angle (α) and diameter (D_{max}) according to the ball diameter (d_1 , d_2), height (A) and depth (B)

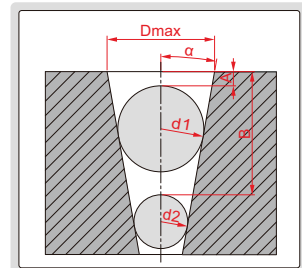

Code	Diameter	Steel balls per set
4168-S25	1, 2, 3, 4, 5, 6, 7, 8, 9, 10, 11, 12, 13, 14, 15, 16, 17, 18, 19, 20, 21, 22, 23, 24, 25mm	25 pairs

IP54
WATERPROOF

ABSOLUTE
LEVEL

AUTOMATIC
BACKLIGHT

WATERPROOF DIGITAL PROTRACTOR (HEAVY DUTY)

- Suitable for setting horizontal and vertical mitre angles of cutting machines
- Buttons: ON/OFF, HOLD/SUP, SPR/CNR/MTR/BVL
- IP54 dust/waterproof
- With transverse and longitudinal vials
- 2xAAA batteries
- Absolute level, zero setting is not needed when batteries are replaced
- Backlight turns off in one minute after reading is stable, automatic power off in 5 minutes



2174-225

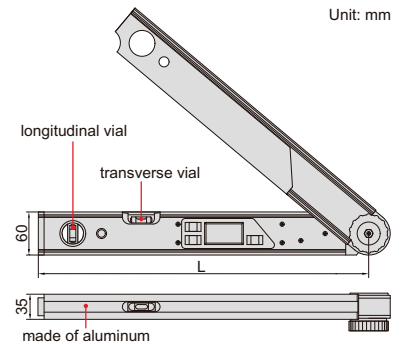

Unit: mm

Code	Size (L)	Range	Resolution	Accuracy
2174-225	460mm	0-225°	0.05°	±0.10°

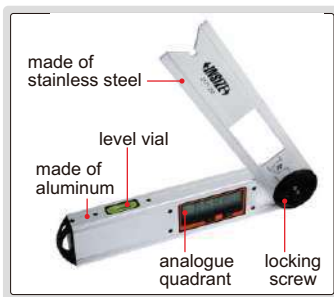
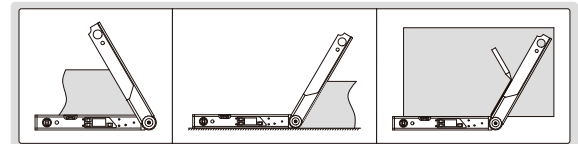

- Buttons: on/off, hold (keep the reading), zero, ABS (absolute and incremental measurement)
- Fix the locking screw at 4 positions for different measuring ranges: 0°~225°, -225°~0°, -45°~180°, -180°~45°
- Remove the locking screw for 360° range
- With level vial
- Battery CR2032, automatic power off

Code	Size (L)	Range	Resolution	Accuracy
2171-250	250mm	0 - 360°	0.05°	±0.15°



2171-250

DIGITAL PROTRACTOR

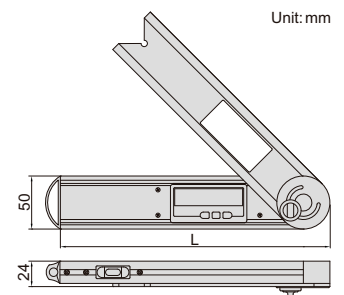

Unit: mm

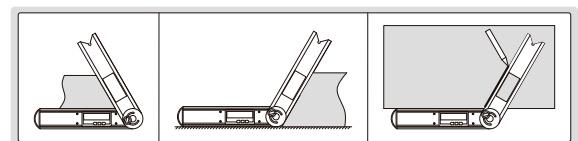

DIGITAL PROTRACTORS

- Buttons: on/off, zero
- With clamping screw to lock the blades
- Graduation of blade: 1mm and 1/32"
- Made of stainless steel
- CR2032 battery
- Automatic power off

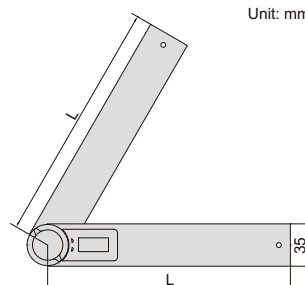
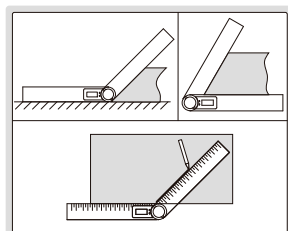

Unit: mm



2176-200

Code	Size (L)	Range	Resolution	Accuracy
2176-200	200mm	0-360°	0.1°	±0.3°
2176-300	300mm	0-360°	0.1°	±0.3°

PROTRACTOR (ECONOMIC TYPE)

- Graduation: 1°
- Made of stainless steel
- With clamping screw

Code	Size	Range	Accuracy
4780-85A	90x154mm	0-180°	±0.5°



4780-85A

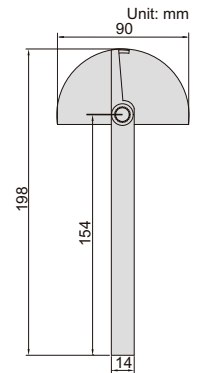

PROTRACTORS

- Graduation: 1°
- Made of stainless steel (4799-1300 is made of carbon steel)
- Satin chrome plated scale
- With clamping screw

Code	Size (AxB)	Range	Accuracy	L	C
4799-180	80x120mm	0-180°	±0.3°	168	11
4799-1120	120x150mm	0-180°	±0.3°	220	14
4799-1150	150x200mm	0-180°	±0.3°	285	16
4799-1200	200x300mm	0-180°	±0.3°	413	20
4799-1300	300x500mm	0-180°	±0.3°	675	30

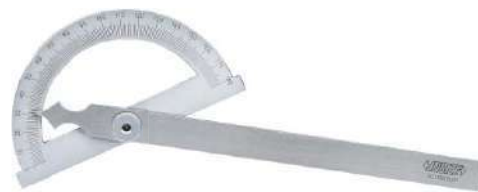

4799-180

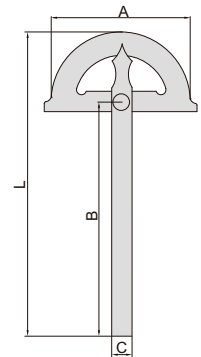

PROTRACTORS

- Graduation: 1°
- Made of carbon steel
- Satin chrome plated
- With clamping screw
- The blade is moveable

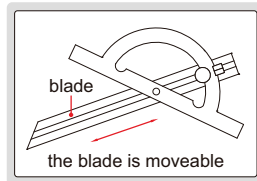

Code	Size (AxB)	Range	Accuracy	C
4797-100	100x150mm	10-170°	±0.3°	18mm
4797-150	150x300mm	10-170°	±0.3°	22mm
4797-200	200x400mm	10-170°	±0.3°	24mm
4797-250	250x500mm	10-170°	±0.3°	28mm
4797-300	300x600mm	10-170°	±0.3°	32mm



4797-100

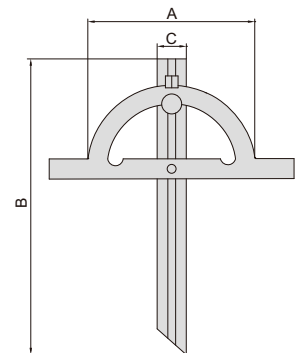

PROTRACTOR



2374-320

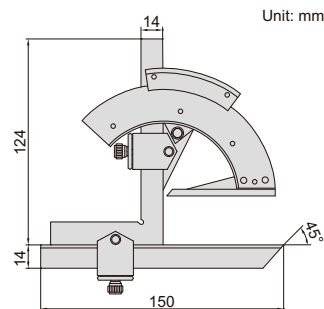

- Made of stainless steel
- Satin chrome plated scale

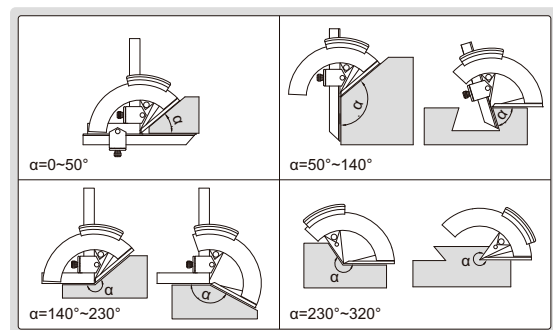

Code	Range	Graduation	Accuracy
2374-320	0-320°	2'	±2'

UNIVERSAL PROTRACTOR

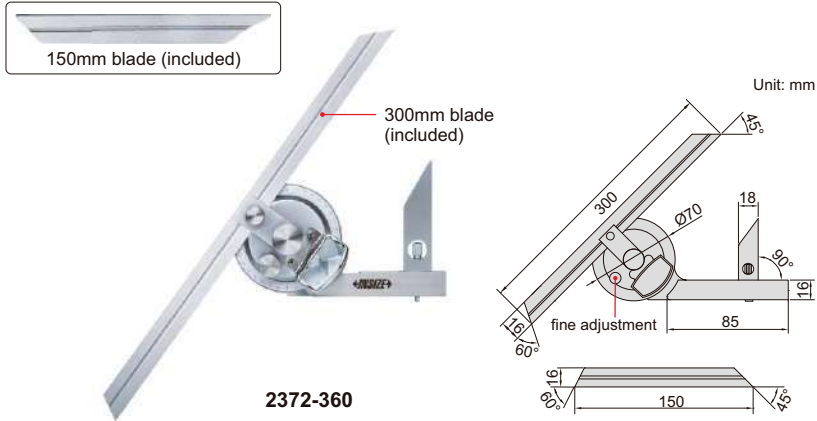

2372-360

clamp for height gages (optional)

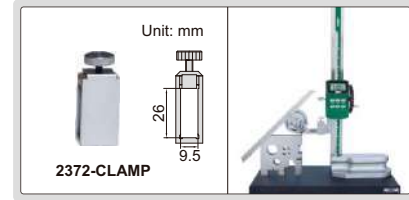

- Parallax-free reading
- Made of stainless steel
- Optional accessory: clamp (code 2372-CLAMP), suitable for height gages 1156, 1351 and 1250

Code	Range	Graduation	Accuracy
2372-360	0-360°	5'	±5'

DIAL PROTRACTOR

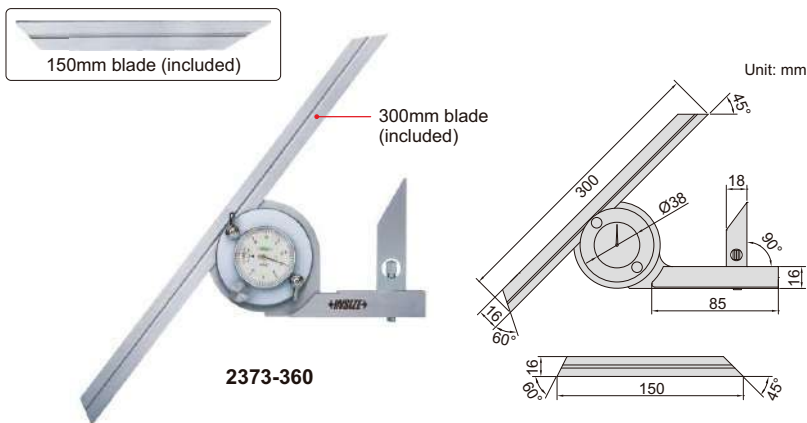

2373-360

clamp for height gages (optional)

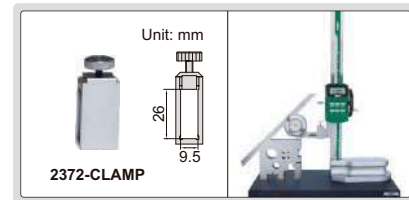

- Made of stainless steel
- Optional accessory: clamp (code 2372-CLAMP), suitable for height gages 1156, 1351 and 1250

Code	Range	Graduation	Accuracy
2373-360	0-360°	5'	±5'

10

DIGITAL PROTRACTOR

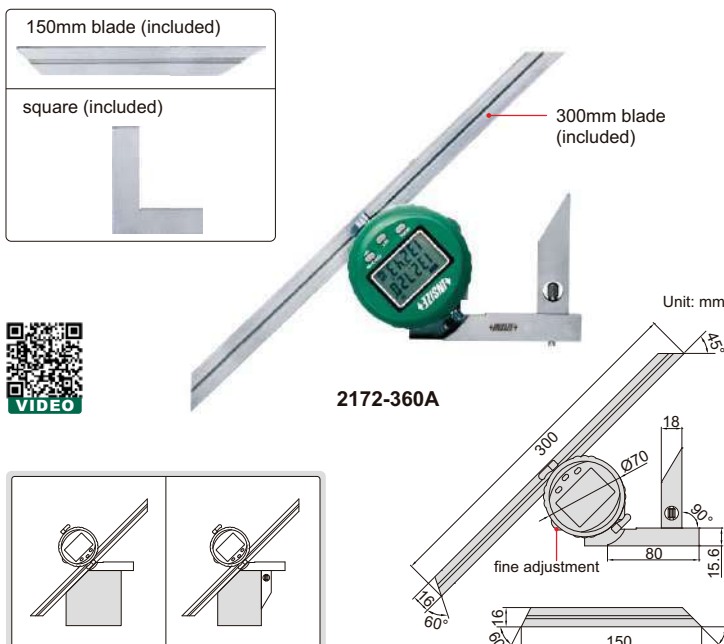

2172-360A

clamp for height gages (optional)

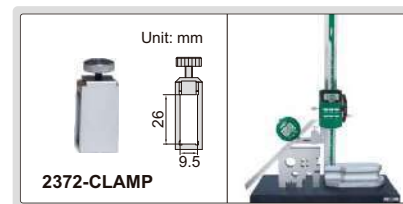

DATA OUTPUT

- Display in degree (for example 32.655°) and degree/minute/second (for example 32°39'30")
- SET button: preset the reading, change measuring direction
- MODE button: choose 0~90°, 0~180° or 0~360° display
- ZERO/ON/OFF button: zero and power on/off
- Battery CR2032, automatic power off
- Data output
- Supplied with square to set 90°
- Made of stainless steel
- Optional accessory: data output cable (code 7315-, 7302-, 7305-), clamp (code 2372-CLAMP), suitable for height gages 1156, 1351 and 1250

Code	Range	Resolution	Accuracy
2172-360A	0-360°	10"/0.005°	±5'

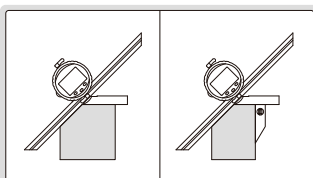

PERPENDICULARITY TESTERS

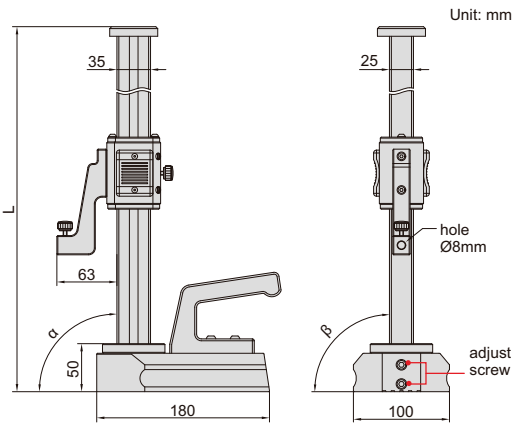

dial test indicator is optional

4770-300

- Optional accessory: dial test indicators (graduation: 1μm or 2μm)

Code	Range (H)	Perpendicularity (α)	Side perpendicularity (β)	L
4770-300	0-300mm	3μm	10μm	460mm
4770-600	0-600mm	5μm	20μm	760mm

10

CYLINDER SQUARES



4710-200

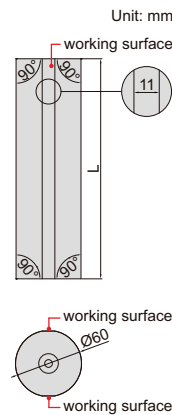

inspect 90° internal and external angles

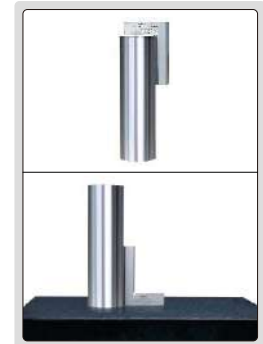

- Made of special alloy steel, hardness HRC58~60
- The handle can be removed

Code	Length (L)	Squareness
4710-200*	200mm	1μm
4710-300*	300mm	2μm

* Supplied with manufacturer inspection certificate

GRANITE SQUARES

CUSTOM-MADE
SUPPLY SPECIAL SIZES ACCORDING
TO CUSTOMER'S REQUEST



4141-250

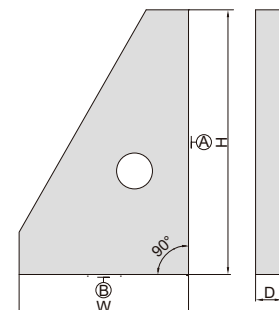

Code	Size (HxW)	Flatness of A	Flatness of B	Squareness of A to B	D
4141-250	250x160mm	1μm	1μm	2μm	25mm
4141-400	400x250mm	1.5μm	1μm	3μm	40mm
4141-630	630x400mm	2μm	1.5μm	4μm	63mm

CUSTOM-MADE
SUPPLY SPECIAL SIZES ACCORDING
TO CUSTOMER'S REQUEST

GRANITE SQUARE

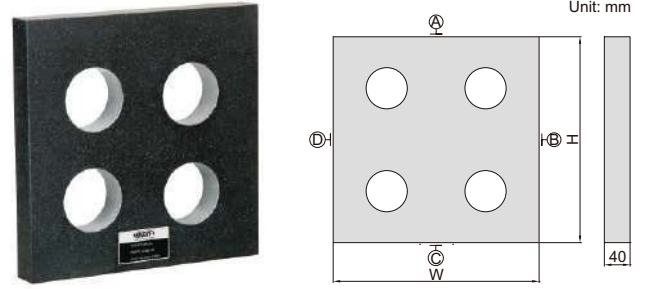

4144-315

Code	Size (HxW)	Flatness of A, B, C and D	Squareness and parallelism between A, B, C and D
4144-315	315x315mm	1.1µm	2.6µm

GRANITE SQUARE WITH V GROOVE

- Parallelism and squareness of A, B, C, D, E and F: 6µm
- Parallelism and squareness of V groove to A, B, C, D, E and F: 6µm

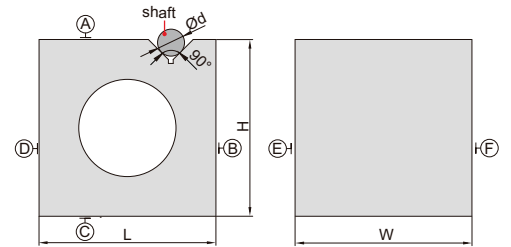

4142-200

Code	Size (LxWxH)	Range of shaft (Ød)
4142-200	200x200x200mm	9-70mm

90° BEVELED EDGE SQUARES

- Satin chrome plating
- Beveled edges for inside and outside measurements
- Made of hardened stainless steel

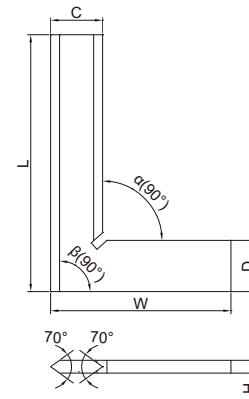

4790-0100

Code	Size (LxW)	Squareness		C	D	H
		Inside (α)	Outside (β)			
4790-050	50x40mm	2.4µm	2.5µm	13	13	4
4790-075	75x50mm	2.6µm	2.8µm	15	15	4
4790-0100	100x70mm	2.8µm	3.0µm	20	20	5
4790-0150	150x100mm	3.2µm	3.5µm	30	30	6
4790-0200	200x130mm	3.7µm	4.0µm	34	34	7
4790-0250	250x165mm	4.2µm	4.5µm	35	35	7
4790-0300	300x200mm	4.6µm	5.0µm	40	40	8

Code	Size (LxW)	Squareness		C	D	H
		Inside (α)	Outside (β)			
4790-500	50x40mm	6µm	6µm	13	13	4
4790-750	75x50mm	6µm	7µm	15	15	4
4790-1000	100x70mm	7µm	7µm	20	20	5
4790-1500	150x100mm	7µm	8µm	30	30	6
4790-2000	200x130mm	8µm	9µm	34	34	7
4790-2500	250x165mm	9µm	10µm	35	35	7
4790-3000	300x200mm	10µm	11µm	40	40	8

90° TOOL MAKER SQUARES

- DIN875 grade 00
- Beveled edge for inside measurement
- Made of hardened stainless steel

Code	Size (LxW)	Squareness		C	D	H
		Inside (α)	Outside (β)			
4794-025	25x20mm	2.2 μ m	2.3 μ m	4	6.5	3.5
4794-040	40x28mm	2.3 μ m	2.4 μ m	5.5	8.5	3.5

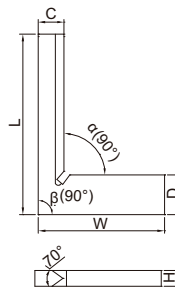

4794-040

90° FLAT EDGE SQUARES

- DIN875 grade 0
- Made of hardened stainless steel

Code	Size (LxW)	Squareness		C	D	H
		Inside (α)	Outside (β)			
4791-50	50x40mm	6 μ m	6 μ m	15	15	4
4791-75	75x50mm	6 μ m	7 μ m	15	15	4
4791-100	100x70mm	7 μ m	7 μ m	20	20	5
4791-150	150x100mm	7 μ m	8 μ m	30	30	6
4791-200	200x130mm	8 μ m	9 μ m	30	30	7
4791-250	250x165mm	9 μ m	10 μ m	35	35	7
4791-300	300x200mm	10 μ m	11 μ m	40	40	8

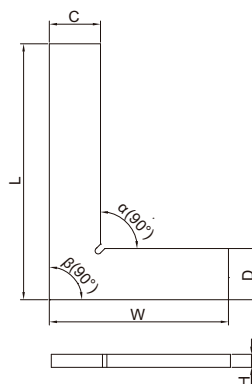

4791-100

90° FLAT EDGE SQUARES WITH WIDE BASE

- DIN875 grade 0
- Made of hardened stainless steel

Code	Size (LxW)	Squareness		C	D	H	E
		Inside (α)	Outside (β)				
4793-50	50x40mm	6 μ m	6 μ m	13	13	4	13
4793-75	75x50mm	6 μ m	7 μ m	15	15	4	15
4793-100	100x70mm	7 μ m	7 μ m	20	20	5	20
4793-150	150x100mm	7 μ m	8 μ m	30	30	6	30
4793-200	200x130mm	8 μ m	9 μ m	30	30	7	30
4793-250	250x165mm	9 μ m	10 μ m	35	35	7	35
4793-300	300x200mm	10 μ m	11 μ m	40	40	8	40

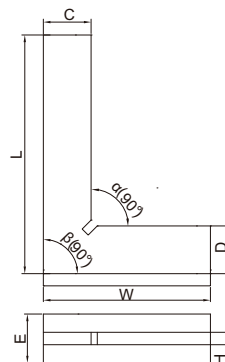

4793-100

90° FLAT EDGE SQUARES WITH WIDE BASE

- DIN875 grade 0
- Made of hardened stainless steel

Code	Size (LxW)	Squareness		C	D	H	E
		Inside (α)	Outside (β)				
4792-50	50x40mm	6 μ m	6 μ m	12	12	3	10
4792-75	75x50mm	6 μ m	7 μ m	14	14	3	10
4792-100	100x70mm	7 μ m	7 μ m	18	18	3	10
4792-150	150x100mm	8 μ m	8 μ m	22	22	4	12
4792-200	200x130mm	9 μ m	9 μ m	25	25	4	12

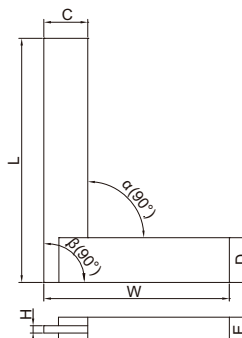

4792-100



90° BEVELED EDGE SQUARES WITH WIDE BASE

- DIN875 grade 0
- Beveled edges for inside and outside measurements
- Made of hardened stainless steel

Code	Size (LxW)	Squareness		C	D	H	E
		Inside (α)	Outside (β)				
4795-50	50x40mm	6 μ m	6 μ m	12	12	3	10
4795-75	75x50mm	6 μ m	7 μ m	14	14	3	10
4795-100	100x70mm	7 μ m	7 μ m	18	18	3	10
4795-150	150x100mm	8 μ m	8 μ m	22	22	4	12
4795-200	200x130mm	9 μ m	9 μ m	25	25	4	12

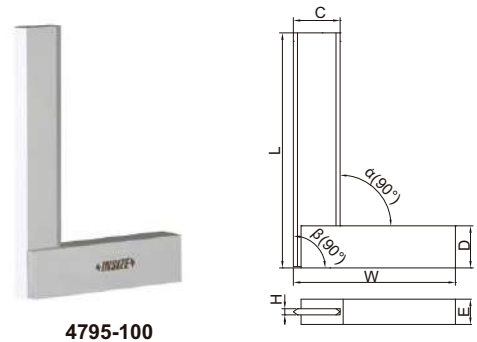

4795-100

ATTENTION: NO ANTI-RUST TREATMENT, NOT HARDEND

ATTENTION: LOW ACCURACY

MACHINIST SQUARES WITH WIDE BASE (ECONOMIC TYPE)

- DIN875 grade 2
- Made of carbon steel, no anti-rust treatment, not hardend

Code	Size (LxW)	Squareness		C	D	H	E
		Inside (α)	Outside (β)				
4707-50	50x40mm	24 μ m	25 μ m	16	12	3	9
4707-75	75x50mm	26 μ m	28 μ m	16	16	3	9
4707-100	100x70mm	28 μ m	30 μ m	19	19	3	12
4707-150	150x100mm	33 μ m	35 μ m	25	25	3	16
4707-200	200x130mm	37 μ m	40 μ m	30	32	4	16
4707-250	250x165mm	42 μ m	45 μ m	30	32	4	19
4707-300	300x200mm	47 μ m	50 μ m	32	32	4	19
4707-400	400x250mm	56 μ m	60 μ m	38	38	5	22
4707-500	500x300mm	65 μ m	70 μ m	45	50	6	25
4707-600	600x350mm	75 μ m	80 μ m	50	50	6	30
4707-750	750x400mm	90 μ m	95 μ m	55	55	6	50
4707-900	900x500mm	103 μ m	110 μ m	65	75	9	50
4707-1000	1000x550mm	113 μ m	120 μ m	65	75	9	50

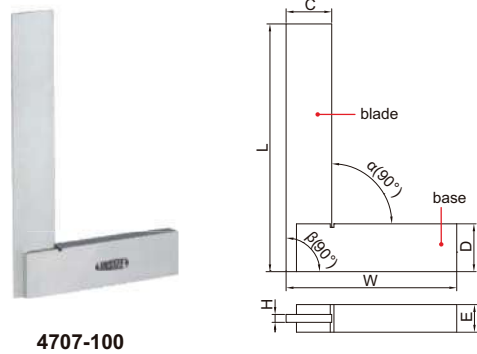

4707-100

10

MAGNALIUM 90° FLAT EDGE SQUARES WITH WIDE BASE

- DIN875 grade 1
- Made of magnalium, light weight, non-deform, no rusty

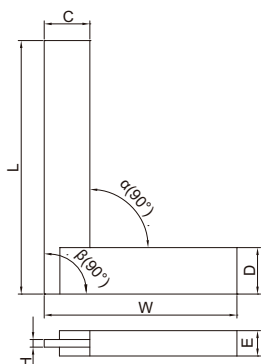

Code	Size (LxW)	Squareness		C	D	H	E	Weight
		Inside (α)	Outside (β)					
4705-630	630x400mm	30 μ m	32 μ m	40	60	18.2	40	5kg
4705-800	800x500mm	37 μ m	40 μ m	50	75	25	50	7kg
4705-1000	1000x630mm	45 μ m	48 μ m	50	75	25	50	9kg
4705-1250	1250x800mm	53 μ m	56 μ m	60	75	40	50	11kg
4705-1600	1600x1000mm	69 μ m	72 μ m	60	75	40	50	13kg
4705-2000	2000x1250mm	85 μ m	88 μ m	60	75	40	50	15kg
4705-2600	2600x1500mm	109 μ m	112 μ m	60	75	40	50	20kg

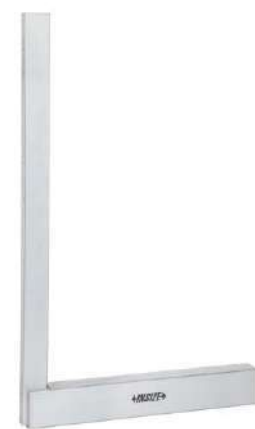

4705-630

TRY SQUARE

- Graduation: 1mm
- Stainless steel blade, aluminum base

Code	Size (LxW)	Squareness	
		Inside (α)	Outside (β)
2275-300	300x170mm	0.5mm	0.5mm



2275-300

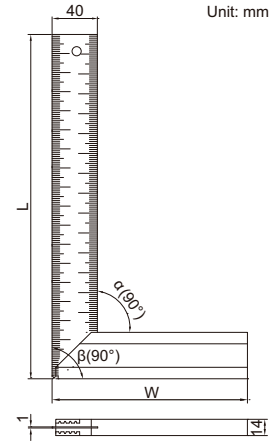

Unit: mm

ADJUSTABLE SQUARE

- The straight edge can move and can be locked by the clamping screw
- Made of hardened stainless steel

Code	Squareness (a, b, c, d)
4701-1	7 μ m

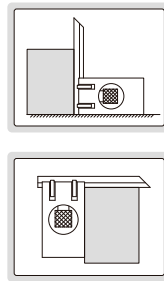

4701-1

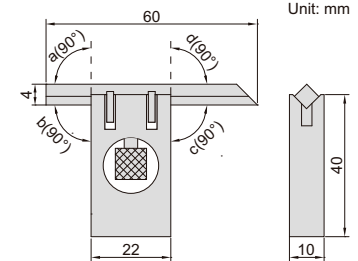

Unit: mm

45° SQUARES

- Made of hardened stainless steel

Code	Size (LxW)	Accuracy (mm)			C	D	H
		Inside (α)	Outside (β)				
4745-1120	120x80mm	29 μ m	32 μ m	20	20	5	
4745-1150	150x100mm	32 μ m	35 μ m	20	20	5	
4745-1200	200x130mm	36 μ m	40 μ m	25	25	5	



4745-1120

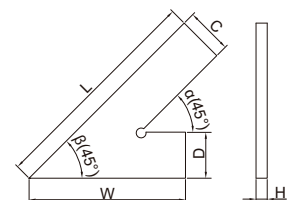

45° SQUARES WITH WIDE BASE

- Made of hardened stainless steel

Code	Size (LxW)	Accuracy (mm)				C	D	H	E
		Inside (α)	Outside (β)						
4747-120	120x80mm	29 μ m	33 μ m	20	20	5	20		
4747-150	150x100mm	32 μ m	36 μ m	20	20	5	20		
4747-200	200x130mm	36 μ m	41 μ m	25	25	5	25		



4747-120

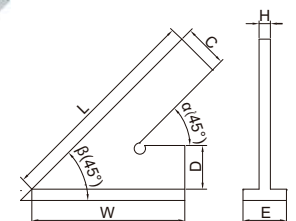

60° SQUARES

- Made of hardened stainless steel

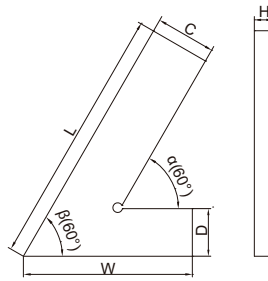

(mm)

Code	Size (LxW)	Accuracy		C	D	H
		Inside (α)	Outside (β)			
4760-1120	120x80mm	30 μ m	32 μ m	20	20	5
4760-1150	150x100mm	32 μ m	35 μ m	20	20	5
4760-1200	200x130mm	37 μ m	40 μ m	25	25	5



4760-1120

60° SQUARES WITH WIDE BASE

10

- Made of hardened stainless steel

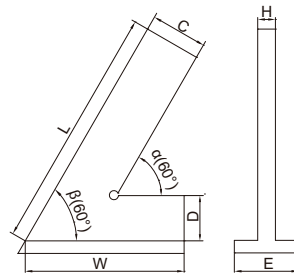

(mm)

Code	Size (LxW)	Accuracy		C	D	H	E
		Inside (α)	Outside (β)				
4762-120	120x80mm	30 μ m	33 μ m	20	20	5	20
4762-150	150x100mm	33 μ m	36 μ m	20	20	5	20
4762-200	200x130mm	37 μ m	41 μ m	25	25	5	25



4762-120

120° SQUARES

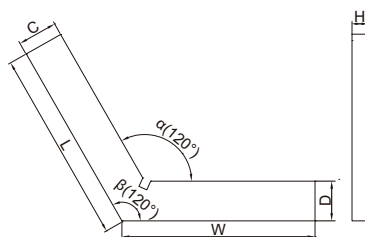

(mm)

Code	Size (LxW)	Accuracy		C	D	H
		Inside (α)	Outside (β)			
4706-150	50x50mm	24 μ m	25 μ m	15	15	5
4706-175	75x75mm	26 μ m	28 μ m	20	20	5
4706-1100	100x100mm	29 μ m	30 μ m	20	20	5
4706-1150	150x150mm	34 μ m	35 μ m	25	25	5
4706-1200	200x200mm	38 μ m	40 μ m	30	30	7



4706-1100

- Made of hardened stainless steel

135° SQUARES WITH WIDE BASE

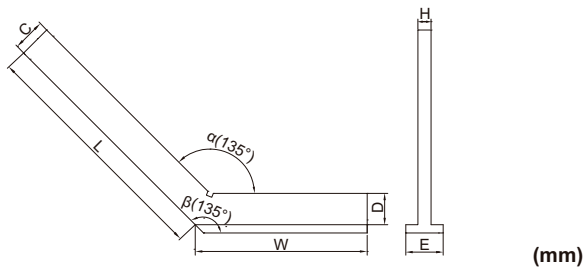

4754-3120

■ Made of hardened stainless steel

Code	Size (LxW)	Accuracy		C	D	H	E
		Inside (α)	Outside (β)				
4754-3120	120x80mm	31 μ m	33 μ m	20	20	5	20
4754-3150	150x100mm	34 μ m	36 μ m	20	20	5	20
4754-3200	200x130mm	39 μ m	41 μ m	30	30	7	30
4754-3250	250x165mm	44 μ m	46 μ m	30	30	7	30
4754-3300	300x175mm	49 μ m	51 μ m	35	35	7	35

STRAIGHT EDGES

10

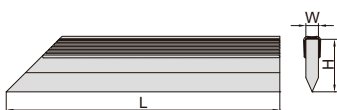

4700-100

- DIN874
- Beveled edge
- Made of hardened stainless steel
- Satin chrome plating

Code	Size (L)	Straightness	W	H
4700-50	50mm	2.2 μ m	5mm	20mm
4700-75	75mm	2.3 μ m	5mm	25mm
4700-100	100mm	2.4 μ m	5mm	25mm
4700-125	125mm	2.5 μ m	6mm	30mm
4700-150	150mm	2.6 μ m	6mm	30mm
4700-200	200mm	2.8 μ m	6mm	30mm
4700-250	250mm	3.0 μ m	8mm	40mm
4700-300	300mm	3.2 μ m	8mm	40mm
4700-400	400mm	3.6 μ m	10mm	50mm
4700-500	500mm	4.0 μ m	10mm	50mm

SQUARE SET

- Includes:
 - 90° tool maker square 25x20mm DIN875 grade 00 (code **4794-025**)
 - 90° tool maker square 40x28mm DIN875 grade 00 (code **4794-040**)
 - 90° beveled edge square 75x50mm DIN875 grade 00 (code **4790-075**)
 - straight edge 100mm DIN874 (code **4700-100**)
 - scriber
- Made of hardened stainless steel

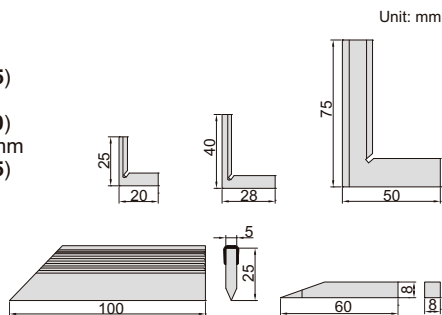

Unit: mm



4702-1

Code

4702-1

GRANITE STRAIGHT EDGES

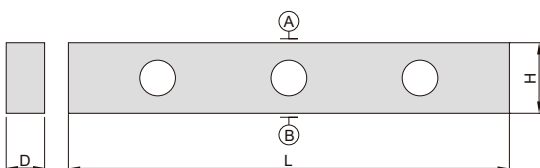

4147-500A

Code	Length (L)	Flatness of A and B	Parallelism between A and B	D	H
4147-500A	500mm	2.1 μ m	3.2 μ m	50mm	80mm
4147-1000A	1000mm	3 μ m	4.5 μ m	60mm	120mm

MAGNALIUM STRAIGHT EDGES

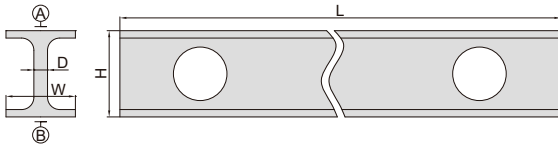

4180-1500

- Made of magnalium, light weight, non-deform, no rusty

Code	Length (L)	Flatness of A and B	Parallelism between A and B	H	W	D	Weight
4180-500	500mm	3 μ m	4 μ m	60mm	30mm	5mm	0.8kg
4180-1000	1000mm	5 μ m	8 μ m	60mm	30mm	5mm	1.5kg
4180-1500	1500mm	15 μ m	22 μ m	100mm	40mm	5mm	2.3kg
4180-2000	2000mm	18 μ m	27 μ m	100mm	40mm	8mm	6kg
4180-2500	2500mm	22 μ m	33 μ m	100mm	40mm	8mm	7.5kg
4180-3000	3000mm	48 μ m	72 μ m	100mm	40mm	8mm	9kg
4180-3500	3500mm	56 μ m	84 μ m	100mm	40mm	8mm	10kg
4180-4000	4000mm	64 μ m	110 μ m	150mm	80mm	10mm	28kg
4180-5000	5000mm	80 μ m	130 μ m	175mm	80mm	10mm	40kg
4180-6000	6000mm	100 μ m	150 μ m	175mm	80mm	10mm	50kg

10

PRECISION STRAIGHT EDGES

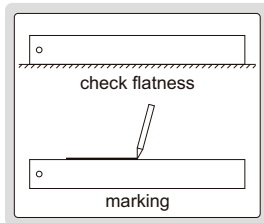

7117-300

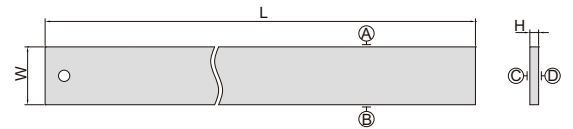

- Check flatness and for marking
- Made of tool steel

Code	Range (L)	Flatness of A and B	Flatness of C and D	W	H
7117-300	305mm	0.005mm	0.05mm	41mm	6.3mm
7117-600	610mm	0.006mm	0.06mm	51mm	7.9mm
7117-900	914mm	0.007mm	0.06mm	64mm	9.5mm

PRECISION STRAIGHT EDGES WITH BEVELED EDGE

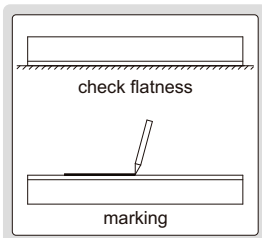

7118-300

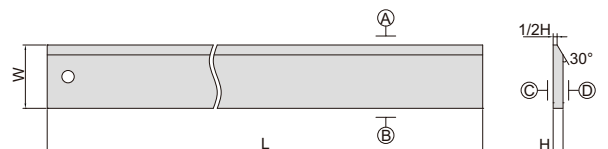

- Check flatness and for marking
- Made of tool steel

Code	Range (L)	Flatness of A and B	Flatness of C and D	W	H
7118-300	305mm	0.005mm	0.05mm	41mm	6.3mm
7118-600	610mm	0.006mm	0.06mm	51mm	7.9mm
7118-900	914mm	0.007mm	0.06mm	64mm	9.5mm

FEELER GAGE

- Made of hardened alloy steel
- Meet DIN2275
- Accuracy: $\pm(3+T/80)$ μm ,
'T' is the thickness of leaves in μm



4601-25

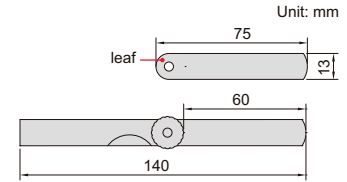

Code	Range	Thickness of leaves included (mm)	Quantity of leaves
4601-25	0.04-1.00mm	0.04, 0.05, 0.06, 0.07, 0.08, 0.09, 0.10, 0.15, 0.20, 0.25, 0.30, 0.35, 0.40, 0.45, 0.50, 0.55, 0.60, 0.65, 0.70, 0.75, 0.80, 0.85, 0.90, 0.95, 1.00	25

FEELER GAGES

11

- Made of hardened alloy steel
- Meet DIN2275
- Accuracy: $\pm(3+T/80)$ μm ,
'T' is the thickness of leaves in μm



4602-20

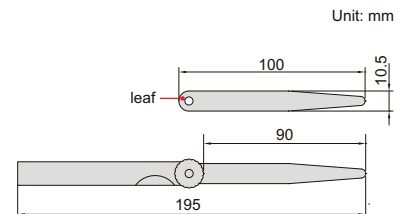

Code	Range	Thickness of leaves included (mm)	Quantity of leaves
4602-13A	0.03-0.50mm	0.03, 0.04, 0.05, 0.06, 0.07, 0.08, 0.09, 0.10, 0.15, 0.20, 0.30, 0.40, 0.50	13
4602-13	0.05-1.00mm	0.05, 0.10, 0.15, 0.20, 0.25, 0.30, 0.40, 0.50, 0.60, 0.70, 0.80, 0.90, 1.00	13
4602-17	0.02-1.00mm	0.02, 0.03, 0.04, 0.05, 0.06, 0.07, 0.08, 0.09, 0.10, 0.15, 0.20, 0.25, 0.30, 0.40, 0.50, 0.75, 1.00	17
4602-20	0.05-1.00mm	0.05, 0.10, 0.15, 0.20, 0.25, 0.30, 0.35, 0.40, 0.45, 0.50, 0.55, 0.60, 0.65, 0.70, 0.75, 0.80, 0.85, 0.90, 0.95, 1.00	20
4602-28	0.05-1.00mm	0.05, 0.06, 0.07, 0.08, 0.09, 0.10, 0.11, 0.12, 0.13, 0.14, 0.15, 0.20, 0.25, 0.30, 0.35, 0.40, 0.45, 0.50, 0.55, 0.60, 0.65, 0.70, 0.75, 0.80, 0.85, 0.90, 0.95, 1.00	28
4602-32	0.03-1.00mm	0.03, 0.04, 0.05, 0.06, 0.07, 0.08, 0.09, 0.10, 0.13, 0.15, 0.18, 0.20, 0.23, 0.25, 0.28, 0.30, 0.33, 0.35, 0.38, 0.40, 0.45, 0.50, 0.55, 0.60, 0.63, 0.65, 0.70, 0.75, 0.80, 0.85, 0.90, 1.00	32

LONG FEELER GAGES

- Made of hardened alloy steel
- Meet DIN2275
- Accuracy: $\pm(3+T/80)$ μm ,
'T' is the thickness of leaves in μm



4605-20

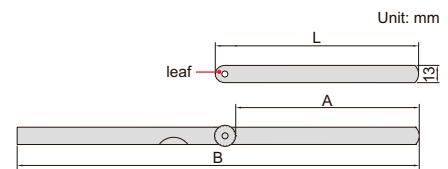

Code	Range	Thickness of leaves included (mm)	Quantity of leaves	L	A	B
4605-13	0.05-1.00mm	0.05, 0.10, 0.15, 0.20, 0.25, 0.30, 0.40, 0.50, 0.60, 0.70, 0.80, 0.90, 1.00	13	150mm	135mm	295mm
4605-131	0.05-1.00mm		13	200mm	185mm	395mm
4605-132	0.05-1.00mm		13	300mm	285mm	590mm
4605-20	0.05-1.00mm	0.05, 0.10, 0.15, 0.20, 0.25, 0.30, 0.35, 0.40, 0.45, 0.50, 0.55, 0.60, 0.65, 0.70, 0.75, 0.80, 0.85, 0.90, 0.95, 1.00	20	150mm	135mm	295mm
4605-201	0.05-1.00mm		20	200mm	185mm	395mm
4605-202	0.05-1.00mm		20	300mm	285mm	590mm

FEELER GAGE STOCKS



- Used as shims to accurately set spacing
- Made of hardened alloy steel
- Length 300mm
- Width 13mm
- 10 pcs per package



4622-10

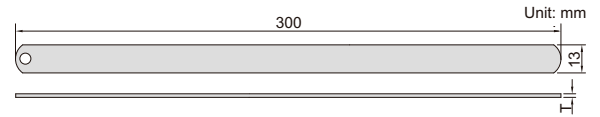

Code	Thickness (T)	Accuracy
4622-02	0.02mm	±3µm
4622-03	0.03mm	±3µm
4622-04	0.04mm	±3µm
4622-05	0.05mm	±3µm
4622-06	0.06mm	±3µm
4622-07	0.07mm	±4µm
4622-08	0.08mm	±4µm
4622-09	0.09mm	±4µm
4622-10	0.10mm	±4µm
4622-12	0.12mm	±5µm

Code	Thickness (T)	Accuracy
4622-15	0.15mm	±5µm
4622-18	0.18mm	±6µm
4622-20	0.20mm	±6µm
4622-25	0.25mm	±6µm
4622-30	0.30mm	±7µm
4622-35	0.35mm	±7µm
4622-40	0.40mm	±8µm
4622-45	0.45mm	±8µm
4622-50	0.50mm	±9µm
4622-55	0.55mm	±9µm

Code	Thickness (T)	Accuracy
4622-60	0.60mm	±9µm
4622-65	0.65mm	±9µm
4622-70	0.70mm	±12µm
4622-75	0.75mm	±12µm
4622-80	0.80mm	±13µm
4622-85	0.85mm	±13µm
4622-90	0.90mm	±14µm
4622-95	0.95mm	±14µm
4622-100	1.00mm	±16µm

FEELER GAGE TAPES

- Used as shims to accurately set spacing
- Made of hardened alloy steel
- Length 5m
- Width 13mm



4621-30

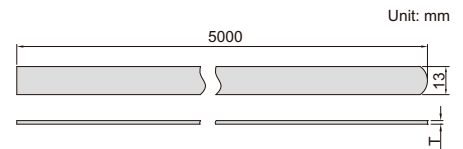

Code	Thickness (T)	Accuracy
4621-02	0.02mm	±4µm
4621-03	0.03mm	±4µm
4621-04	0.04mm	±4µm
4621-05	0.05mm	±4µm
4621-06	0.06mm	±4µm
4621-07	0.07mm	±5µm
4621-08	0.08mm	±5µm
4621-09	0.09mm	±5µm
4621-10	0.10mm	±5µm
4621-12	0.12mm	±5µm

Code	Thickness (T)	Accuracy
4621-15	0.15mm	±6µm
4621-18	0.18mm	±7µm
4621-20	0.20mm	±8µm
4621-25	0.25mm	±9µm
4621-30	0.30mm	±9µm
4621-35	0.35mm	±11µm
4621-40	0.40mm	±12µm
4621-45	0.45mm	±12µm
4621-50	0.50mm	±14µm
4621-55	0.55mm	±14µm

Code	Thickness (T)	Accuracy
4621-60	0.60mm	±14µm
4621-65	0.65mm	±14µm
4621-70	0.70mm	±17µm
4621-75	0.75mm	±17µm
4621-80	0.80mm	±19µm
4621-85	0.85mm	±19µm
4621-90	0.90mm	±22µm
4621-95	0.95mm	±22µm
4621-100	1.00mm	±24µm

GEAR TOOTH PITCH GAGES

- Check the module pitch of gear tooth
- Accuracy: ±0.05mm
- Made of hardened stainless steel

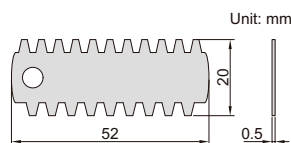

Code	Range	Pressure angle	Quantity of leaves
4860-145	0.35-4.5mm	14.5°	15
4860-245	0.35-4.5mm	20°	15
4860-112	5-12mm	14.5°	8
4860-212	5-12mm	20°	8



4860-245

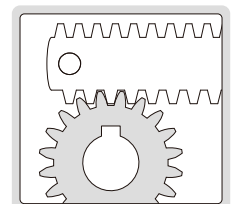

PITCH GAGES

- Check the pitch of screw thread
- Accuracy: $\pm 0.07\text{mm}$
- Made of medium carbon steel



4824-12

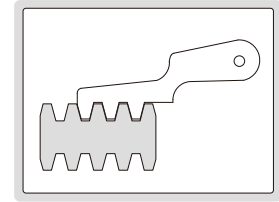

Code	Range	Thread type	Pitch of leaves included	Quantity of leaves
4824-12	2-20mm	Tr30°	2, 3, 4, 5, 6, 7, 8, 9, 10, 12, 16, 20mm	12
4824-16	1-12TPI	ACME 29°	1, 1-1/3, 1-1/2, 1-3/4, 2, 2-1/2, 3, 3-1/2, 4, 5, 6, 7, 8, 9, 10, 12TPI	16

PITCH GAGES (ECONOMIC TYPE)

ATTENTION:
LOW ACCURACY

- Check the pitch of screw thread
- Accuracy: $\pm 0.07\text{mm}$
- Made of medium carbon steel



4820-122

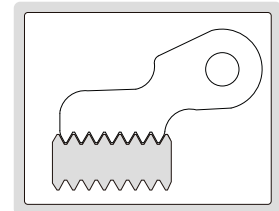

Metric 60° screw

Code	Range	Pitch of leaves included (mm)	Quantity of leaves
4820-122	0.4-7.0mm	0.4, 0.5, 0.6, 0.7, 0.75, 0.8, 0.9, 1, 1.25, 1.5, 1.75, 2, 2.5, 3, 3.5, 4, 4.5, 5, 5.5, 6, 6.5, 7	22
4820-124	0.25-7.0mm	0.25, 0.3, 0.35, 0.4, 0.5, 0.7, 0.75, 0.8, 0.9, 1, 1.25, 1.5, 1.75, 2, 2.5, 3, 3.5, 4, 4.5, 5, 5.5, 6, 6.5, 7	24
4820-1241	0.25-6.0mm	0.25, 0.3, 0.35, 0.4, 0.45, 0.5, 0.6, 0.7, 0.75, 0.8, 0.9, 1, 1.25, 1.5, 1.75, 2, 2.5, 3, 3.5, 4, 4.5, 5, 5.5, 6	24

Unified 60° screw

Code	Range	Pitch of leaves included	Quantity of leaves
4820-230	4-42TPI	4, 4-1/2, 5, 5-1/2, 6, 7, 8, 9, 10, 11, 11-1/2, 12, 13, 14, 15, 16, 18, 20, 22, 24, 26, 27, 28, 30, 32, 34, 36, 38, 40, 42TPI	30

Whitworth 55° screw

Code	Range	Pitch of leaves included	Quantity of leaves
4820-330	4-42TPI	4, 4-1/2, 5, 5-1/2, 6, 7, 8, 9, 10, 11, 12, 13, 14, 15, 16, 18, 19, 20, 22, 24, 26, 27, 28, 30, 32, 34, 36, 38, 40, 42TPI	30
4820-328	4-62TPI	4, 4-1/2, 5, 6, 7, 8, 9, 10, 11, 12, 13, 14, 16, 18, 19, 20, 22, 24, 25, 26, 28, 30, 32, 36, 40, 48, 60, 62TPI	28

Metric 60° and Whitworth 55° screw

Code	Range	Pitch of leaves included	Quantity of leaves
4820-452	0.25-6.0mm	0.25, 0.3, 0.35, 0.4, 0.45, 0.5, 0.6, 0.7, 0.75, 0.8, 0.9, 1, 1.25, 1.5, 1.75, 2, 2.5, 3, 3.5, 4, 4.5, 5, 5.5, 6mm	52
	4-62TPI	4, 4-1/2, 5, 6, 7, 8, 9, 10, 11, 12, 13, 14, 16, 18, 19, 20, 22, 24, 25, 26, 28, 30, 32, 36, 40, 48, 60, 62TPI	
4820-450	0.4-7.0mm	0.4, 0.5, 0.6, 0.7, 0.75, 0.8, 0.9, 1, 1.25, 1.5, 1.75, 2, 2.5, 3, 3.5, 4, 4.5, 5, 5.5, 6, 6.5, 7mm	50
	4-62TPI	4, 4-1/2, 5, 6, 7, 8, 9, 10, 11, 12, 13, 14, 16, 18, 19, 20, 22, 24, 25, 26, 28, 30, 32, 36, 40, 48, 60, 62TPI	

Metric 60° and Unified 60° screw

Code	Range	Pitch of leaves included	Quantity of leaves
4820-552	0.4-7.0mm	0.4, 0.5, 0.6, 0.7, 0.75, 0.8, 0.9, 1, 1.25, 1.5, 1.75, 2, 2.5, 3, 3.5, 4, 4.5, 5, 5.5, 6, 6.5, 7mm	52
	4-42TPI	4, 4-1/2, 5, 5-1/2, 6, 7, 8, 9, 10, 11, 11-1/2, 12, 13, 14, 15, 16, 18, 20, 22, 24, 26, 27, 28, 30, 32, 34, 36, 38, 40, 42TPI	

CENTER GAGES

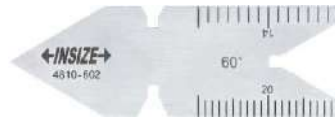
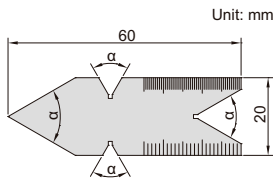

4810-602

- To check and set screw cutting tools, and check the angle and pitch of screw thread
- Angle accuracy: $\pm 30\text{min}$.
- Made of stainless steel

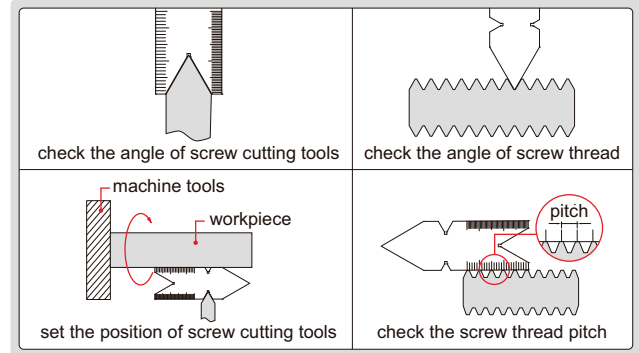

Code	Thread type	Angle (α)	Graduation
4810-601	METRIC 60°	60°	0.5mm and 1mm
4810-602	UNIFIED 60°	60°	14ths and 20ths on front side, 24ths and 32ths on back side
4810-55	WHITWORTH 55°	55°	14ths and 20ths on front side, 24ths and 32ths on back side

THREAD GAGES



4812-E

- To check and set screw cutting tools
- Angle accuracy: $\pm 10\text{min}$.
- Made of medium carbon steel

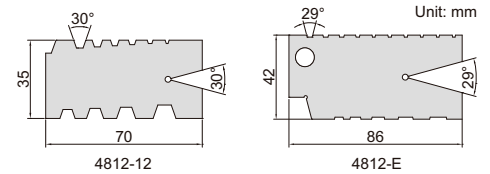

Code	Range	Thread type	Pitch
4812-12	2-12mm	Tr 30°	2, 3, 4, 5, 6, 7, 8, 9, 10, 12mm
4812-E	1-10TPI	ACME 29°	1, 1-1/3, 1-1/2, 1-3/4, 2, 2-1/2, 3, 4, 5, 6, 7, 8, 9, 10TPI

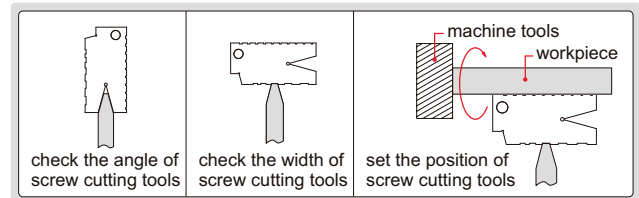

ANGLE GAGE SET

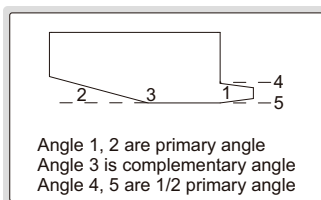

type A

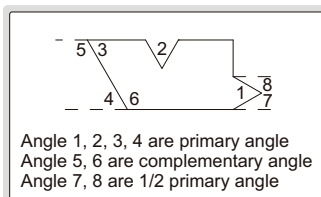

type B



4807

- Each blade checks primary, 1/2 primary and complementary angles
- Made of medium carbon steel

Code	Quantity of leaves	Accuracy
4807	18	$\pm 10'$

Primary angle	1/2 primary angle	Complementary angle	Type
5°	2°30'	175°	A
10°	5°	170°	A
15°	7°30'	165°	A
20°	10°	160°	B
25°	12°30'	155°	B
30°	15°	150°	B
35°	17°30'	145°	B
40°	20°	140°	B
45°	22°30'	135°	B
50°	25°	130°	B
55°	27°30'	125°	B
60°	30°	120°	B
65°	32°30'	115°	B
70°	35°	110°	B
75°	37°30'	105°	B
80°	40°	100°	B
85°	42°30'	95°	B
90°	45°	90°	B

ANGLE GAGE

- To check complementary angles
- Made of stainless steel



4806-20

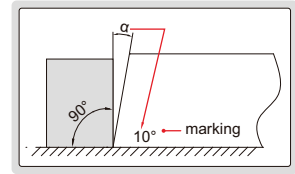

Code	Range (α)	Angle of leaves included	Quantity of leaves	Accuracy
4806-20	1°-45°	1°, 2°, 3°, 4°, 5°, 6°, 7°, 8°, 9°, 10°, 12°, 14°, 16°, 18°, 20°, 25°, 30°, 35°, 40°, 45°	20	±30'

RADIUS GAGES (ECONOMIC TYPE)

ATTENTION:
LOW ACCURACY

- Made of medium carbon steel



4801-17

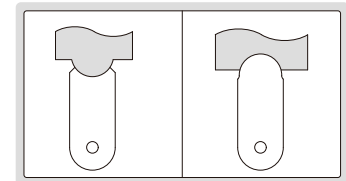

Code	Range	Radius of leaves included (mm)	Quantity of leaves (internal + external)	Accuracy
4801-17	1-7mm	1, 1.25, 1.5, 1.75, 2, 2.25, 2.5, 2.75, 3, 3.5, 4, 4.5, 5, 5.5, 6, 6.5, 7	17+17	±0.030mm
4801-16	7.5-15mm	7.5, 8, 8.5, 9, 9.5, 10, 10.5, 11, 11.5, 12, 12.5, 13, 13.5, 14, 14.5, 15	16+16	±0.035mm
4801-15	15.5-25mm	15.5, 16, 16.5, 17, 17.5, 18, 18.5, 19, 19.5, 20, 21, 22, 23, 24, 25	15+15	±0.042mm

11

RADIUS GAGE

- Made of stainless steel

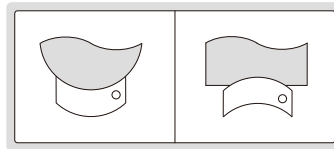

4802-31

Code	Range	Radius of leaves included (mm)	Quantity of leaves	Accuracy
4802-31	25-40mm	25, 25.5, 26, 26.5, 27, 27.5, 28, 28.5, 29, 29.5, 30, 30.5, 31, 31.5, 32, 32.5, 33, 33.5, 34, 34.5, 35, 35.5, 36, 36.5, 37, 37.5, 38, 38.5, 39, 39.5, 40	31 pcs	±0.06mm

RADIUS GAGE SET (ECONOMIC TYPE)

ATTENTION:
LOW ACCURACY

- Each piece has 3 concave and 2 convex gauging surfaces
- Supplied with handle
- Made of medium carbon steel

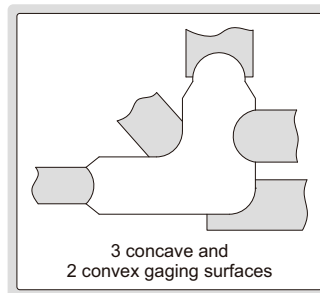

4804-26

Code	Range	Radius of leaves included (mm)	Quantity of leaves	Accuracy
4804-26	0.5-13mm	0.5, 1, 1.5, 2, 2.5, 3, 3.5, 4, 4.5, 5, 5.5, 6, 6.5, 7, 7.5, 8, 8.5, 9, 9.5, 10, 10.5, 11, 11.5, 12, 12.5, 13	26	±0.05mm

CHAMFER GAGE

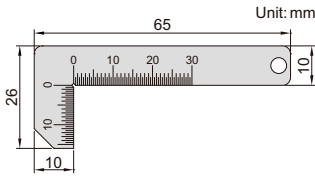

- To measure internal and external chamfers
- Made of stainless steel

Code	Graduation	Accuracy
4844-1	0.5mm	±0.25mm



4844-1

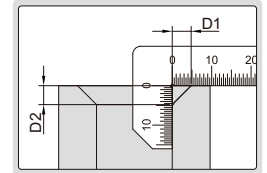
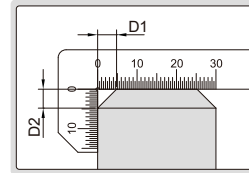

DATA OUTPUT

DIGITAL CHAMFER GAGES

- Measure 30°/45°/60° chamfer dimension
- Resolution: 0.01mm/0.0005"
- Buttons: on/off, zero, mm/inch
- Automatic power off, move the digital unit to turn on power
- Battery CR2032
- Data output
- Made of stainless steel
- Optional accessory: data output cable (code 7315-, 7302-, 7305-, for chamfer gages without built-in wireless)



1180-6

preset buttons

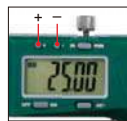

measure chamfer dimension

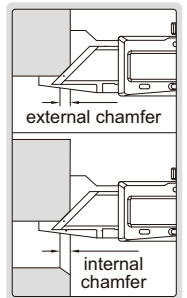

11

Code	Range	Accuracy	Chamfer (α)	Wireless
1180-6	0-10mm/0-0.39"	±0.06mm	45°	no
1180-6WL				built-in wireless
1180-63	0-10mm/0-0.39"	±0.06mm	30°	no
1180-63WL				built-in wireless
1180-66	0-10mm/0-0.39"	±0.06mm	60°	no
1180-66WL				built-in wireless

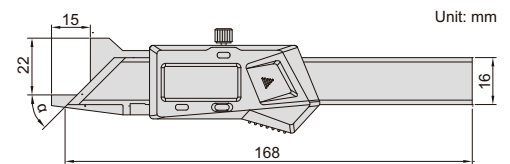

Unit: mm

CHAMFER GAGES

- Measure 30°/45°/60° chamfer dimension
- Graduation 0.02mm
- Made of stainless steel
- Satin chrome plated reading surface



1267-6

measure chamfer dimension

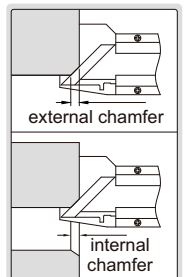

Code	Range	Accuracy	Chamfer (α)
1267-6	0-10mm	±0.06mm	45°
1267-63	0-10mm	±0.06mm	30°
1267-66	0-10mm	±0.06mm	60°

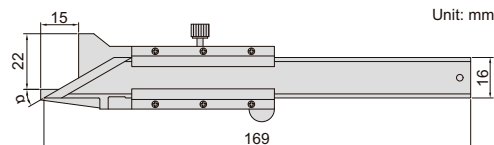

Unit: mm

CHAMFER HEIGHT GAGE

INSIZE PLUS
MADE IN GERMANY

setting gage (included)



- Measure outside or inside chamfer height
- Suitable for diameter of bores $\geq 6\text{mm}$, chamfer angle $\alpha \geq 30^\circ$
- Setting gage is included

Code	Range (L)	Graduation	Accuracy
2943-1	0.2-5mm	0.01mm	$\pm 0.02\text{mm}$



2943-1

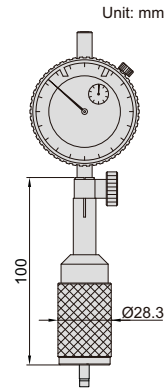

Unit: mm

principle of measurement

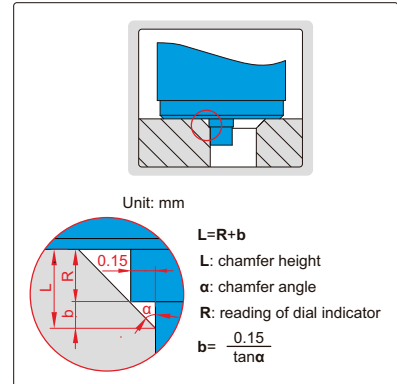

DIGITAL CHAMFER HEIGHT GAGE

INSIZE PLUS
MADE IN GERMANY

setting gage (included)



- Measure outside or inside chamfer height
- Suitable for diameter of bores $\geq 6\text{mm}$, chamfer angle $\alpha \geq 30^\circ$
- Resolution: 0.01mm/0.0005"
- Setting gage is included
- Optional accessory: data output cable (code 7315-, 7302-, 7305-)

Code	Range (L)	Accuracy
2944-1	0.2-5mm/0.008-0.197"	$\pm 0.02\text{mm}$



2944-1

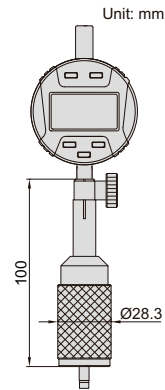

Unit: mm

principle of measurement

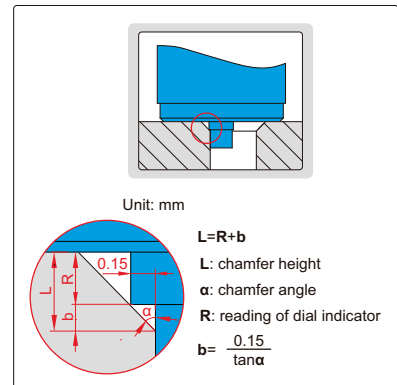

DIGITAL TAPER SLOT GAGES

- Measuring opening, slot width
- Resolution: 0.01mm/0.0005"
- Buttons: on/off, zero, mm/inch
- Automatic power off, move the digital unit to turn on power
- Battery CR2032, data output
- Made of stainless steel
- Optional accessory: data output cable (code 7315-, 7302-, 7305-, for taper slot gages without built-in wireless)

Code	Range	Accuracy	L	Wireless
1160-10	0.2-10mm/0.01-0.39"	$\pm 0.03\text{mm}$	—	no
1160-10WL				built-in wireless
1160-20	10-20mm/0.39-0.79"	$\pm 0.05\text{mm}$	10mm	no
1160-20WL				built-in wireless
1160-30	20-30mm/0.79-1.18"	$\pm 0.05\text{mm}$	20mm	no
1160-30WL				built-in wireless
1160-40	30-40mm/1.18-1.58"	$\pm 0.05\text{mm}$	30mm	no
1160-40WL				built-in wireless

DATA OUTPUT

ATTENTION: ACTUAL SLOT WIDTH IS 1/10 OF THE READING



1160-10

measure slot width

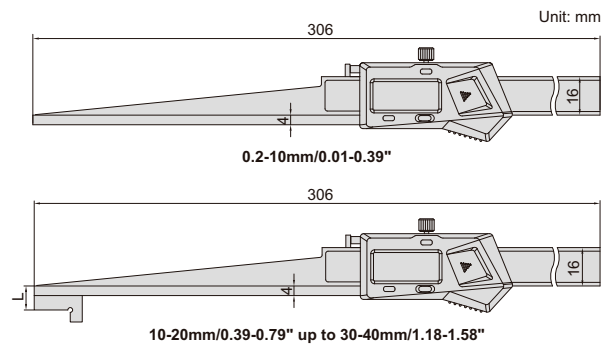
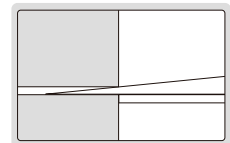

TAPER SLOT GAGES

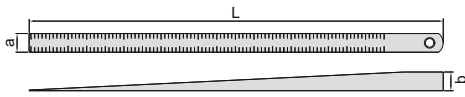

- For quick measurement of slot width
- Satin chrome plated reading surface
- Made of stainless steel



4630-1

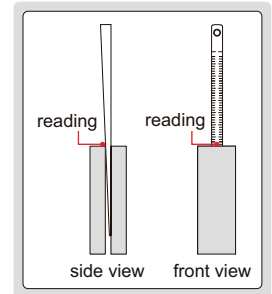

Code	Range	Graduation	Accuracy	L	a	b
4630-3	0.4-6mm	0.05mm	±0.04mm	164mm	12.5mm	6.5mm
4630-1	0.5-10mm	0.05mm	±0.07mm	220mm	10mm	10.5mm
4630-2	0.5-15mm	0.1mm	±0.08mm	184mm	12.5mm	16.5mm

TAPER GAGES

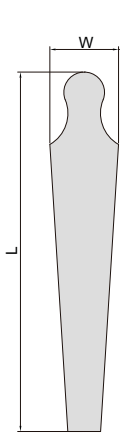

front



back

4833-2

- Measure opening, slot width, hole diameter, etc.
- Diameter correction table on the back (only for 4833-1, 4833-2)
- Made of stainless steel

measure diameter of hole

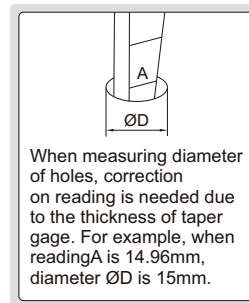

measure slot width

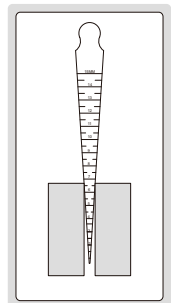

Code	Range	Graduation	Accuracy	L	W
4833-1	0.8-15mm	0.1mm	±0.1mm	146	17
4833-2	15-30mm	0.1mm	±0.1mm	159	30.4
4833-3	30-45mm	0.1mm	±0.1mm	166	45.4
4833-4	45-60mm	0.1mm	±0.1mm	170	60.5

TAPER GAGE SET



front

back

4837-1

- Include 4 pcs (1-8mm, 8-15mm, 15-22mm, 22-29mm)
- Measure opening, slot width, hole diameter, etc.
- Diameter correction table on the back
- Made of stainless steel

Code	Range	Graduation	Accuracy
4837-1	1-29mm	0.05mm	±0.05mm

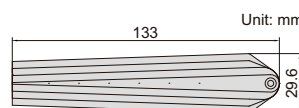

measure diameter of hole

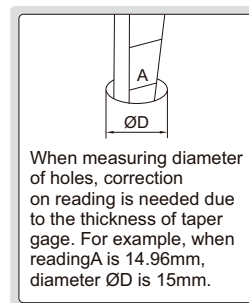

measure slot width

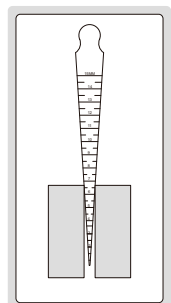

TAPER BORE GAGES

- Quick measurement of bore diameter
- Hardened steel, HRC50-58
- Satin chrome plated surface
- Aluminium oxidized handle

(mm)						
Code	Range	Graduation	Accuracy	L	Ød1	Ød2
4852-1	1-6.5mm	0.1mm	±0.05mm	62.5	7	0.8
4852-3	3-16mm	0.1mm	±0.05mm	143	17	2.8
4852-15	15-30mm	0.1mm	±0.05mm	165	31	14.7
4852-30	30-45mm	0.1mm	±0.05mm	165	46	29.6



4852-15

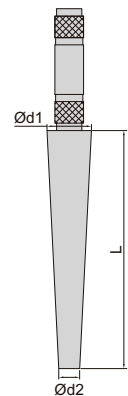

WELDING GAGE

11

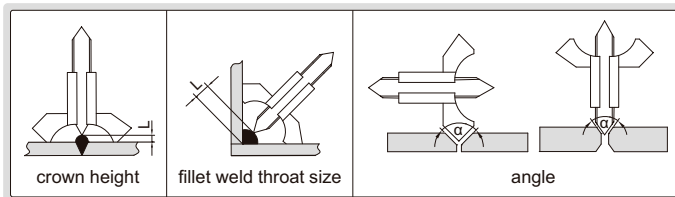

4830

- Made of stainless steel
- Satin chrome plated reading surface

Code	Measurement	Range	Graduation	Accuracy
4830	crown height	0-8mm	0.1mm	±0.1mm
	fillet weld throat size	0-20mm	0.1mm	±0.3mm
	angle	60°, 70°, 80°, 90°	—	±1°

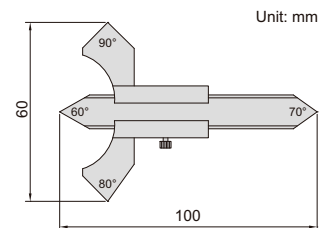

DIGITAL WELDING GAGE

ATTENTION:
NO DATA OUTPUT

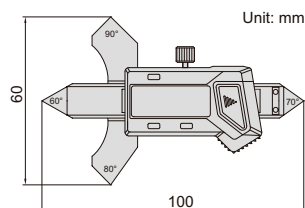

4831-20A

- Buttons: zero, mm/inch, on/off
- Battery LR44
- Made of stainless steel

Code	Measurement	Range	Resolution	Accuracy
4831-20A	crown height	0-7mm	0.01mm/0.0005"	±0.03mm
	fillet weld throat size	0-20mm	0.01mm/0.0005"	±0.1mm
	angle	60°, 70°, 80°, 90°	—	±1°

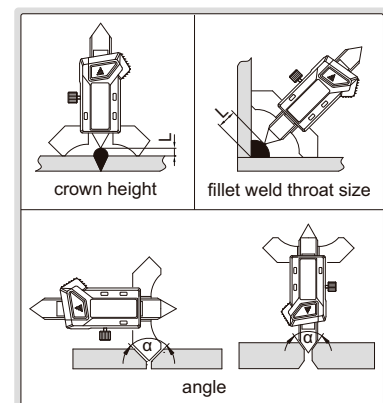

FILLET WELDING GAGES

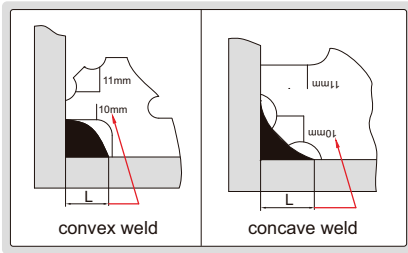

4836-1



4836-2

- Measure concave and convex weld sizes
- 7 blades are included
- Made of stainless steel

Code	Size	Accuracy
4836-1	3mm, 4mm, 5mm, 6mm, 8mm, 9mm, 10mm, 11mm, 12mm, 14mm, 16mm, 19mm, 22mm, 25mm	±0.5mm
4836-2	1/8" (3.2mm), 3/16" (4.8mm), 1/4" (6.4mm), 5/16" (7.9mm), 3/8" (9.5mm), 7/16" (11.1mm), 1/2" (12.7mm), 5/8" (15.9mm), 3/4" (19.1mm), 7/8" (22.2mm), 1" (25.4mm)	±0.02" (0.5mm)

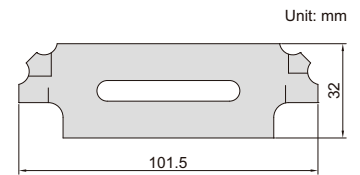

11

FILLET WELDING GAGE

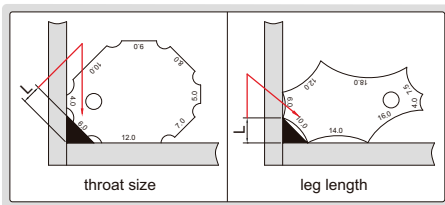

4832-1

- Made of stainless steel
- Sizes marked on both faces

Code	Throat size	Leg length	Accuracy
4832-1	4, 5, 6, 7, 8, 9, 10, 12mm	4, 6, 7.5, 10, 12, 14, 16, 18mm	±0.5mm

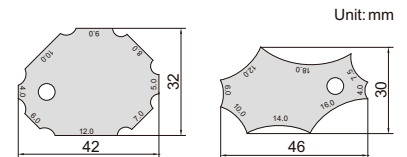

WELDING GAGE

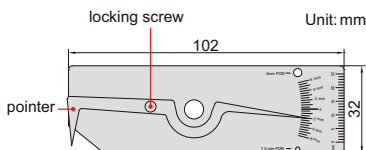

4834-1

- Pointer can be locked for later reference
- Made of stainless steel

Code	Measurement	Range	Graduation	Accuracy
4834-1	undercut depth	0-6mm	0.5mm	±0.5mm
	crown height	0-6mm	0.5mm	±0.5mm
	porosity size comparison	1.5mm, 3mm	—	±0.2mm
	amount of porosity per 25mm	25mm	1mm	—

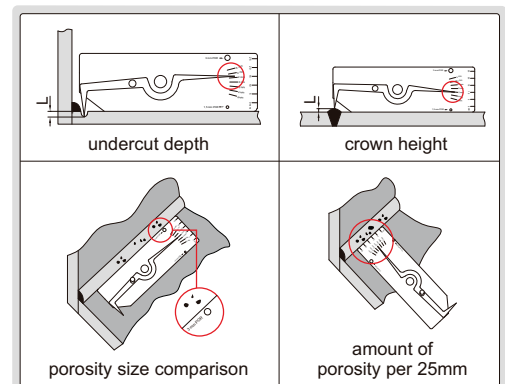

WELDING GAGE

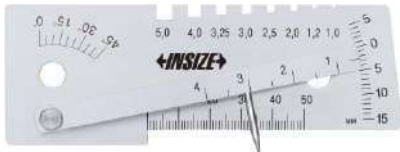

4848-1

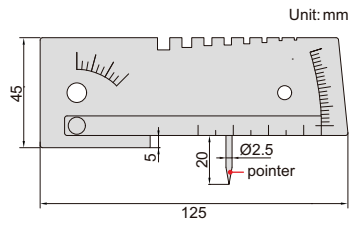

Unit: mm

- Made of stainless steel

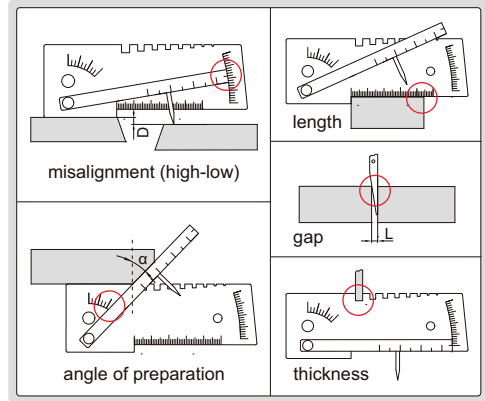

Code	Measurement	Range	Graduation	Accuracy
4848-1	misalignment (high-low)	-5mm~+15mm	1mm	±0.5mm
	angle of preparation	0°-45°	5°	±2.5°
	length	0-50mm	1mm	±0.5mm
	gap	1-4mm	0.5mm	±0.25mm
	thickness	1, 1.2, 2.0, 2.5, 3.0, 3.25, 4.0, 5.0mm	—	±0.1mm

FILLET WELDING GAGE

11

- Measure convex weld sizes
- 3 blades are included
- Made of stainless steel

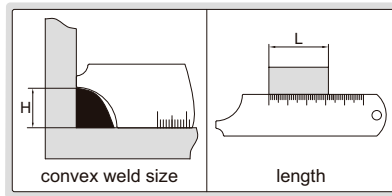

4847-1

Code	Measurement	Range	Graduation	Accuracy
4847-1	convex weld size	4, 6, 8, 10, 12, 14mm	—	±0.5mm
	length	0 - 50mm	1mm	±0.5mm

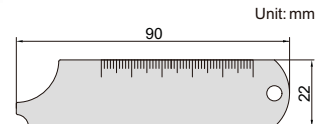

Unit: mm

WELDING GAGE

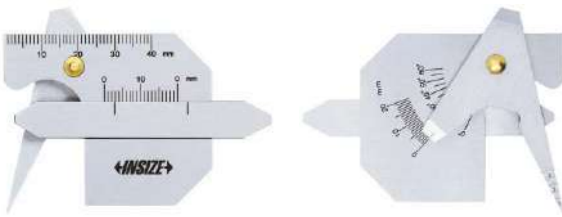

front

6832-1

back

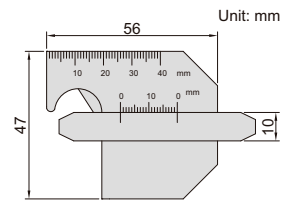

Unit: mm

- Made of stainless steel
- Satin chrome plated surface

Code	Measurement	Range	Graduation	Accuracy
6832-1	leg length	0-20mm	1mm	±0.3mm
	leg height	0-20mm	1mm	±0.3mm
	crown height	0-20mm	1mm	±0.3mm
	throat size	0-10mm	1mm	±0.3mm
	angle	0°-60°	5°	±1°
	gap	1-3.5mm	0.5mm	±0.2mm
	length	0-40mm	1mm	±0.3mm

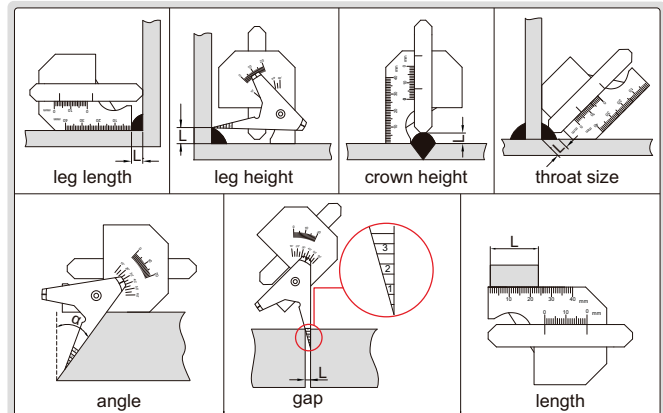

WELDING GAGE

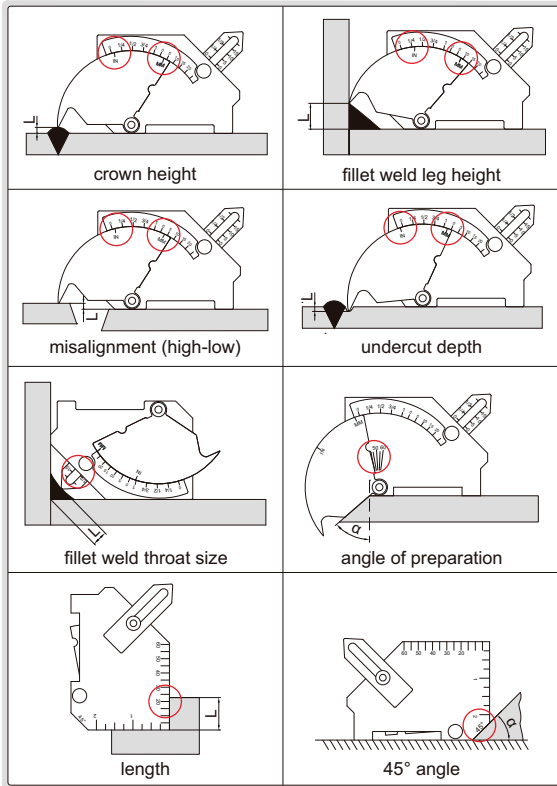

front

4835-1

back

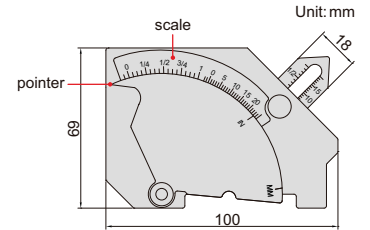

- Adjustable scale to compensate pointer wear
- Made of stainless steel

Code	Measurement	Range	Graduation	Accuracy
4835-1	crown height	0-25mm (0-1")	1mm (1/16")	±0.5mm
	fillet weld leg height	0-25mm (0-1")	1mm (1/16")	±0.5mm
	misalignment (high-low)	0-25mm (0-1")	1mm (1/16")	±0.5mm
	undercut depth	0-2mm (0-1/8")	1mm (1/16")	±0.5mm
	fillet weld throat size	0-20mm (0-3/4")	1mm (1/16")	±0.5mm
	angle of preparation	0-60°	5°	±1°
	length	0-60mm (0-2")	1mm (1/16")	±0.5mm
	45° angle	—	—	±1°

11

WELDING GAGES

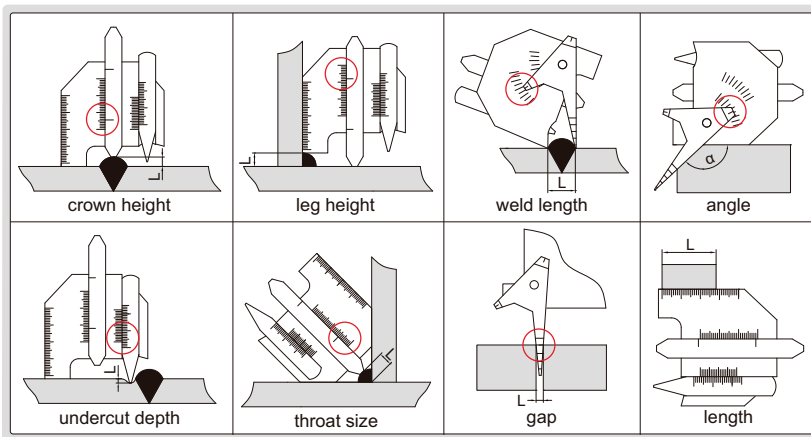

front

4838-1

back

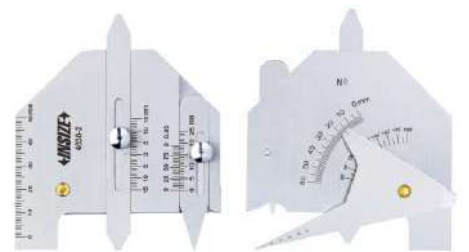

front

4838-2

back

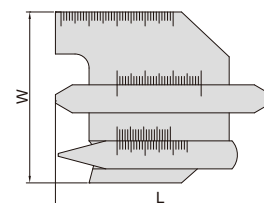

- Made of stainless steel

Measurement	Range	Code 4838-1		Code 4838-2		
		Graduation	Accuracy	Range	Graduation	Accuracy
crown height	0-10mm	1mm	±0.5mm	0-15mm	1mm	±0.5mm
leg height	0-14mm	1mm	±0.5mm	0-15mm	1mm	±0.5mm
undercut depth	0-5mm	0.05mm	±0.05mm	0-5mm	0.05mm	±0.05mm
throat size	0-13mm	1mm	±0.5mm	0-13mm	1mm	±0.5mm
weld length	0-40mm	1mm	±1mm	0-60mm	1mm	±1mm
angle	90°-150°	5°	±1°	80°-160°	5°	±1°
gap	0.5-5mm	1mm	±0.5mm	1-6mm	1mm	±0.5mm
length	0-40mm	1mm	±0.5mm	0-50mm	1mm	±0.5mm
LxW		62x77mm		99x84mm		

WELDING UNDERCUT GAGE

application

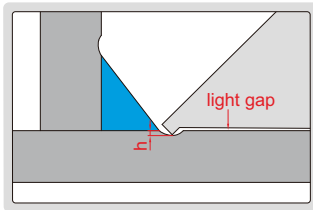

when there is a light gap, $h < 0.25\text{mm}$;
when there is no light gap, $h \geq 0.25\text{mm}$

- Measure undercut
- Calibration block is included
- Made of stainless steel



4849-1

calibration block (included)



Code
4849-1

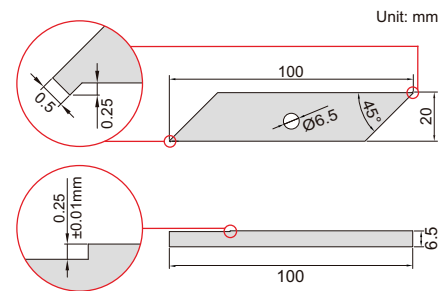

WELDING GAGE

11

- Made of stainless steel

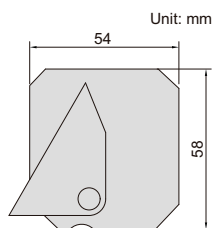

4850-1

Code	Measurement	Range	Graduation	Accuracy
4850-1	leg height (b)	0-18mm	1mm	$\pm 0.5\text{mm}$
	theoretical throat size (a)	2-12mm	1mm	$\pm 0.5\text{mm}$
	throat size	4, 5, 6, 7mm	—	$\pm 0.5\text{mm}$
	angle of preparation	50°, 60°	—	$\pm 1^\circ$
	thickness	1.5, 2, 3.5mm	—	$\pm 0.2\text{mm}$

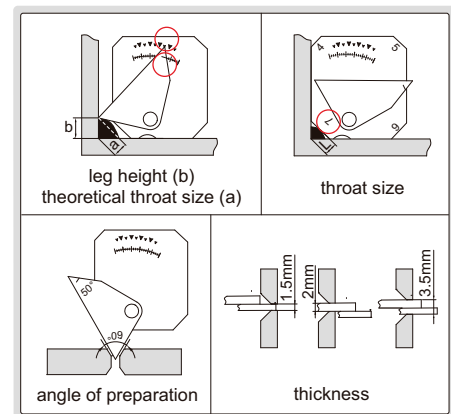

FILLET WELDING GAGE

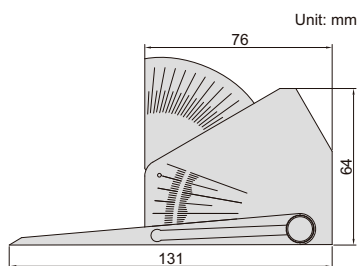

4846-1

- Calculating card is included
- Made of stainless steel

Code	Measurement	Range	Graduation	Accuracy
4846-1	weld seam height W	0-50mm/0-2"	2mm/.050"	$\pm 1\text{mm}$
	angle θ	30°-90°	2.5°	$\pm 1^\circ$
	60° angle	—	—	$\pm 0.5^\circ$

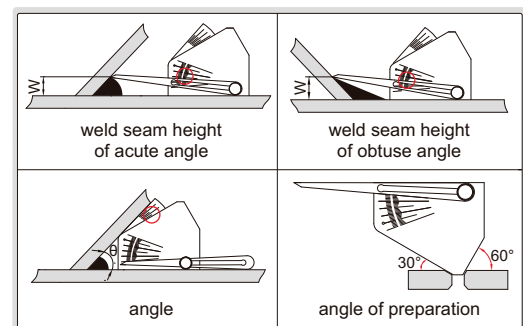

calculating card (included)

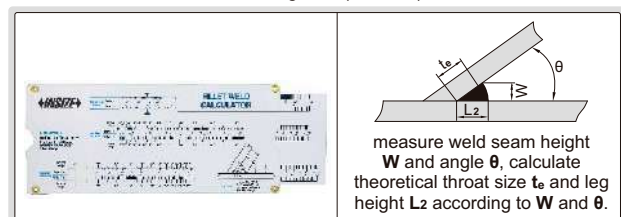

WELDING GAGE

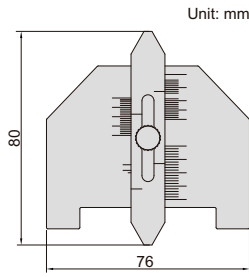
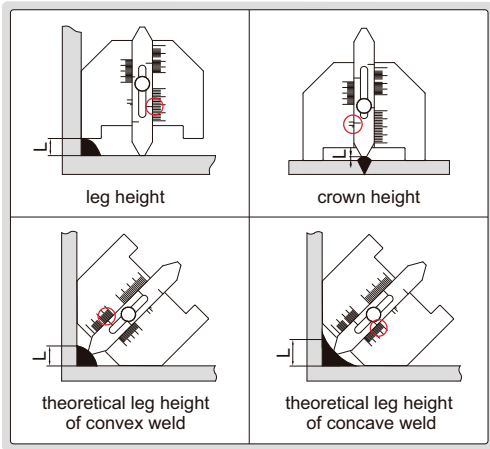

4851-1

Code	Measurement	Range	Graduation	Accuracy
4851-1	leg height	0-20mm	1mm	±0.5mm
	crown height	0-3mm	—	±0.5mm
	theoretical leg height of convex weld	0-20mm	1mm	±0.5mm
	theoretical leg height of concave weld	0-20mm	1mm	±0.5mm

■ Made of stainless steel

WELDING GAGE

■ Made of stainless steel

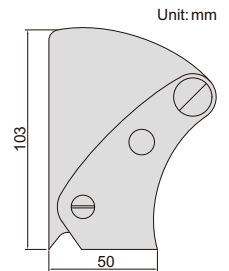
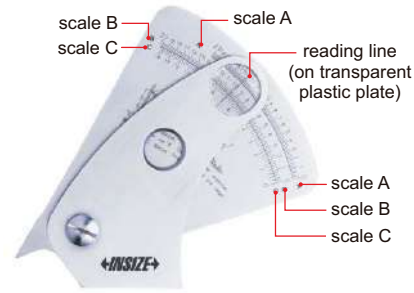
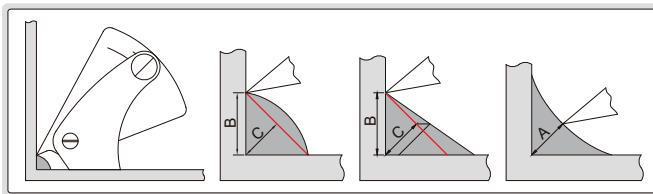

4840-1

Code	Graduation	Accuracy
4840-1	0.2mm	±0.3mm

PIPE WELDING GAGE

■ Made of stainless steel

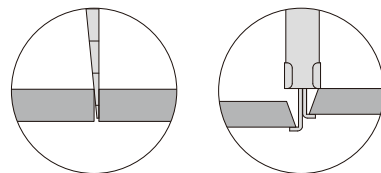

fit-up gap

internal misalignment



4841-1

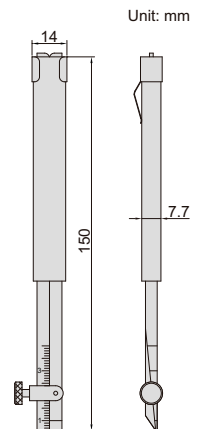

Code	Measurement	Range	Graduation	Accuracy
4841-1	internal misalignment	0-30mm	1mm	±0.5mm
	fit-up gap	0.7-4mm	0.1mm	±0.1mm

PIPE WELDING GAGE

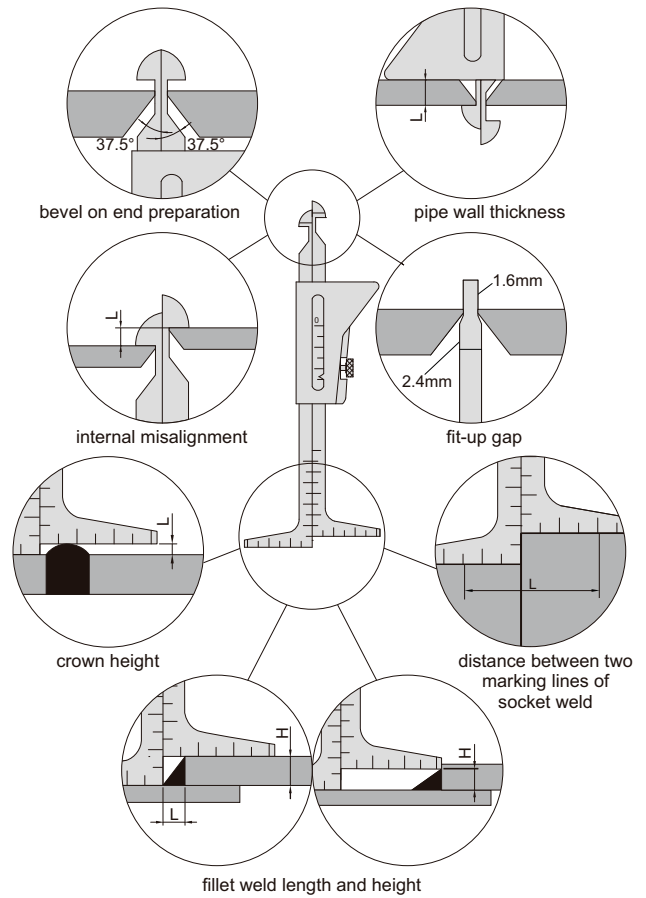
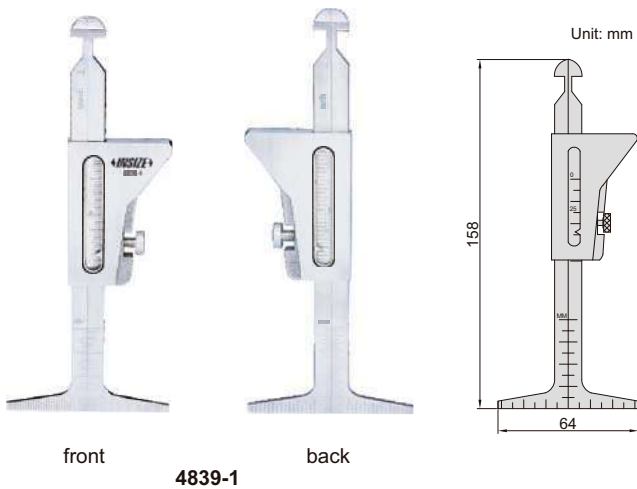

- Made of stainless steel

Code	Measurement	Range	Graduation	Accuracy
4839-1	bevel on end preparation	37.5°	—	±1°
	pipe wall thickness	0-45mm (0~1-3/4")	1mm (1/16")	±0.5mm
	internal misalignment	0-35mm (0~1-3/8")	1mm (1/32")	±0.5mm
	fit-up gap	1.6mm, 2.4mm	—	±0.1mm
	crown height	0-35mm (0~1-3/8")	1mm (1/32")	±0.5mm
	distance between two marking lines of socket weld	0-60mm (0~2-3/8")	1mm (1/16")	±0.5mm
	fillet weld length	0-30mm (0~1-1/4")	1mm (1/16")	±0.5mm
	fillet weld height	0-35mm (0~1-3/8")	1mm (1/32")	±0.5mm

6-PIECE WELDING GAGE SET

- Includes:
 - 1) Welding gage (code **4834-1**)
 - 2) Fillet welding gage, size 3~25mm, 7 blades (code **4836-1**)
 - 3) Pipe welding gage (code **4841-1**)
 - 4) Telescoping inspection mirror, size of mirror Ø32mm, length 178~505mm (code **7160-1**)
 - 5) Pocket rule with sliding clip, range 150mm/6", graduation 1mm, 1/64" (code **7119-150**)
 - 6) LED flashlight (code **ISGF-0501**)



Code
5064

5064

7-PIECE WELDING GAGE SET

- Includes:
 - 1) Welding gage (code **4834-1**)
 - 2) Welding gage (code **4851-1**)
 - 3) Pipe welding gage (code **4839-1**)
 - 4) Outside micrometer, range 0-25mm, graduation 0.01mm (code **3203-25A**)
 - 5) Telescoping inspection mirror, size of mirror Ø32mm, length 178~505mm (code **7160-1**)
 - 6) Magnifier with illumination, magnification 4X (code **7513-4**)
 - 7) Steel rule, range 150mm/6", graduation 0.5mm, 1mm, 1/64", 1/32", 1/16" (code **7110-150**)

Code
5071



5071

7-PIECE WELDING GAGE SET

- Includes:
 - 1) Welding gage (code **4834-1**)
 - 2) Welding gage (code **4851-1**)
 - 3) Fillet welding gage, size 3~25mm, 7 blades (code **4836-1**)
 - 4) Outside micrometer, range 0-25mm, graduation 0.01mm (code **3203-25A**)
 - 5) Digital caliper, range 0-150mm/0-6", resolution 0.01mm/0.005" (code **1108-150**)
 - 6) Pocket rule with sliding clip, range 150mm/6", graduation 1mm, 1/64" (code **7119-150**)
 - 7) Magnifier with illumination, magnification 4X (code **7513-4**)

Code
5072



5072

11

- For twist drills with 118° angle, to check if the center of tip is concentric with the drill body
- Made of stainless steel

Code	Accuracy	
	Angle	Length
4843-1	±0.5°	±0.5mm



4843-1

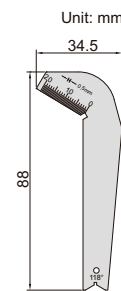

DRILL POINT GAGE

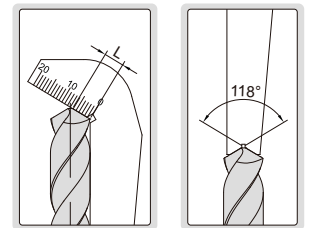

- Check drills with angle 60°, 70°, 90°, 118°, 125°, 135°, 150° or 160°
- Made of stainless steel

Code	Accuracy
4842-1	±0.5°



4842-1

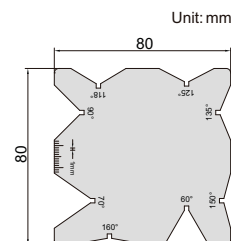

DRILL ANGLE GAGE

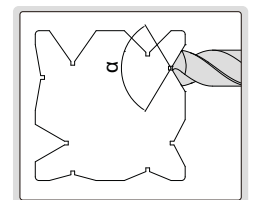

INSIDE CALIPERS

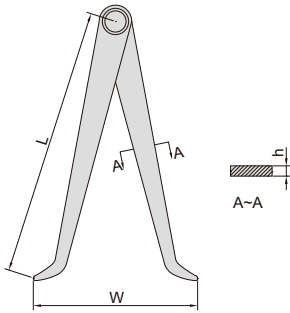

7240-150

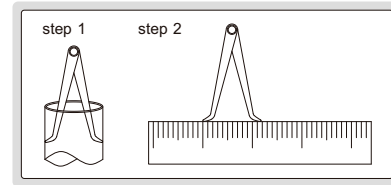

■ Made of carbon steel

Code	Size (L)	Range (W)	h
7240-150	150mm	17-150mm	2mm
7240-200	200mm	17-200mm	3mm
7240-300	300mm	18-300mm	3mm

OUTSIDE CALIPERS

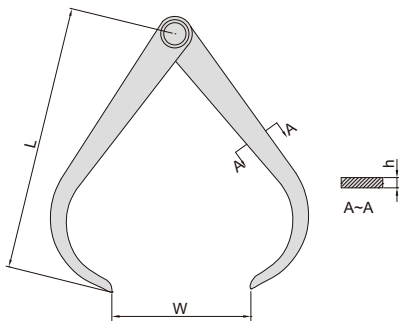

7241-150

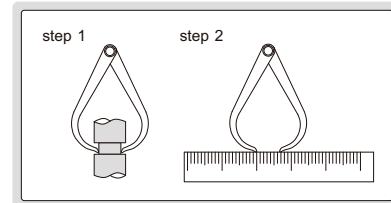

■ Made of carbon steel

Code	Size (L)	Range (W)	h
7241-150	150mm	0-150mm	2mm
7241-200	200mm	0-200mm	3mm
7241-300	300mm	0-300mm	3mm

11

INSIDE SPRING CALIPERS



■ Made of carbon steel

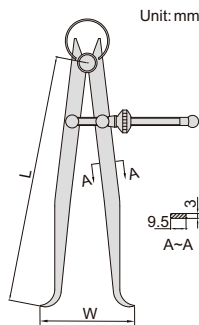

7261-150

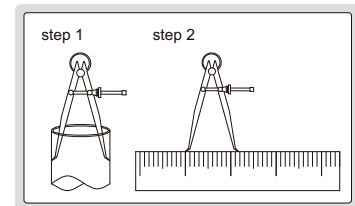

Code	Size (L)	Range (W)
7261-150	150mm	20-170mm
7261-200	200mm	22-220mm
7261-250	245mm	30-270mm
7261-300	300mm	30-320mm

OUTSIDE SPRING CALIPERS



■ Made of carbon steel

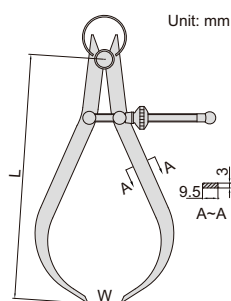

7262-150

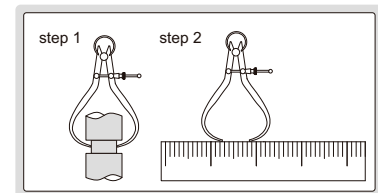

Code	Size (L)	Range (W)
7262-150	155mm	0-140mm
7262-200	210mm	0-210mm
7262-250	265mm	0-270mm
7262-300	310mm	0-320mm

SPRING DIVIDERS

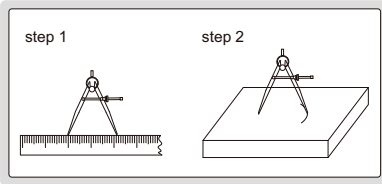

Code	Size (L)	Range (W)
7260-150	150mm	0-150mm
7260-200	200mm	0-210mm
7260-250	245mm	0-260mm
7260-300	300mm	0-320mm

- Made of carbon steel
- Hardened points



7260-150

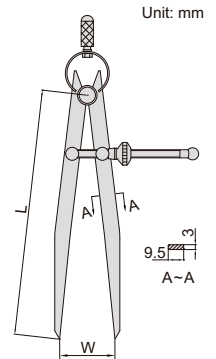

Unit: mm

DIVIDERS

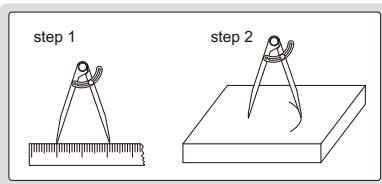

Code	Size (L)	Range (W)	(mm)	
			a	b
7247-150	150mm	0-140mm	8.5	7
7247-200	200mm	0-190mm	10	7
7247-300	300mm	0-290mm	12	7

- Made of carbon steel
- Hardened points



7247-150

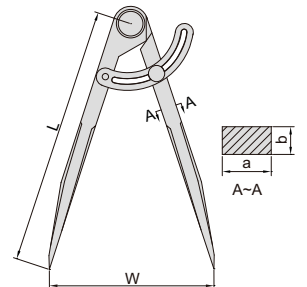

MEASURING TAPES

EG II

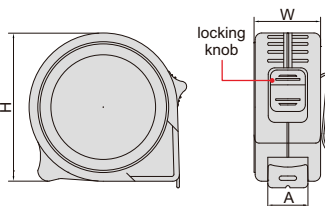

- Non-glare nylon surface for wear resistance

Code	Range	Graduation	Width of tape A	W	H
7140-3	0-3m	1mm	16mm	28mm	62mm
7140-5	0-5m	1mm	19mm	30mm	68mm
7140-8	0-8m	1mm	25mm	38mm	78mm



7140-5



graduation



packaging

MEASURING TAPE (BASIC TYPE)

EG II

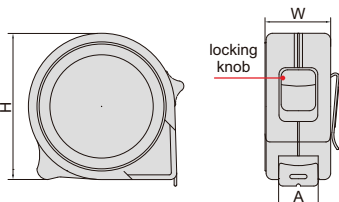

- Non-glare nylon coating tape, wear resistance

Code	Range	Graduation	Width of tape A	W	H
7142-5	0-5m/0-16ft	1mm, 1/16"	19mm	31mm	64mm



7142-5



graduation



packaging

LONG MEASURING TAPE

EG II

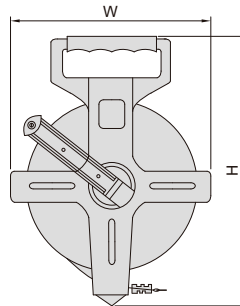
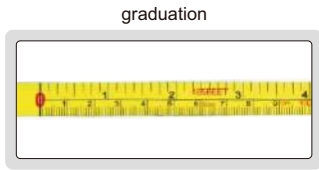

- High tensile strength fibreglass tape
- Nylon coating tape, wear resistance

Code	Range	Graduation	Width of tape	W	H
7143-50	0-50m/0-165ft	1mm, 1/8"	13mm	220mm	320mm

7143-50

MEASURING WHEEL (BASIC TYPE)

11

- ABS plastic frame, wear-resistant PU tire
- Three-section adjustable handle

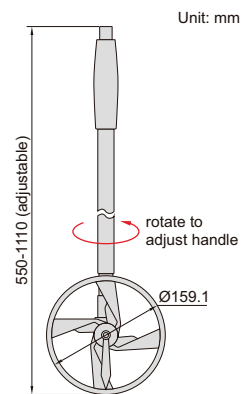

Code	Range	Resolution
7144-1	0.1-9999.9m	0.1m

7144-1

MEASURING WHEEL

- ABS plastic frame, wear-resistant PU tire
- Two-section foldable handle

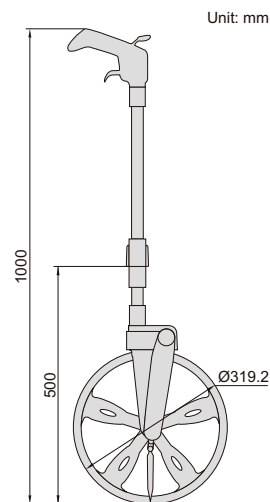

after folding



backpack (included)

Code	Range	Resolution
7145-1	0.1-9999.9m	0.1m

7145-1

RIGID RULE

- Rigid rules
- With groove on the back, suitable for combination square set (2278 series)
- Satin chrome plated



7113-300A



groove on the back

Unit: mm

Code	Range	Graduation		Accuracy	L
		front	back		
7113-300A	300mm/12"	0.5mm and 1/32"	1mm and 1/64"	±0.15mm	300mm

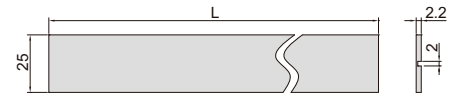

POCKET RULE WITH SLIDING CLIP

- With sliding clip, clip also can be used as depth gage base
- Inch/metric conversion table on the back
- Made of stainless steel



7119-150

Unit: mm

Code	Range	Graduation	Accuracy
7119-150	150mm/6"	1mm, 1/64"	±0.15mm

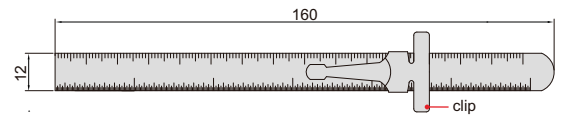

11

ATTENTION:
LOW ACCURACY

STEEL RULES (ECONOMIC TYPE)



7110-300

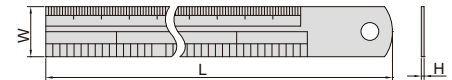

(mm)

Code	Range	Accuracy	L	W	H	Remark
7110-150	150mm/6"	±0.15mm	170	18	1.0	graduation on front and back
7110-200	200mm/8"	±0.15mm	220	18	1.0	graduation on front and back
7110-300	300mm/12"	±0.15mm	330	25	1.0	graduation on front and back
7110-3001	300mm/12"	±0.15mm	325	30	1.0	graduation on front and back
7110-500	500mm/20"	±0.15mm	530	30	1.2	graduation on front and back
7110-600	600mm/24"	±0.20mm	630	30	1.2	graduation on front and back
7110-1000	1000mm/40"	±0.20mm	1040	32	1.5	graduation on front and back
7110-1200	1200mm/48"	±0.22mm	1240	35	1.8	graduation on front
7110-1500	1500mm/60"	±0.25mm	1550	38	1.8	graduation on front
7110-2000	2000mm/80"	±0.30mm	2065	40	2.0	graduation on front

- Graduation: 0.5mm, 1mm, 1/64", 1/32", 1/16"
- Rigid rules
- Made of stainless steel
- Non-glare surface

ALUMINUM RULES

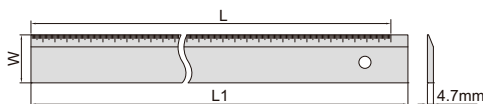

- Made of aluminum, oxidized surface

Code	Range (L)	Graduation	Accuracy	L1	W
7123-300	300mm	1mm	±0.5mm	321mm	50mm
7123-600	600mm	1mm	±0.9mm	624mm	50mm
7123-1000	1000mm	1mm	±0.9mm	1024mm	50mm



7123-300

STRAIGHT EDGES



7111-300A

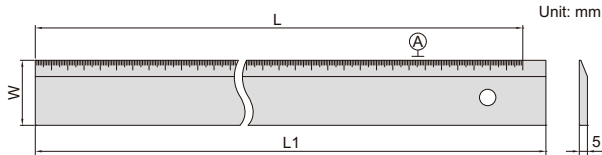

- Check flatness and straightness, as well as for marking
- Graduation on the beveled edge
- Made of hardened tool steel
- Chrome plated

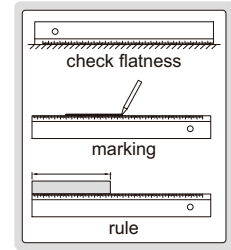

Code	Range (L)	Straightness of A	L1	W
7111-300A	300mm	0.02mm	320mm	40mm
7111-500A	500mm	0.03mm	520mm	40mm
7111-1000A	1000mm	0.04mm	1020mm	50mm

MARKING GAGES



7120-200A

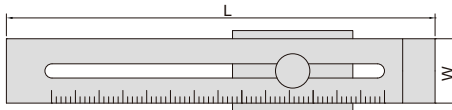

- Made of carbon steel
- Satin chrome plated

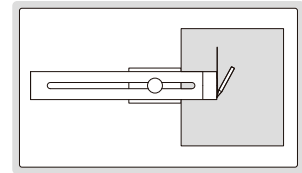

Code	Range	Graduation	Accuracy	L	W
7120-200A	0-200mm	0.1mm	±0.1mm	250mm	40mm
7120-250A	0-250mm	0.1mm	±0.1mm	300mm	40mm
7120-300A	0-300mm	0.1mm	±0.1mm	350mm	40mm

T-SHAPE MARKING GAGE

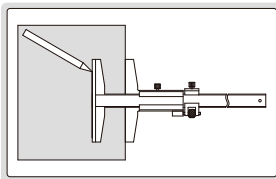

1275-150A

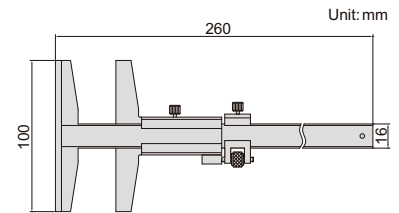

- Made of stainless steel
- Satin chrome plated reading surface

Code	Range	Graduation	Accuracy
1275-150A	0-150mm	0.05mm	±0.05mm

COMBINATION SQUARE (ECONOMIC TYPE)

- Square head (made of zinc): set the blade at 90° or 45° on an edge of a workpiece accuracy: ±0.5°
- Blade (made of stainless steel): range: 300mm/12", graduation: 1mm and 1/32" on front face, 1mm and 1/16" on back face

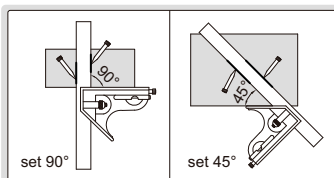

2276-300

Code
2276-300

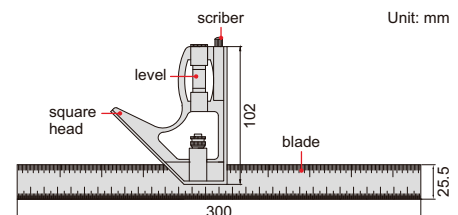

COMBINATION SQUARE SETS

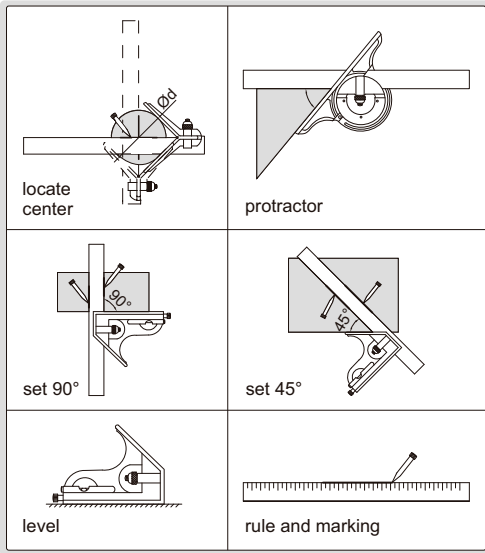
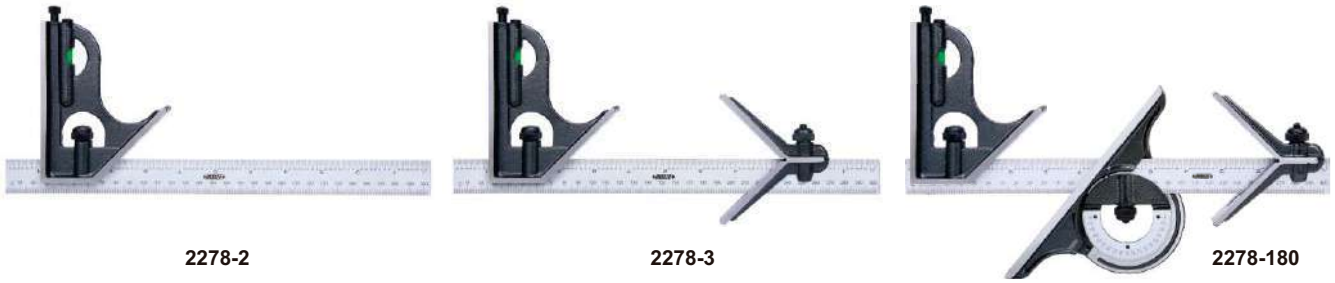

- Center head (made of cast iron): to locate center of cylinders with diameter (Ød): 30-100mm accuracy: ±0.15mm
- Protractor head (made of cast iron): set the blade at desired angle to an edge of a workpiece, and can be used to measure angles range: 0-180° accuracy: ±20min.
- Square head (made of cast iron): set the blade at 90° or 45° to an edge of a workpiece accuracy: ±8min for 90° square, ±10min for 45° square
- Blade (made of stainless steel): range: 300mm/12", graduation: 0.5mm and 1/32" on front face, 1mm and 1/64" on back face
- Optional accessory: rigid rule (code 7113)

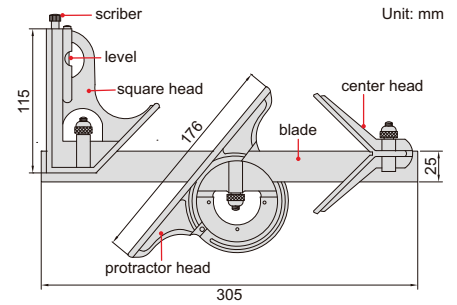

Code	Remark
2278-2	2-piece set
2278-3	3-piece set
2278-180	4-piece set

CENTER MARKING GAGES

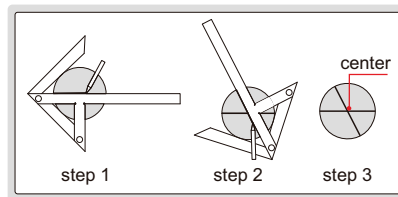
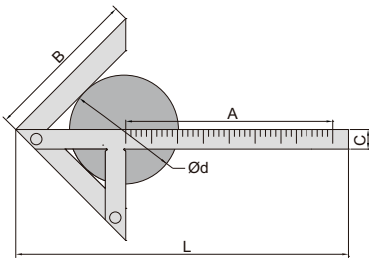

7205-100

Code	Size (AxB)	Diameter of shafts (Ød)	Accuracy	C	L
7205-100	100x70mm	4-90mm	±0.15mm	12mm	153mm
7205-150	150x130mm	4-190mm	±0.15mm	15mm	245mm
7205-200	200x150mm	6-220mm	±0.15mm	15mm	310mm

- Marking the center of round plates and shafts
- Made of stainless steel
- Satin chrome plated

SCRIBING CALIPER

- Made of stainless steel
- Satin chrome plated reading surface
- Carbide scriber tip
- Optional accessory: carbide scriber tip (code SP-SCRIBER-7202)

the position of scriber tip can be adjusted



7202-200A

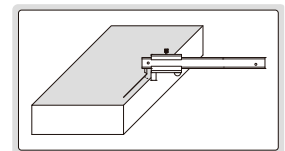
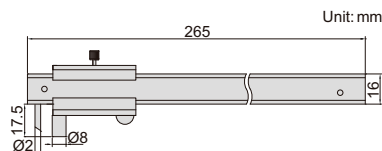

Code	Range	Graduation	Accuracy
7202-200A	0-200mm/0-8"	0.1mm, 1/128"	±0.1mm

DIGITAL SCRIBING CALIPERS (NON-WATERPROOF)

DATA OUTPUT

- The carbide-tipped jaws facilitate scribing on workpieces
- Resolution: 0.01mm/0.0005"
- Buttons: on/off, zero, mm/inch
- Automatic power off, move the digital unit to turn on power
- Battery CR2032, data output
- Made of stainless steel
- Optional accessory: data output cable (code 7315-, 7302-, 7305-)



1166-150A

Code	Range	Accuracy	L	a	b	c	d1	d2
1166-150A	0-150mm/0-6"	±0.03mm	236	21	16.5	16	40	33
1166-200A	0-200mm/0-8"	±0.03mm	286	24	19.5	16	50	43
1166-300A	0-300mm/0-12"	±0.04mm	400	25	20.5	17	60	53

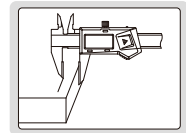
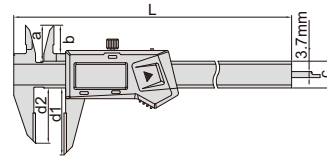

SCRIBING CALIPER

11

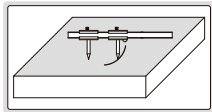

7203-300A

- Made of stainless steel
- Satin chrome plated reading surface
- Hardened scriber tips

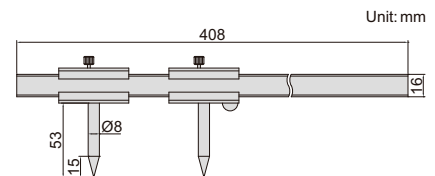

Code	Range	Graduation	Accuracy
7203-300A	51-300mm	0.1mm	±0.1mm

HEIGHT SCRIBER

- Grooved bottom for cylinders
- Two pins to be set against the edge of surface plate



6990-300A

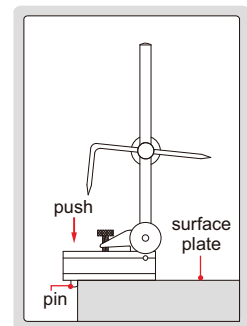
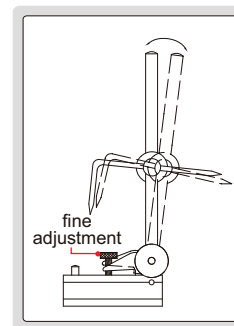
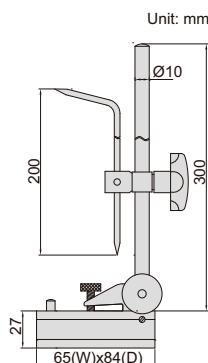

Code
6990-300A

SCRIBERS

- Nickel plated



7230



7231



7232

Code	Tip
7230	hardened tips
7231	hardened tip
7232	carbide tip

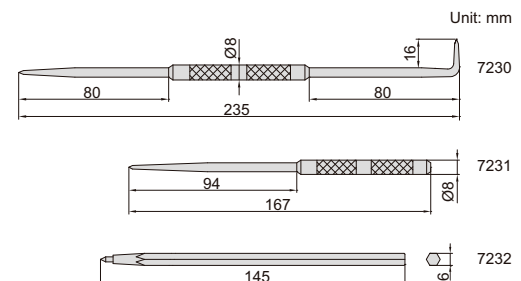

2-PIECE MEASURING TOOL SETS

- Includes:
 - 1) Vernier caliper, range 0-150mm/0-6", graduation 0.05mm/1/128" (code **1205-150S**) for **5021**, graduation 0.02mm/0.001" (code **1205-1502S**) for **5021-2**
 - 2) Outside micrometer, range 0-25mm, graduation 0.01mm (code **3202-25A**)



5021

Code	Remark
5021	Vernier caliper, graduation 0.05mm/1/128" (code 1205-150S)
5021-2	Vernier caliper, graduation 0.02mm/0.001" (code 1205-1502S)

2-PIECE MEASURING TOOL SET

- Includes:
 - 1) Digital caliper, range 0-150mm/0-6", resolution 0.01mm/0.0005" (code **1108-150**)
 - 2) Digital outside micrometer, range 0-25mm/0-1", resolution 0.001mm/0.00005" (code **3109-25A**)



5022

Code
5022

2-PIECE MEASURING TOOL SET

- Includes:
 - 1) Dial test indicator, range 0.8mm, graduation 0.01mm (code **2380-08**)
 - 2) Magnetic stand



5023

Code
5023

2-PIECE MEASURING TOOL SET

- Includes:
 - 1) Dial indicator, range 10mm, graduation 0.01mm (code **2308-10A**)
 - 2) Magnetic stand (code **6201-60**)



5024

Code
5024

3-PIECE MEASURING TOOL SET

- Includes:
 - 1) Digital indicator, range 12.7mm/0.5", resolution 0.01mm/0.0005" (code **2112-10**)
 - 2) Flex arm
 - 3) Locking pliers, adjustable jaw opening from 0 to 25mm



5031

Code

5031

4-PIECE MEASURING TOOL SETS

- Includes:
 - 1) Vernier caliper, range 0-150mm/0-6", graduation 0.05mm/1/128" (code **1205-150S**) for **5041**, graduation 0.02mm/0.001" (code **1205-1502S**) for **5041-2**
 - 2) Outside micrometer, range 0-25mm, graduation 0.01mm (code **3202-25A**)
 - 3) 90° beveled edge square, 100x70mm, grade 0 (code **4790-1000**)
 - 4) Steel rule, 150mm/6" (code **7110-150**)



5041

Code	Remark
5041	Vernier caliper, graduation 0.05mm/1/128" (code 1205-150S)
5041-2	Vernier caliper, graduation 0.02mm/0.001" (code 1205-1502S)

4-PIECE MEASURING TOOL SET

- Includes:
 - 1) Digital caliper, range 0-150mm/0-6", resolution 0.01mm/0.0005" (code **1108-150**)
 - 2) Outside micrometer, range 0-25mm, graduation 0.01mm, (code **3202-25A**)
 - 3) 90° beveled edge square, 100x70mm, grade 0 (code **4790-1000**)
 - 4) Steel rule, 150mm/6" (code **7110-150**)



5042

Code

5042

5-PIECE MEASURING TOOL SET

- Includes:
 - 1) Digital caliper, range 0-150mm/0-6", resolution 0.01mm/0.0005", (code **1108-150**)
 - 2) Outside micrometer, range 0-25mm, graduation 0.01mm (code **3203-25A**)
 - 3) Dial indicator, range 10mm, graduation 0.01mm (code **2308-10A**)
 - 4) Magnetic stand (code **6201-60**)
 - 5) Micrometer stand (code **6300**)



5051

Code

5051

5-PIECE MEASURING TOOL SET

- Includes:
 - 1) Digital caliper, range 0-150mm/0-6", resolution 0.01mm/0.0005" (code **1108-150**)
 - 2) Digital outside micrometer, range 0-25mm/0-1", resolution 0.001mm/0.00005" (code **3109-25A**)
 - 3) Digital indicator, range 12.7mm/0.5", resolution 0.01mm/0.0005" (code **2112-10**)
 - 4) Magnetic stand (code **6201-60**)
 - 5) Micrometer stand (code **6300**)

Code

5052



5052

6-PIECE MEASURING TOOL SET

- Includes:
 - 1) Digital caliper, range 0-150mm/0-6", resolution 0.01mm/0.0005" (code **1108-150**)
 - 2) Outside micrometer, range 0-25mm, graduation 0.01mm (code **3202-25A**)
 - 3) Dial indicator, range 10mm, graduation 0.01mm (code **2308-10FA**)
 - 4) 90° beveled edge square, 100x70mm, grade 0 (code **4790-1000**)
 - 5) Scriber (code **7230**)
 - 6) Steel rule, 150mm/6" (code **7110-150**)

Code

5061



5061

6-PIECE MEASURING TOOL SET

- Includes:
 - 1) Digital caliper, range 0-150mm/0-6" resolution 0.01mm/0.0005" (code **1108-150**)
 - 2) Outside micrometer, range 0-25mm graduation 0.01mm (code **3202-25A**)
 - 3) 90° beveled edge square, 100x70mm grade 00 (code **4790-0100**)
 - 4) Straight edge, 100mm (code **4700-100**)
 - 5) Spring divider, 150mm (code **7260-150**)
 - 6) Steel rule, 200mm/8" (code **7110-200**)

Code

5062



5062

6-PIECE MEASURING TOOL SETS

Includes:

- 1) Vernier caliper, range 0-150mm/0-6", graduation 0.05mm/1/128" (code **1205-150S**) for **5063**, graduation 0.02mm/0.001" (code **1205-1502S**) for **5063-2**
- 2) Outside micrometer, range 0-25mm graduation 0.01mm (code **3202-25A**)
- 3) 90° beveled edge square, 100x70mm grade 00 (code **4790-0100**)
- 4) Straight edge, 100mm (code **4700-100**)
- 5) Spring divider, 150mm (code **7260-150**)
- 6) Steel rule, 200mm/8" (code **7110-200**)



5063

Code	Remark
5063	Vernier caliper, graduation 0.05mm/1/128" (code 1205-150S)
5063-2	Vernier caliper, graduation 0.02mm/0.001" (code 1205-1502S)

9-PIECE MEASURING TOOL SET

Includes:

- 1) Digital caliper, range 0-150mm/0-6", resolution 0.01mm/0.0005" (code **1108-150**)
- 2) Outside micrometer, range 0-25mm, graduation 0.01mm (code **3202-25A**)
- 3) Protractor, range 0-180°, graduation 1° (code **4799-180**)
- 4) Pitch gauge, range 0.25-7mm, 24pcs, metric 60° thread (code **4820-124**)
- 5) Radius gauge, range 1-7mm (code **4801-17**)
- 6) Feeler gauge, range 0.05-1.00mm, 20pcs (code **4602-20**)
- 7) 90° beveled edge square, 100x70mm, grade 0 (code **4790-1000**)
- 8) Scriber (code **7230**)
- 9) Steel rule, 150mm/6" (code **7110-150**)



5091

Code
5091

13-PIECE MEASURING TOOL SET

Includes:

- 1) Digital caliper, range 0-150mm/0-6", resolution 0.01mm/0.0005", (code **1108-150**)
- 2) Outside micrometer, range 0-25mm, graduation 0.01mm (code **3202-25A**)
- 3) Dial indicator, range 10mm, graduation 0.01mm (code **2308-10A**)
- 4) Magnetic stand (code **6201-60**)
- 5) Protractor, range 0-180°, graduation 1° (code **4799-180**)
- 6) Pitch gauge, range 0.25-7mm, 24pcs, metric 60° thread (code **4820-124**)
- 7) Radius gauge, range 1-7mm (code **4801-17**)
- 8) Feeler gauge, range 0.05-1.00mm, 20pcs (code **4602-20**)
- 9) 90° beveled edge square, 100x70mm, grade 0 (code **4790-1000**)
- 10) Scriber (code **7230**)
- 11) Steel rule, 150mm/6" (code **7110-150**)
- 12) Depth base attachment (code **6140**)
- 13) Zero setting bar for depth base attachment



5013

Code
5013



**CUSTOM-MADE
SUPPLY SPECIAL SIZES ACCORDING
TO CUSTOMER'S REQUEST**



GRANITE SURFACE PLATES

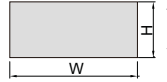
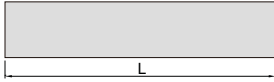

- Made of granite, free from deterioration or dimensional change over time, minimal changes in dimension due to temperature changes
- Meet DIN876, grade 00 is for inspection room or lab, grade 0 is for workshop
- Optional accessory: stand for granite surface plate (code **6902**), jack for granite surface plate (code **6903**)



6900-132

Grade 00

Code	Size (LxWxH)	Flatness	Weight	Max. load
6900-132*	300x200x60mm	2.7µm	11kg	30kg
6900-142*	400x250x60mm	2.9µm	18kg	50kg
6900-144*	400x400x60mm	3.1µm	29kg	60kg
6900-153*	500x315x70mm	3.2µm	33kg	60kg
6900-164*	630x400x80mm	3.5µm	60kg	65kg
6900-166*	630x630x100mm	3.8µm	119kg	75kg
6900-185*	800x500x100mm	3.9µm	120kg	100kg
6900-1106*	1000x630x140mm	4.4µm	265kg	200kg
6900-1101*	1000x1000x150mm	4.8µm	450kg	400kg
6900-1128*	1200x800x160mm	4.9µm	461kg	500kg
6900-1161*	1600x1000x180mm	5.8µm	864kg	600kg
6900-1201*	2000x1000x220mm	6.5µm	1320kg	650kg
6900-1202*	2000x1500x250mm	7.0µm	2250kg	750kg

Grade 0

Code	Size (LxWxH)	Flatness	Weight	Max. load
6900-032*	300x200x60mm	5.4µm	11kg	60kg
6900-042*	400x250x60mm	5.9µm	18kg	100kg
6900-044*	400x400x60mm	6.3µm	29kg	120kg
6900-053*	500x315x70mm	6.4µm	33kg	120kg
6900-064*	630x400x80mm	7.0µm	60kg	130kg
6900-066*	630x630x100mm	7.6µm	119kg	150kg
6900-085*	800x500x100mm	7.8µm	120kg	200kg
6900-0106*	1000x630x140mm	8.7µm	265kg	400kg
6900-0101*	1000x1000x150mm	9.7µm	450kg	800kg
6900-0128*	1200x800x160mm	9.8µm	461kg	1000kg
6900-0161*	1600x1000x180mm	11.5µm	864kg	1200kg
6900-0201*	2000x1000x220mm	12.9µm	1320kg	1300kg
6900-0202*	2000x1500x250mm	14.0µm	2250kg	1500kg

*Supplied with manufacturer inspection certificate

12

- For medium size granite surface plates
- 5 jacks are included
- Adjusting range of jacks: 25mm
- One foot on the bottom is adjustable



STANDS FOR GRANITE SURFACE PLATES

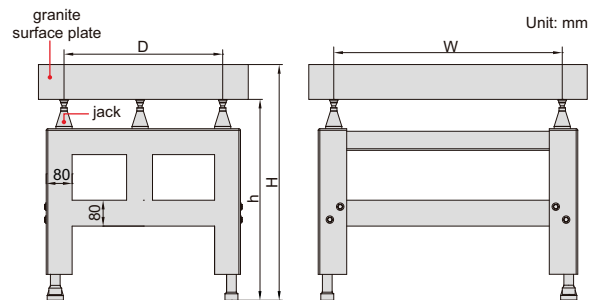

Low stands

Code	For granite surface plate	W	D	H (with granite surface plate)	h (without granite surface plate)
6902-64A	630x400x80mm (code 6900-064 and 6900-164)	352	224	775-800	695-720
6902-66A	630x630x100mm (code 6900-066 and 6900-166)	352	352	775-800	675-700
6902-85A	800x500x100mm (code 6900-085 and 6900-185)	448	280	775-800	675-700
6902-106A	1000x630x140mm (code 6900-0106 and 6900-1106)	560	352	755-780	615-640
6902-101A	1000x1000x150mm (code 6900-0101 and 6900-1101)	560	560	755-780	605-630
6902-128A	1200x800x160mm (code 6900-0128 and 6900-1128)	672	448	755-780	595-620
6902-161A	1600x1000x180mm (code 6900-0161 and 6900-1161)	896	560	755-780	575-600

High stands

Code	For granite surface plate	W	D	H (with granite surface plate)	h (without granite surface plate)
6902-64H	630x400x80mm (code 6900-064 and 6900-164)	352	224	1000-1025	920-945
6902-66H	630x630x100mm (code 6900-066 and 6900-166)	352	352	1000-1025	900-925
6902-85H	800x500x100mm (code 6900-085 and 6900-185)	448	280	1000-1025	900-925
6902-106H	1000x630x140mm (code 6900-0106 and 6900-1106)	560	352	1000-1025	860-885
6902-101H	1000x1000x150mm (code 6900-0101 and 6900-1101)	560	560	1000-1025	850-875
6902-128H	1200x800x160mm (code 6900-0128 and 6900-1128)	672	448	1000-1025	840-865
6902-161H	1600x1000x180mm (code 6900-0161 and 6900-1161)	896	560	1000-1025	820-845

JACK SET FOR GRANITE SURFACE PLATES

- 5 jacks per set
- Adjustable height
- For large granite surface plates:
 - 2000x1000x220mm (code **6900-0201** and **6900-1201**)
 - 2000x1500x250mm (code **6900-0202** and **6900-1202**)

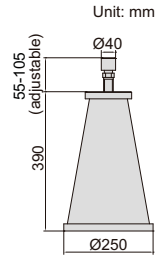

Code
6903-B

6903-B

MAGNETIC RECTANGULAR BLOCKS

HARDENED SURFACES

HIGH PRECISION

STRONG MAGNETIC FORCE

- For grinding, light milling, drilling and inspection of round and square jobs
- Hardened, high accuracy, strong magnetic force
- Working surfaces are hardened to HRC58-62
- Magnetic force on top, bottom and back sides
- Supplied in matched pair

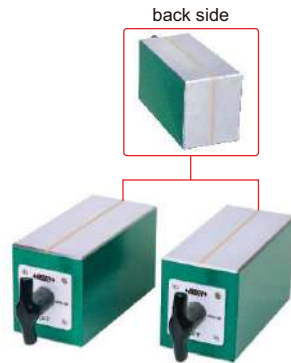

6898-150

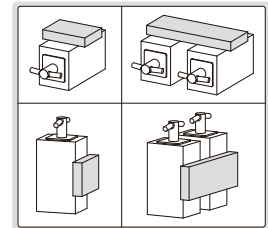
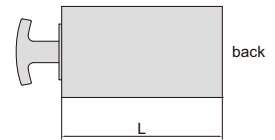
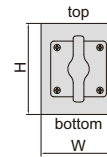

Code	Size (LxWxH)	Magnetic force	Parallelism of top to bottom side	Squareness of top and bottom to back side	Height difference of a matched pair
6898-100	100x70x70mm	100kgf	5µm	5µm	5µm
6898-150	150x70x85mm	125kgf	5µm	5µm	5µm

V-BLOCK SETS

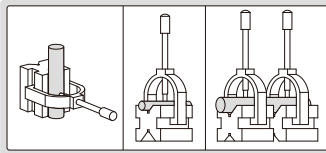

- Hold cylindrical workpieces for inspection and machining
- Two V-blocks per set
- Made of alloy steel
- Hardened to HRC60±2
- V groove on the top for large shafts
- V groove on the bottom for small shafts (except **6896-10**)



6896-10

6896-11

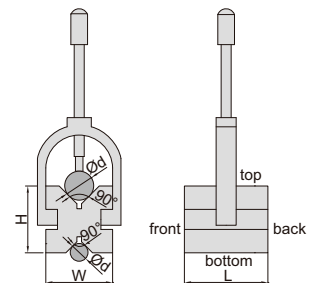

Code	Size (LxWxH)	Range of shafts (Ød)	Parallelism of both V grooves to top and bottom sides	Squareness of both V grooves to front and back sides	Height difference of a matched pair
6896-10	25x20x20mm	3-20mm	3µm	3µm	3µm
6896-11	50x40x40mm	5-30mm	5µm	5µm	5µm
6896-12	80x63x63mm	7-63mm	5µm	5µm	5µm
6896-13	100x80x80mm	7-80mm	5µm	5µm	5µm
6896-14	70x140x140mm	9-140mm	5µm	5µm	5µm

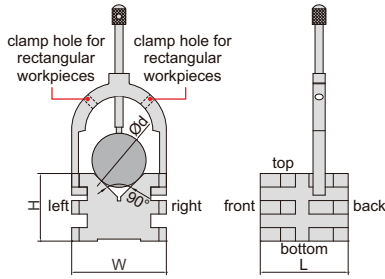

- Hold cylindrical or rectangular workpieces for inspection and machining
- Two V-blocks per set
- Made of alloy steel
- Hardened to HRC60±2
- Applicable for cylinder with diameter (Ød): 5-50mm
- Applicable for rectangular workpieces with thickness: ≤35mm



6802-1

SIDE LIE-DOWN USE IS POSSIBLE

V-BLOCK SET

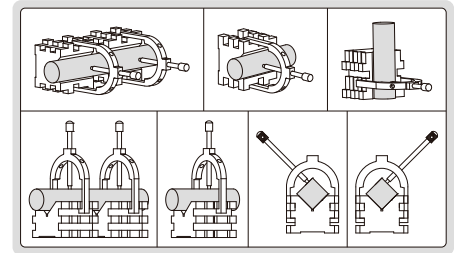

Code	Size (LxWxH)	Parallelism of V groove to top, bottom, left, right sides	Squareness of V groove to front and back sides	Height difference of a matched pair
6802-1	65x70x50mm	5µm	5µm	5µm

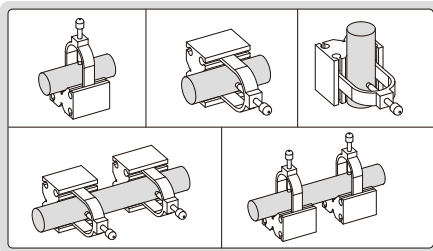

- Hold cylindrical workpieces for inspection and machining
- Two V-blocks per set
- Made of alloy steel
- Hardened to HRC60±2
- V groove on the top for large shafts
- V groove on the bottom for small shafts



6803-1

SIDE LIE-DOWN USE IS POSSIBLE

V-BLOCK SETS

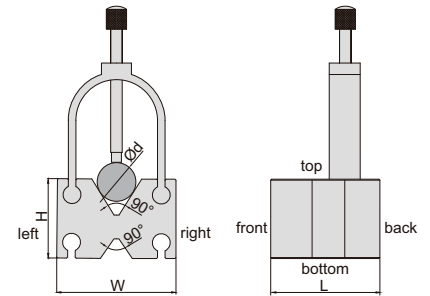

Code	Size (LxWxH)	Range of shafts (Ød)	Parallelism of both V grooves to top, bottom, left, right sides	Squareness of both V grooves to front and back sides	Height difference of a matched pair
6803-1	55x60x40mm	4-35mm	5µm	5µm	5µm
6803-2	65x70x45mm	4-47mm	5µm	5µm	5µm



6804-M2

- Hold cylindrical workpieces for inspection and machining
- Made of alloy steel
- Hardened to HRC60±2

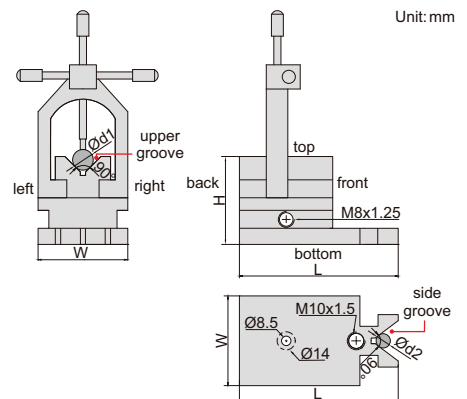

Code	Size (LxWxH)	Range of shafts (Ød1 and Ød2)	Parallelism of upper groove to bottom, left and right sides	Squareness of upper groove to back side	Parallelism of side groove to back side
6804-M2	90x48x48mm	5-33mm	5µm	5µm	5µm

V-BLOCK SETS

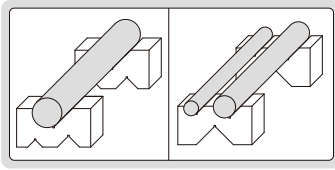

6887-3

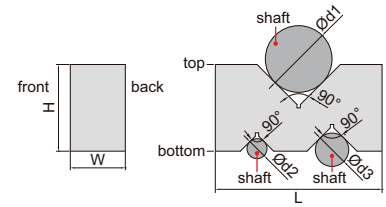

- Two V-blocks per set
- Made of hardened tool steel

(mm)

Code	Size (LxWxH)	Range of shafts (Ød1)	Range of shafts (Ød2)	Range of shafts (Ød3)
6887-1	50x19x24	3-32	3-16	3-22
6887-2	75x24x35	3-50	3-20	3-32
6887-3	100x33x52	3-68	3-26	3-40
6887-4	125x44x69	3-87	3-34	3-50

Code	Parallelism of three V grooves to top and bottom sides	Height difference of a matched pair
6887-1	5µm	5µm
6887-2	5µm	5µm
6887-3	5µm	5µm
6887-4	5µm	5µm

ROLLER BEARING V-BLOCK SETS

12

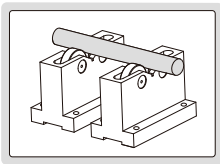

6888-1

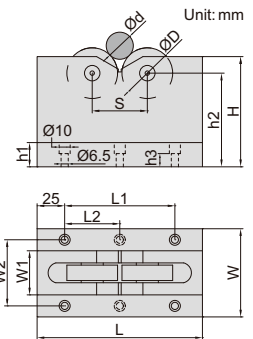

- Runout accuracy: 5µm
- Parallelism of bearings to bottom: 12µm
- Two V-blocks per set
- Workpieces don't get damaged due to bearings
- Suitable for heavy workpieces

Code	Size (LxWxH)	Code of bearings	Diameter of bearings (ØD)	Range of shafts (Ød)	Load capacity
6888-1	150x60x100mm	6303 ZZ	42mm	25-70mm	500kg
6888-2	150x80x100mm	16004 ZZ	47mm	5-55mm	1000kg
6888-3	230x100x150mm	6306 ZZ	72mm	70-200mm	1000kg

(mm)

Code	W1	W2	h1	h2	h3	L1	L2	S
6888-1	22	44	20	85	12	100	-	60
6888-2	40	60	22	85	12	100	-	50
6888-3	60	80	30	124	20	180	90	120

GRANITE V-BLOCK SETS

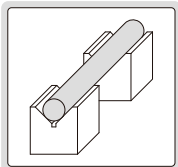

6897-1

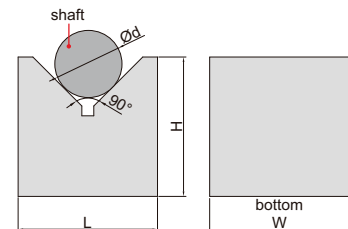

- Two V-blocks per set

Code	Size (LxWxH)	Range of shafts (Ød)	Parallelism of V groove to bottom	Height difference of a matchet pair
6897-1	70x50x70mm	6-75mm	4µm	5µm
6897-2	100x50x70mm	6-99mm	4µm	5µm

HARDENED SURFACES

HIGH PRECISION

STRONG MAGNETIC FORCE

MAGNETIC V-BLOCKS (ADVANCED TYPE)

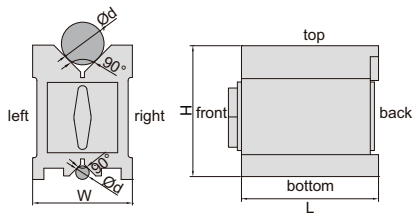

6889-11



6889-1

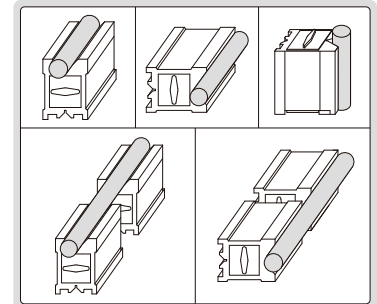

- Hardened, high accuracy, strong magnetic force, for grinding, light milling, drilling and inspection of round and square workpieces
- All working surfaces are hardened to HRC60±2
- Magnetic force on top, bottom and two V grooves
- V groove on the top for large shafts
- V groove on the bottom for small shafts
- Suitable for cast iron surface plates and granite surface plates

Individual

Code	Size (LxWxH)	Range of shafts (Ød)	Magnetic force	Parallelism of V groove to top, bottom, left, right sides	Squareness of V groove to back side
6889-11	75x56x75mm	5-40mm	85kgf	5µm	5µm
6889-22	100x70x95mm	5-65mm	150kgf	5µm	5µm
6889-33	150x75x100mm	5-70mm	190kgf	6µm	6µm
6889-55	160x125x130mm	5-140mm	220kgf	12µm	12µm
6889-44	200x125x150mm	10-140mm	400kgf	12µm	12µm

Matched pair

Code	Size (LxWxH)	Range of shafts (Ød)	Magnetic force	Parallelism of V grooves to top, bottom, left, right sides	Squareness of V grooves to back side	Height difference of a matched pair
6889-1	75x56x75mm	5-40mm	85kgf	5µm	5µm	5µm
6889-2	100x70x95mm	5-65mm	150kgf	5µm	5µm	5µm
6889-3	150x75x100mm	5-70mm	190kgf	6µm	6µm	6µm
6889-5	160x125x130mm	5-140mm	220kgf	12µm	12µm	12µm
6889-4	200x125x150mm	10-140mm	400kgf	12µm	12µm	12µm

12

ATTENTION: NOT SUITABLE FOR STEEL OR IRON SURFACES, OTHERWISE THE MAGNETIC FORCE WILL BE REDUCED

ATTENTION: NOT HARDENED

MAGNETIC V-BLOCK

- Hold cylindrical workpieces for inspection and machining
- Supplied in single piece
- Not hardened
- Not suitable for steel or iron surfaces, otherwise the magnetic force will be reduced

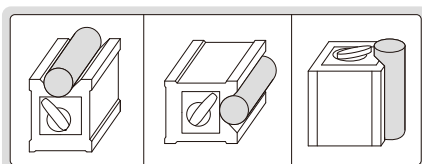

6890-702

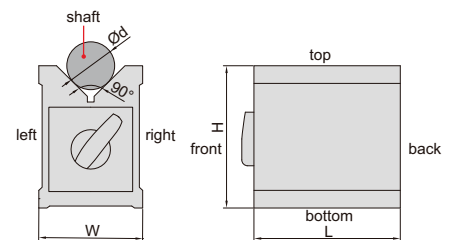

Code	Size (LxWxH)	Range of shafts (Ød)	Magnetic force	Parallelism of V groove to top, bottom, left and right sides	Squareness of V groove to back side
6890-702	70x60x73mm	6-44mm	56kgf	10µm	10µm

MAGNETIC V-BLOCKS

ATTENTION: NOT SUITABLE FOR STEEL OR IRON SURFACES, OTHERWISE THE MAGNETIC FORCE WILL BE REDUCED

ATTENTION: NOT HARDENED

- Hold cylindrical workpieces for inspection and machining
- Supplied in single piece
- Not hardened
- V groove on the top for large shafts
- V groove on the bottom for small shafts
- Not suitable for steel or iron surfaces, otherwise the magnetic force will be reduced

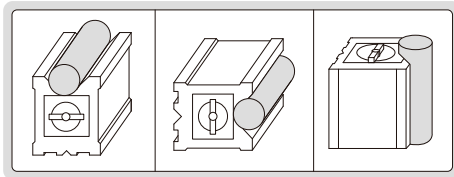

6801-1201

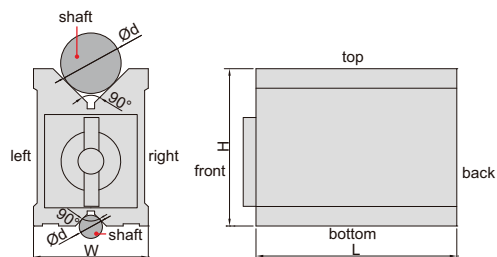

Code	Size (LxWxH)	Range of shafts ($\varnothing d$)	Magnetic force	Parallelism of V grooves to top, bottom, left, right side	Squareness of V grooves to back side
6801-1201	80x70x95mm	6-67mm	64kgf	10 μ m	10 μ m
6801-1202	100x70x95mm	6-67mm	80kgf	10 μ m	10 μ m
6801-1203	120x70x95mm	6-67mm	96kgf	10 μ m	10 μ m

12

MAGNETIC V-BLOCK SETS

ATTENTION: LOW MAGNETIC FORCE

ATTENTION: NOT HARDENED SURFACE, DO NOT ROTATE WORKPIECES ON V-BLOCKS

- Hold cylindrical workpieces for inspection, not suitable for machining due to low magnetic force
- Two V-blocks per set
- Hardness HRB70



6891-1

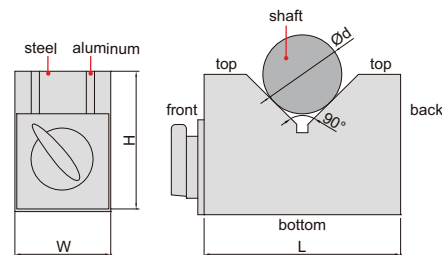

Code	Size (LxWxH)	Range of shafts ($\varnothing d$)	Magnetic force	Parallelism of V groove to bottom and back sides	Height difference of a matched pair
6891-1	70x40x50mm	6-46mm	8kgf	10 μ m	10 μ m
6891-3	150x50x100mm	6-125mm	14kgf	10 μ m	10 μ m

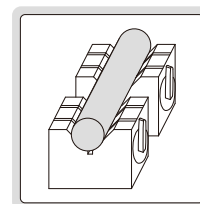

MAGNETIC INDUCTION V-BLOCK

ATTENTION: NOT HARDENED SURFACE, DO NOT ROTATE WORKPIECES ON V-BLOCKS

- Hold cylindrical workpieces for inspection and machining
- To be used on magnetic chucks
- Supplied in single piece
- V groove on the top for large shafts
- V groove on the bottom for small shafts
- Hardness HRB70



6892-1

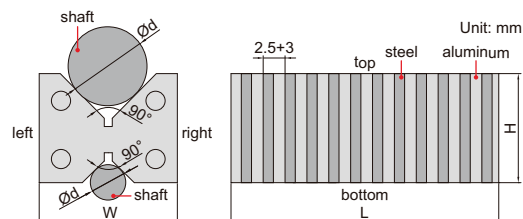

Code	Size (LxWxH)	Range of shafts ($\varnothing d$)	Pole pitch	Parallelism of both V grooves to top, bottom, left, right sides
6892-1	110x60x48mm	6-50mm	2.5+3mm	10 μ m

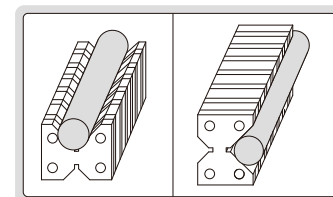

ATTENTION: NOT HARDENED SURFACE, DO NOT ROTATE WORKPIECES ON V-BLOCKS

MAGNETIC INDUCTION V-BLOCK SET

- Hold cylindrical workpieces for inspection and machining
- To be used on magnetic chucks
- Two V-blocks per set
- V groove on the top for large shafts
- V groove on the bottom for small shafts
- Hardness HRB70

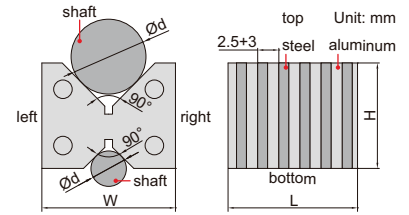

6899-1

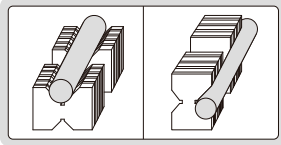

Code	Size (LxWxH)	Range of shafts (Ød)	Pole pitch	Parallelism of both V grooves to top, bottom, left and right sides	Height difference of a matched pair
6899-1	55x60x48mm	6-50mm	2.5+3mm	10µm	10µm

PARALLEL SETS

- Parallelism between top and bottom: 5µm
- Height difference of a matched pair: 5µm
- Made of alloy tool steel
- Hardened to HRC55-60

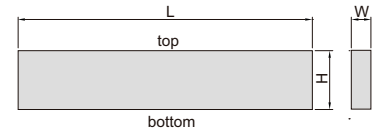

6533-144

Code	Parallels per set	Length (L)	Thickness (W)	Height (H)
6533-10	10 pairs	150mm	3mm	13, 16, 19, 22, 25, 28, 31, 35, 38, 41mm
6533-144	14 pairs	150mm	10mm	14, 16, 18, 20, 22, 24, 26, 28, 30, 32, 35, 40, 45, 50mm
6533-6	6 pairs	200mm	9.5mm	35, 40, 45, 50, 55, 58mm

PARALLEL SET

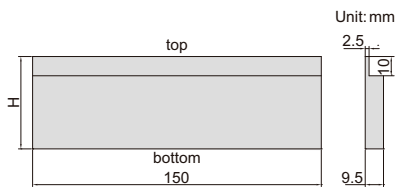

6534-6

- Parallelism between top and bottom: 5µm
- Height difference of a matched pair: 5µm
- Made of alloy tool steel
- Hardened to HRC55-60

Code	Parallels per set	Height (H)
6534-6	6 pairs	25, 30, 35, 40, 45, 48mm

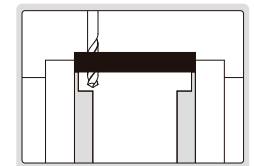

GRANITE PARALLEL SET

- Made of granite, hard and no rusty, no dimensional change over time or temperature change
- Two parallels per set



4143-250

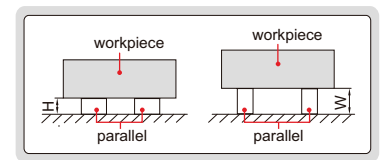

Code	Size (LxWxH)	Parallelism between A and B	Parallelism between C and D	Height difference of a matched pair
4143-250	250x25x40mm	3µm	3µm	3µm

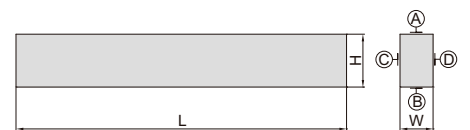

MAGNETIC INDUCTION PARALLEL SETS

ATTENTION:
NOT HARDENED SURFACE

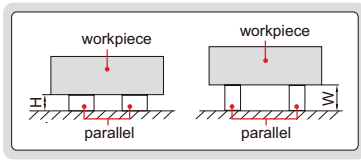

- To be used on magnetic chucks
- Two parallels per set
- Hardness HRB70

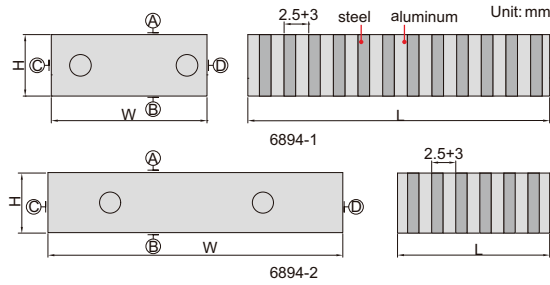

Code	Size (LxWxH)	Pole pitch	Parallelism between A and B	Parallelism between C and D	Height difference of a matched pair
6894-1	100x50x25mm	2.5+3mm	10µm	10µm	10µm
6894-2	50x100x25mm	2.5+3mm	10µm	10µm	10µm

ANGLE PLATE SETS



4003-12

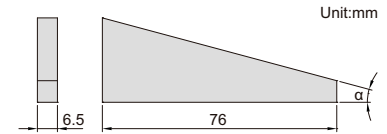

- For angle set-up in tooling, production and inspection
- Made of tool steel
- Hardness HRC55

Code	Angle plates included	Angle α	Accuracy
4003-10	10 pcs	1°, 2°, 3°, 4°, 5°, 10°, 15°, 20°, 25°, 30°	±9"
4003-12	12 pcs	1/4°, 1/2°, 1°, 2°, 3°, 4°, 5°, 10°, 15°, 20°, 25°, 30°	±9"

UNIVERSAL ANGLE PLATE SET



4004-9

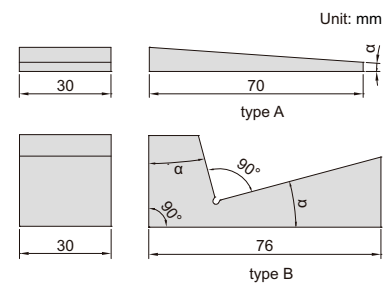

- For angle set-up in tooling, production and inspection
- Made of tool steel
- Hardness HRC55

Code	Angle plates included	Angle α	Type	Accuracy
4004-9	9 pcs	1/2°, 1°, 2°, 3°, 4°, 5°	type A	±30"
		10°, 15°, 30°	type B	±50"

ADJUSTABLE ANGLE BLOCKS



6535-30

- Made of hardened tool steel
- With locking screw
- Accuracy of angle: 10'

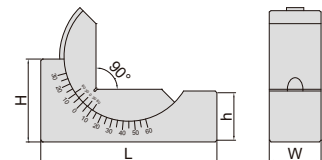

Code	Size (LxWxH)	h	Adjustable angle	Graduation of angle
6535-25	75x25x36mm	25mm	30°~0°~60°	10'
6535-30	102x30x49mm	30mm	30°~0°~60°	10'

RIGHT ANGLE PLATE

Unit: mm

- Made of alloy steel
- Hardened to HRC60±2
- V groove for cylinders
- Parallelism and squareness between A, B, C, D, E, F, G and H: 6µm
- Parallelism and squareness of V groove to A, B, C, D, E, F, G and H: 6µm



6547-1

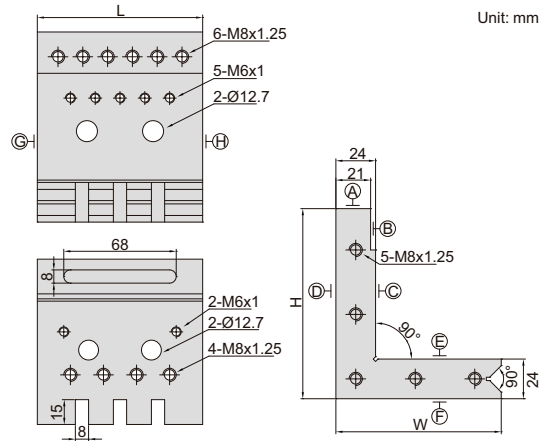

Code	Size (LxWxH)
6547-1	100x100x115mm

RIGHT ANGLE PLATE

Unit: mm

- Made of tool steel
- Hardened to HRC60±2
- Squareness or parallelism between A, B, C and D: 5µm



6548-1

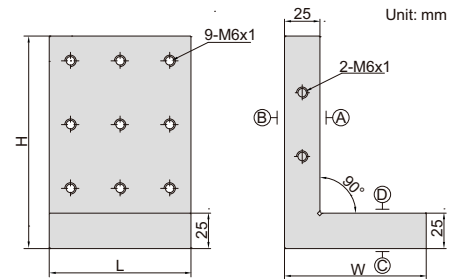

Code	Size (LxWxH)
6548-1	100x100x150mm

RIGHT ANGLE PLATE

Unit: mm

- Made of tool steel
- Hardened to HRC56-58
- Parallelism between A, B, C, D, E and F: 3µm
- Squareness between A, B, C, D, E and F: 5µm



6549-1

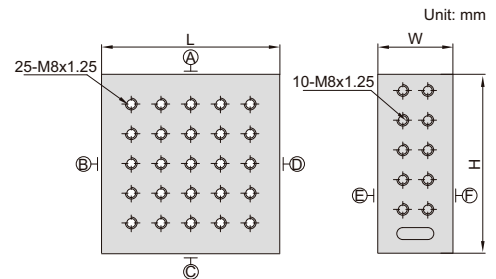

Code	Size (LxWxH)
6549-1	150x63x150mm

- Made of alloy tool steel

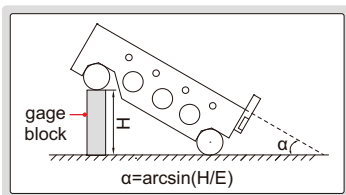

4155-100

HIGH PRECISION

SINE BARS

The front and back ends and two sides have mounting holes to install plate

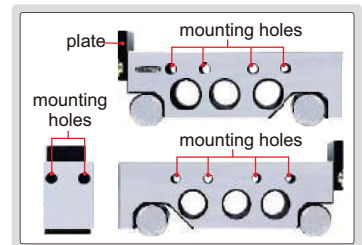

Code	Roller distance (E)	Table size (AxB)	C	Accuracy of α at 30°
4155-100	100	130x30	40	±5 seconds
4155-200	200	230x30	40	±5 seconds
4155-300	300	345x40	50	±8 seconds

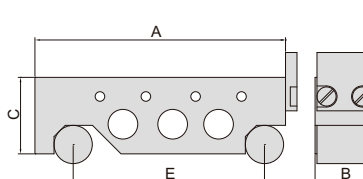

SINE TABLE

- Accuracy of angle: $\pm 15''$
- Made of alloy tool steel
- Hardness HRC58-60



6527-100

Code	Roller distance (E)	Table size (LxW)	Adjustable angle
6527-100	100mm	150x150mm	0-60°

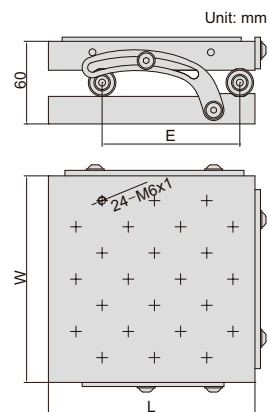

PRECISION SINE VISE

12



6522-80

There is a 1mm step (accuracy $\pm 0.002\text{mm}$). Gage blocks smaller than 0.5mm are not available. If small gage blocks are needed (for example, 0.25mm), a gage block 1.25mm can be used in order to make $1.25\text{mm} - 1\text{mm} = 0.25\text{mm}$.



- Parallelism: $3\mu\text{m}/100\text{mm}$
- Squareness: $5\mu\text{m}/100\text{mm}$
- Accuracy of angle: $\pm 15''$
- Made of SKS tool steel, subzero treatment
- Hardness HRC58-60

Code	Jaw opening (Q)	Jaw width (W)	Adjustable angle
6522-80	0-80mm	73mm	0-46°

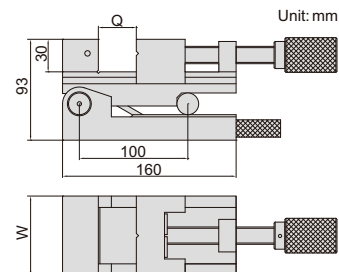

PRECISION SINE VISE

There is a 1mm step (accuracy $\pm 0.002\text{mm}$). Gage blocks smaller than 0.5mm are not available. If small gage blocks are needed (for example, 0.25mm), a gage block 1.25mm can be used in order to make $1.25\text{mm} - 1\text{mm} = 0.25\text{mm}$.



6523-80

- Parallelism: $3\mu\text{m}/100\text{mm}$
- Squareness: $5\mu\text{m}/100\text{mm}$
- Accuracy of angle: $\pm 15''$
- Made of SKS tool steel, subzero treatment
- Hardness HRC58-60

Code	Jaw opening (Q)	Jaw width (W)	Adjustable angle
6523-80	0-80mm	73mm	0-46°

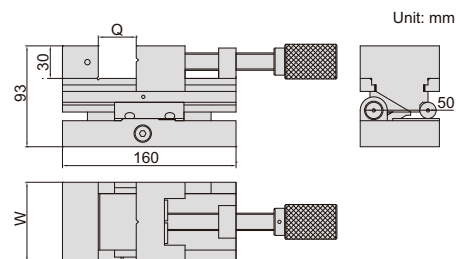

PRECISION COMPOUND SINE VISE

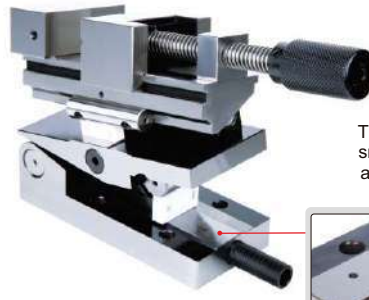
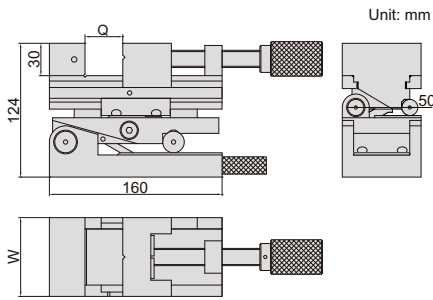

6524-80

There is a 1mm step (accuracy $\pm 0.002\text{mm}$). Gage blocks smaller than 0.5mm are not available. If small gage blocks are needed (for example, 0.25mm), a gage block 1.25mm can be used in order to make $1.25\text{mm} - 1\text{mm} = 0.25\text{mm}$.



- Parallelism: $3\mu\text{m}/100\text{mm}$
- Squareness: $5\mu\text{m}/100\text{mm}$
- Accuracy of angle: $\pm 15''$
- Made of SKS tool steel, subzero treatment
- Hardness HRC58-60

Code	Jaw opening (Q)	Jaw width (W)	Adjustable angle
6524-80	0-80mm	73mm	0-46°

PRECISION UNIVERSAL VISE

- Horizontal rotary: range 360° , graduation 0.05°
- Vertical incline: range 45° , graduation 0.05°
- With incline adjust knob
- Parallelism and squareness between A, B, C and D: $5\mu\text{m}/100\text{mm}$, parallelism between D and E at 0° : $10\mu\text{m}/100\text{mm}$
- Made of tool steel
- Hardness HRC56-58

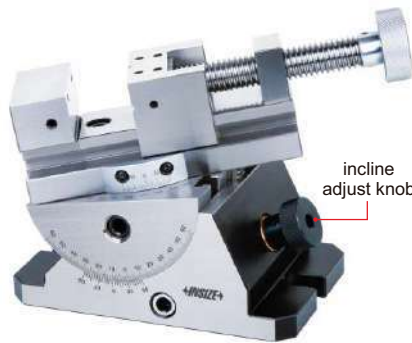

6521-80

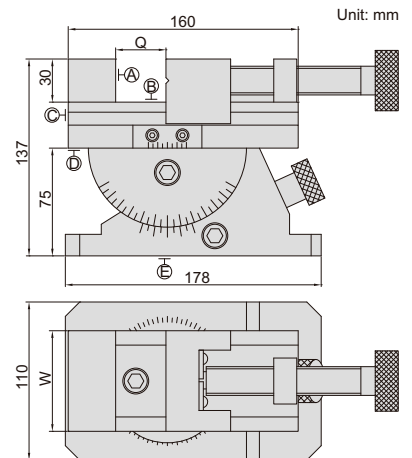

Code	Jaw opening (Q)	Jaw width (W)
6521-80	0-80mm	70mm

PRECISION UNIVERSAL VISE WITH CHUCK

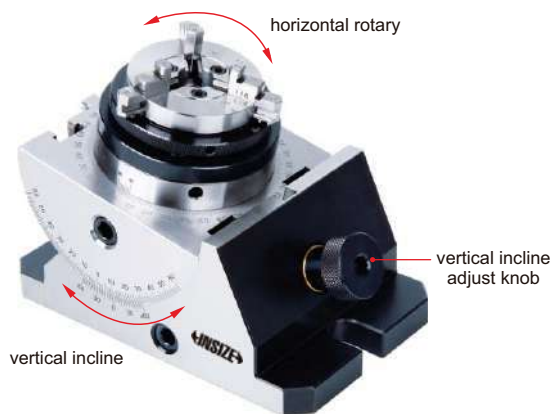

6528-85

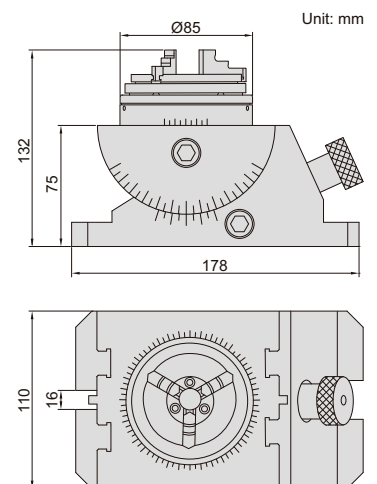

- Horizontal rotary: range 360° , graduation 0.05°
- Vertical incline: range 45° , graduation 0.05°
- With vertical incline adjust knob
- Runout of chuck is less than $8\mu\text{m}$ (test position is at less than 50mm from clamping jaws)
- The clamping jaws of chuck are reversible
- Made of tool steel
- Hardness HRC56-58

Code	Range of external clamping	Range of internal clamping
6528-85	$\varnothing 0.8 \sim \varnothing 63\text{mm}$	$\varnothing 23 \sim \varnothing 58\text{mm}$

PRECISION VISES

- Parallelism: 4µm/100mm
- Squareness: 6µm/100mm
- Made of alloy steel
- Hardness HRC56-58



6525-76

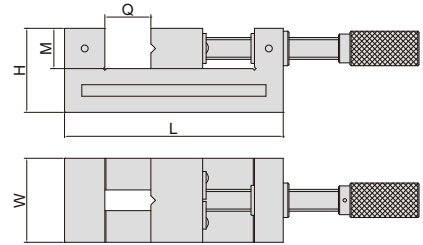

Code	Jaw opening (Q)	Jaw width (W)	L	H	M
6525-73	0-73mm	63mm	176mm	63mm	30mm
6525-76	0-76mm	73mm	190mm	73mm	35mm
6525-120	0-120mm	98mm	255mm	82mm	40mm

PRECISION VISES

- Parallelism: 3µm/100mm
- Squareness: 5µm/100mm
- Made of alloy steel
- Hardness HRC56-58



6526-80

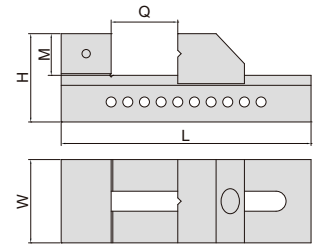

Code	Jaw opening (Q)	Jaw width (W)	Overall length (L)	H	M
6526-80	0-80mm	50mm	150mm	53mm	25mm
6526-100	0-100mm	73mm	190mm	70mm	35mm

12

Z-AXIS STAGE CODE 6586-60

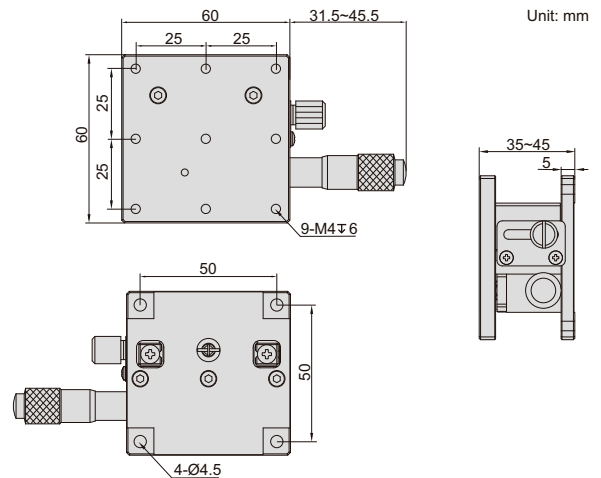

- Cross roller guides, achieve high precision and smooth movement
- Stage made of aluminum alloy

SPECIFICATION

Code	Z-axis displacement	Parallelism of top surface to bottom	Micrometer graduation	Micrometer accuracy	Maximum load	Stage size	Weight
6586-60	10mm	0.05mm	0.01mm	0.02mm	20.4N (3kgf)	60x60mm	0.27kg

X-AXIS STAGES



6582-401

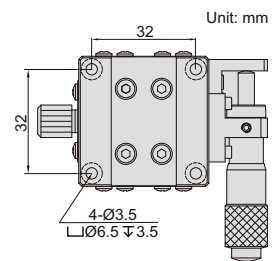
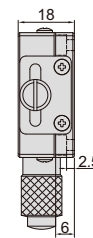
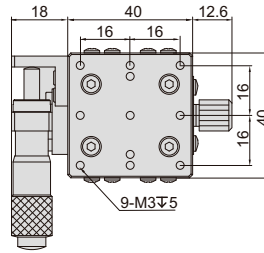

6582-602

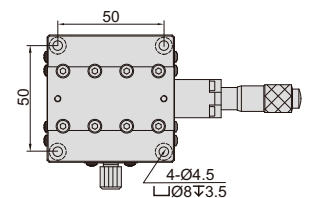
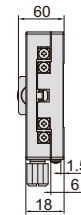
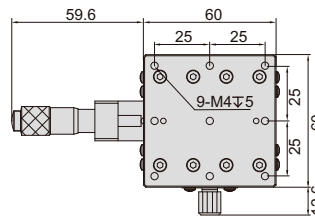

6582-903

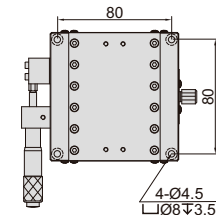
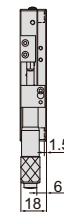
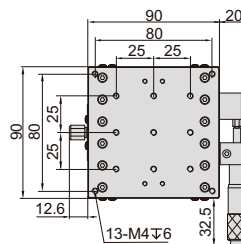

- Cross roller guides, achieve high precision and smooth movement
- Stages made of aluminum alloy

SPECIFICATION (micrometer on the left)

Code	X-axis displacement	Parallelism of top surface to bottom	Micrometer graduation	Micrometer accuracy	Maximum load	Micrometer location	Stage size	Weight
6582-401	±6.5mm	0.02mm	0.01mm	0.01mm	29.4N (3kgf)	left	40x40mm	0.14kg
6582-601	±6.5mm	0.03mm	0.01mm	0.01mm	49N (5kgf)	left	60x60mm	0.24kg
6582-901	±12.5mm	0.03mm	0.01mm	0.02mm	93.1N (9.5kgf)	left	90x90mm	0.47kg
6582-1251	±12.5mm	0.04mm	0.01mm	0.02mm	180N (18.4kgf)	left	125x125mm	1.40kg

SPECIFICATION (micrometer in the middle)

Code	X-axis displacement	Parallelism of top surface to bottom	Micrometer graduation	Micrometer accuracy	Maximum load	Micrometer location	Stage size	Weight
6582-402	±6.5mm	0.02mm	0.01mm	0.01mm	29.4N (3kgf)	middle	40x40mm	0.14kg
6582-602	±6.5mm	0.03mm	0.01mm	0.01mm	49N (5kgf)	middle	60x60mm	0.24kg
6582-902	±12.5mm	0.03mm	0.01mm	0.02mm	93.1N (9.5kgf)	middle	90x90mm	0.47kg
6582-1252	±12.5mm	0.04mm	0.01mm	0.02mm	180N (18.4kgf)	middle	125x125mm	1.40kg

SPECIFICATION (micrometer on the right)

Code	X-axis displacement	Parallelism of top surface to bottom	Micrometer graduation	Micrometer accuracy	Maximum load	Micrometer location	Stage size	Weight
6582-403	±6.5mm	0.02mm	0.01mm	0.01mm	29.4N (3kgf)	right	40x40mm	0.14kg
6582-603	±6.5mm	0.03mm	0.01mm	0.01mm	49N (5kgf)	right	60x60mm	0.24kg
6582-903	±12.5mm	0.03mm	0.01mm	0.02mm	93.1N (9.5kgf)	right	90x90mm	0.47kg
6582-1253	±12.5mm	0.04mm	0.01mm	0.02mm	180N (18.4kgf)	right	125x125mm	1.40kg

XY-AXIS STAGES

Unit: mm



6584-401

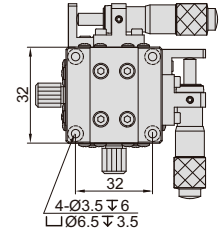
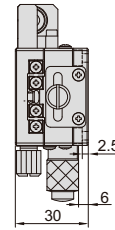
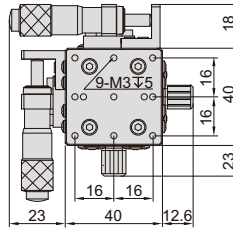

6584-602

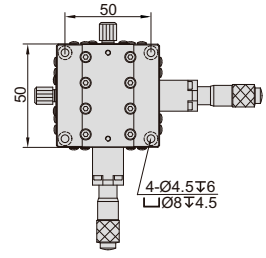
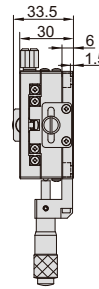
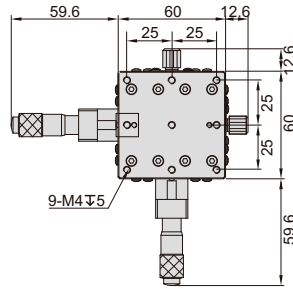

6584-903

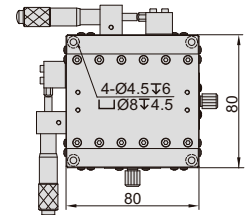
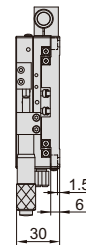
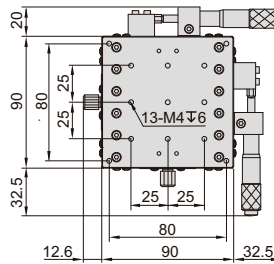

- Cross roller guides, achieve high precision and smooth movement
- Stages made of aluminum alloy

SPECIFICATION (micrometer on the left)

Code	XY-axis displacement	Parallelism of top surface to bottom	Micrometer graduation	Micrometer accuracy	Maximum load	Micrometer location	Stage size	Weight
6584-401	±6.5mm	0.04mm	0.01mm	0.01mm	29.4N (3kgf)	left	40x40mm	0.27kg
6584-601	±6.5mm	0.06mm	0.01mm	0.01mm	49N (5kgf)	left	60x60mm	0.48kg
6584-901	±12.5mm	0.06mm	0.01mm	0.02mm	93.1N (9.5kgf)	left	90x90mm	1kg
6584-1251	±12.5mm	0.08mm	0.01mm	0.02mm	180N (18.4kgf)	left	125x125mm	2.8kg

SPECIFICATION (micrometer in the middle)

Code	XY-axis displacement	Parallelism of top surface to bottom	Micrometer graduation	Micrometer accuracy	Maximum load	Micrometer location	Stage size	Weight
6584-402	±6.5mm	0.04mm	0.01mm	0.01mm	29.4N (3kgf)	middle	40x40mm	0.27kg
6584-602	±6.5mm	0.06mm	0.01mm	0.01mm	49N (5kgf)	middle	60x60mm	0.48kg
6584-902	±12.5mm	0.06mm	0.01mm	0.02mm	93.1N (9.5kgf)	middle	90x90mm	1kg
6584-1252	±12.5mm	0.08mm	0.01mm	0.02mm	180N (18.4kgf)	middle	125x125mm	2.8kg

SPECIFICATION (micrometer on the right)

Code	XY-axis displacement	Parallelism of top surface to bottom	Micrometer graduation	Micrometer accuracy	Maximum load	Micrometer location	Stage size	Weight
6584-403	±6.5mm	0.04mm	0.01mm	0.01mm	29.4N (3kgf)	right	40x40mm	0.27kg
6584-603	±6.5mm	0.06mm	0.01mm	0.01mm	49N (5kgf)	right	60x60mm	0.48kg
6584-903	±12.5mm	0.06mm	0.01mm	0.02mm	93.1N (9.5kgf)	right	90x90mm	1kg
6584-1253	±12.5mm	0.08mm	0.01mm	0.02mm	180N (18.4kgf)	right	125x125mm	2.8kg

XZ-AXIS STAGE CODE 6587-60



- Cross roller guides, achieve high precision and smooth movement
- Stage made of aluminum alloy

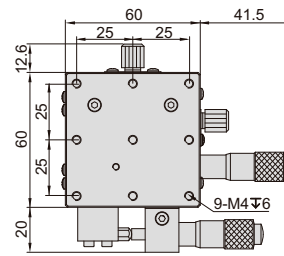

Unit: mm

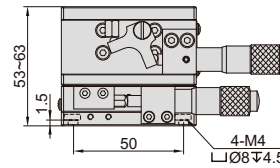
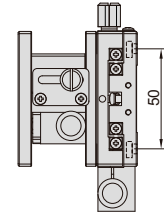

SPECIFICATION

Code	X-axis displacement	Z-axis displacement	Micrometer graduation	Maximum load	Stage size	Weight
6587-60	±6.5mm	10mm	0.01mm	29.4N (3kgf)	60x60mm	0.51kg

12

XYZ-AXIS STAGE CODE 6585-60



- Cross roller guides, achieve high precision and smooth movement
- Stage made of aluminum alloy

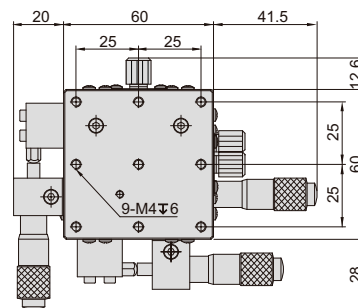

Unit: mm

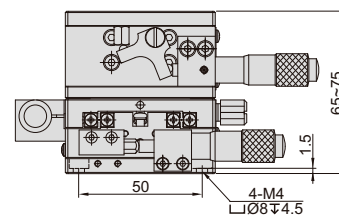
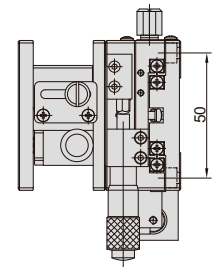

SPECIFICATION

Code	XY-axis displacement	Z-axis displacement	Micrometer graduation	Maximum load	Stage size	Weight
6585-60	±6.5mm	10mm	0.01mm	29.4N (3kgf)	60x60mm	0.75kg

ROTARY STAGES



6583-60H



6583-90

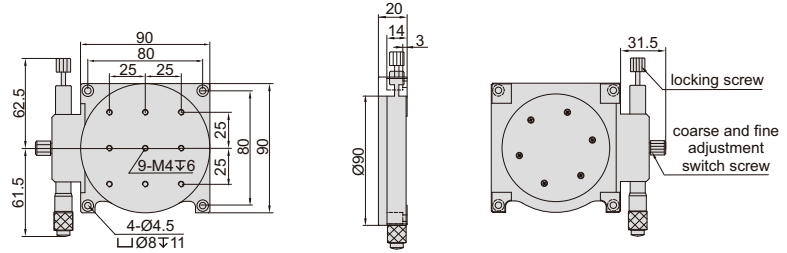
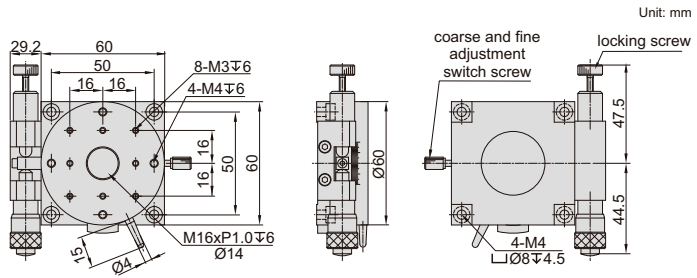

- Precise angle adjustment
- Coarse and fine adjustments
- Stages made of aluminum alloy

12

SPECIFICATION

Code	Range	Parallelism of top surface to bottom	Concentricity	Rotation accuracy	Maximum load	Stage size	Weight
6583-60H	360° coarse, ±5° fine	0.03mm	0.03mm	12'	29.4N (3kgf)	Ø60mm	0.30kg
6583-90	360° coarse, ±5° fine	0.04mm	0.03mm	5'	29.4N (3kgf)	Ø90mm	0.50kg

XY-AXIS ROTARY STAGE CODE 6588-60

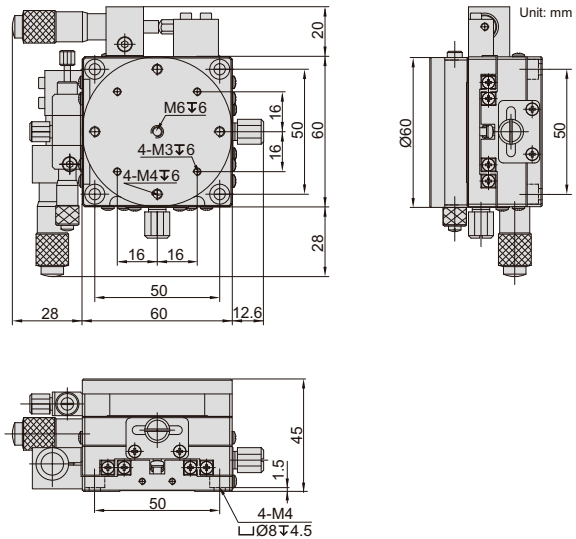

- Cross roller guides, achieve high precision and smooth movement
- Coarse and fine adjustments
- Precise angle adjustment
- Stage made of aluminum alloy

SPECIFICATION

Code	XY-axis displacement	Rotation range	Micrometer graduation	Rotation accuracy	Maximum load	Stage size	Weight
6588-60	±6.5mm	360° coarse, ±5° fine	0.01mm	10'	29.4N (3kgf)	60x60mm	0.64kg

CENTERING INDICATOR

ATTENTION: SCALE DOES NOT INDICATE ANY VALUE



2385-3

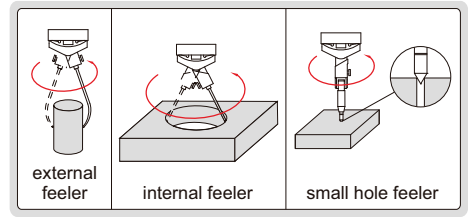
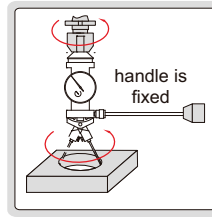

- Provides quick and accurate centering in boring and milling set-up

Code
2385-3



Feeler	Measuring diameter	Accuracy
P1	Ø0-60mm	0.015mm
P2	Ø0-160mm	0.02mm
P3	Ø0-250mm	0.03mm
P4	Ø3.2-80mm	0.015mm
P5	Ø3.2-180mm	0.02mm
P6	Ø3.2-280mm	0.03mm
P7	Ø0-2.8mm	0.015mm

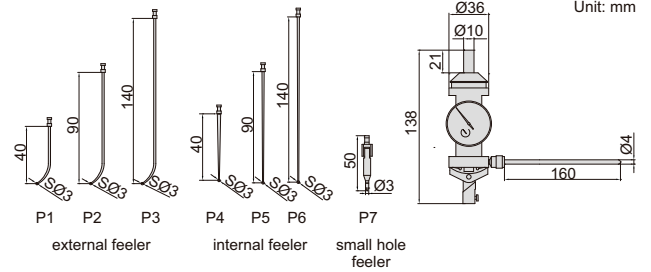

DIAL TEST INDICATOR CENTERING HOLDER

- Center cylinders or holes on machine tools
- Can be used with dial test indicators

Code
6295-1A



6295-1A

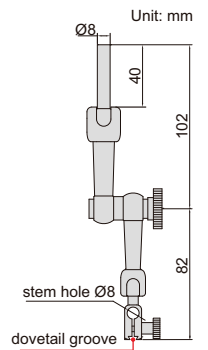

INDICATOR CENTERING HOLDER

- Center cylinders or holes on machine tools
- Can be used with dial test indicators or dial indicators

Code
6294-1A



6294-1A

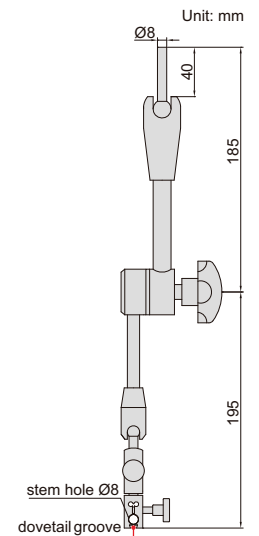

3D ELECTRONIC EDGE FINDERS

INSIZE PLUS
MADE IN GERMANY

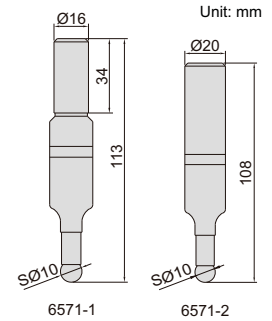
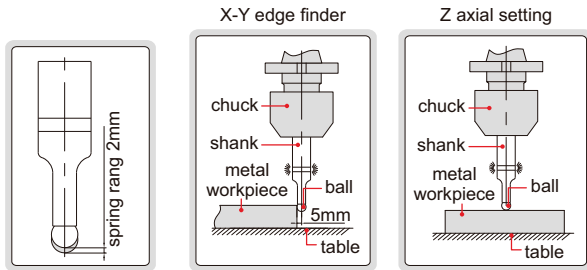

Code	Shank	Contact ball	Accuracy	Battery
6571-1	Ø16mm	SØ10mm	10µm	A23S, 12Vx1 pc
6571-2	Ø20mm	SØ10mm	10µm	A23S, 12Vx1 pc

- The shank is electrically conducted to the metal workpiece through the chuck and table. The LED lights up, when the ball touches the workpiece
- Not suitable for rotary use
- Hardened contact ball

LARGE SHANK DIAMETER ELECTRONIC EDGE FINDERS

12

- The shank is electrically conducted to the metal workpiece through the chuck and table. The LED lights up and the beeper sounds (only for 6572-2), when the ball touches the workpiece
- Not suitable for rotary use
- Hardened shank and contact ball

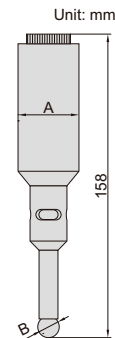
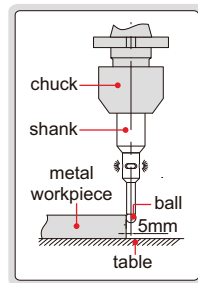

Code	Shank (A)	Contact ball (B)	Accuracy	Beeper	Battery
6572-1	Ø32mm	SØ10mm	5µm	without	23A, 12Vx1 pc
6572-2	Ø32mm	SØ10mm	5µm	with	23A, 12Vx1 pc

ELECTRONIC EDGE FINDERS

- The shank is electrically conducted to the metal workpiece through the chuck and table. The LED lights up and the beeper sounds (only for 6566-3), when the ball touches the workpiece
- Not suitable for rotary use
- Hardened shank and contact ball

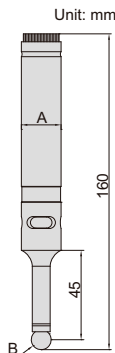
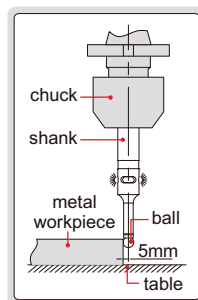

Code	Shank (A)	Contact ball (B)	Accuracy	Beeper	Battery
6566-2	Ø20mm	SØ10mm	5µm	without	23AE, 12Vx1 pc
6566-3	Ø20mm	SØ10mm	5µm	with	23AE, 12Vx1 pc

NON-MAGNETIC EDGE FINDERS

- TiAIN coating, non-magnetic, hardness HV2500, extremely wear resistance
- Suitable for machine speed 400~600rpm

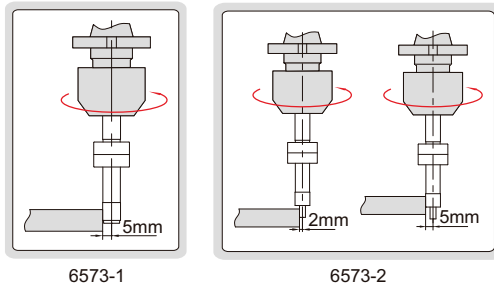

6573-1

6573-2

Code	Shank (A)	Contact point (B)	Contact point (C)	Accuracy
6573-1	Ø10mm	Ø10mm	—	5µm
6573-2	Ø10mm	Ø10mm	Ø4mm	5µm



6573-1

6573-2

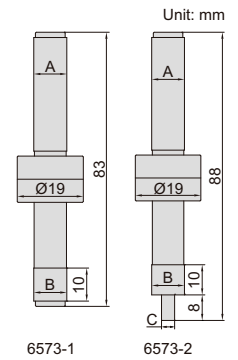

6573-1

6573-2

- Hardened shank and contact point
- Suitable for machine speed 400~600rpm

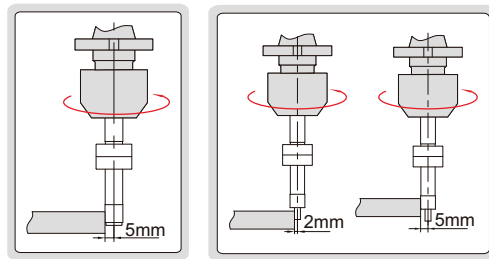

6562-3

6562-4

Code	Shank (A)	Contact point (B)	Contact point (C)	Accuracy
6562-3	Ø10mm	Ø10mm	—	5µm
6562-4	Ø10mm	Ø10mm	Ø4mm	5µm



6562-3

6562-4

EDGE FINDERS

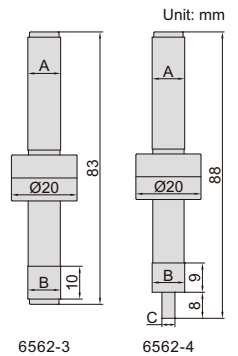

6562-3

6562-4

- Hardened shank and contact point
- Suitable for machine speed 400~600rpm

Code	Shank (A)	Contact point (B)	Accuracy
6567-1	Ø10mm	Ø6mm	8µm

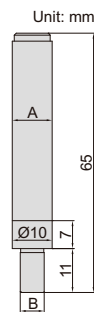

6567-1

EDGE FINDER

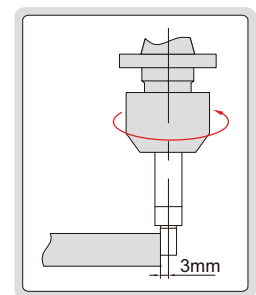

- Ceramic contact point, non magnetic
- Suitable for machine speed 400~600rpm

Code	Shank (A)	Contact point (B)	Accuracy
6568-1	Ø10mm	Ø10mm	8µm

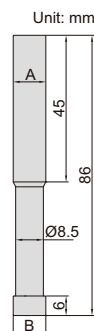

6568-1

CERAMIC EDGE FINDER

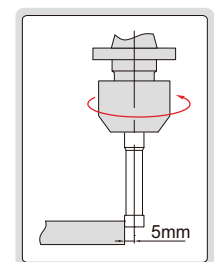

ELECTRONIC ZERO SETTER

INSIZE PLUS
MADE IN GERMANY

LOW TEST FORCE

- The base is electrically conducted to the cutting tools through the table and chuck. The LED lights up when the cutting tool touches the anvil
- Magnetic base
- Two batteries LR44

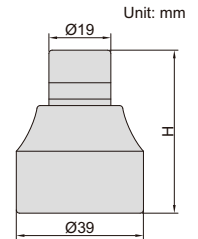
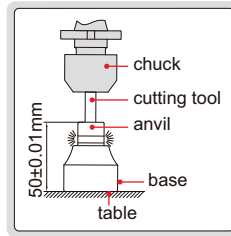
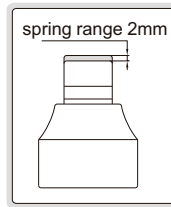

6553-50

Code	Height (H)	Accuracy	Test force
6553-50	50mm	±10µm	7N (at 49mm)

ELECTRONIC ZERO SETTER

ATTENTION:
HIGH TEST FORCE

- The base is electrically conducted to the cutting tools through the table and chuck. The LED lights up when the cutting tool touches the anvil
- Magnetic base
- Battery LR44

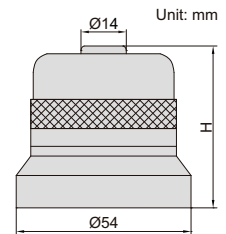
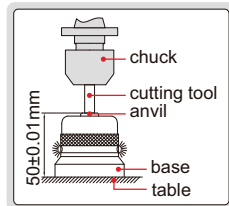

6550-50A

Code	Height (H)	Accuracy	Test force
6550-50A	50mm	±10µm	27N (at 49mm)

ZERO SETTER

INSIZE PLUS
MADE IN GERMANY

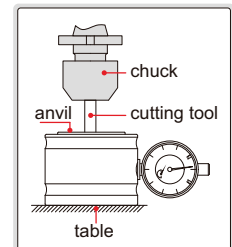
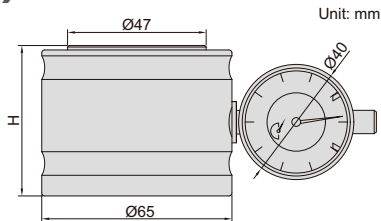

6554-50

Code	Height (H)	Accuracy	Test force
6554-50	50mm	±10µm	9N (at 50mm)

ZERO SETTER

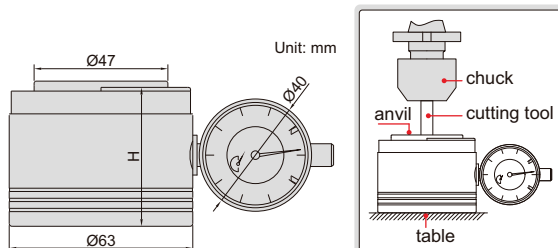

6556-50

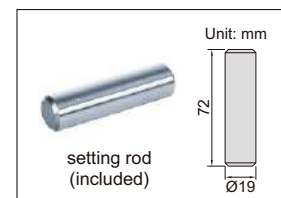

Code	Height (H)	Accuracy	Test force
6556-50	50mm	±10µm	10N (at 50mm)

ZERO SETTER

- Magnetic base

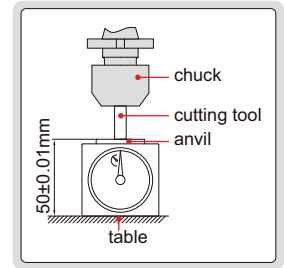
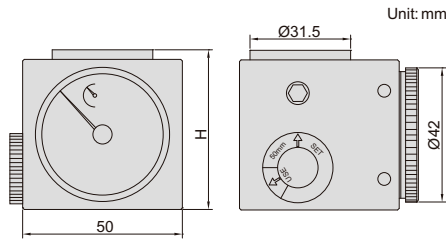

2397-502A

Code	Height (H)	Accuracy	Test force
2397-502A	50mm	±10µm	9N (at 50mm)

ZERO SETTER

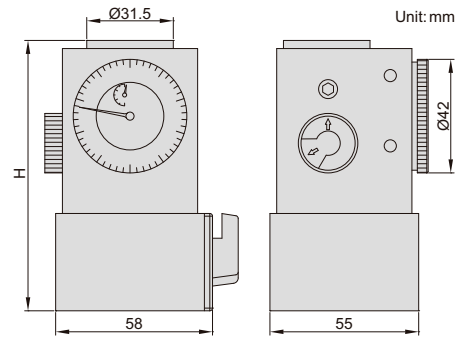
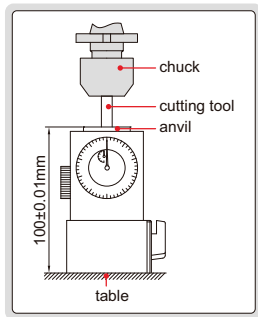

2394-100A

- Magnetic base with on-off switch

Code	Height (H)	Accuracy	Test force
2394-100A	100mm	±10µm	9N (at 100mm)

LOW TEST FORCE

LOW TEST FORCE ZERO SETTER

INSIZE PLUS
MADE IN GERMANY

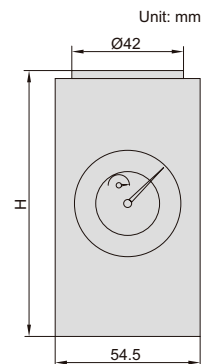
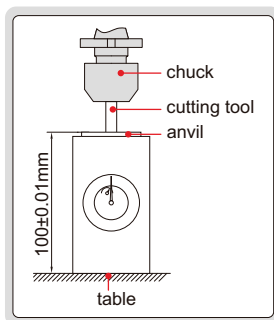

6555-100B

- Magnetic base
- Low test force, suitable for micro tools with minimum diameter Ø0.1mm

Code	Height (H)	Accuracy	Test force
6555-100B	100mm	±10µm	1N (at 100mm)

DIGITAL HORIZONTAL SCALES

DATA OUTPUT



7101-300A



7101-400A

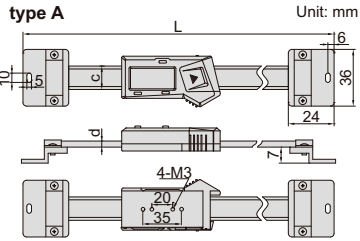

- Resolution: 0.01mm/0.0005"
- Buttons: on/off, zero, mm/inch
- Automatic power off, move the digital unit to turn on power
- Battery CR2032
- Data output
- Made of stainless steel
- Supplied with bracket to be mounted on the back
- Optional accessory: data output cable (code 7315-, 7302-, 7305-)

example of application

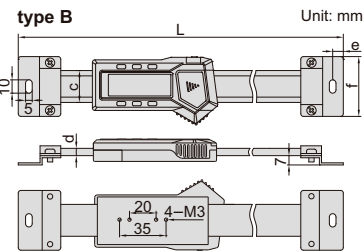
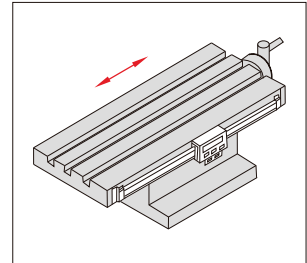

- Resolution: 0.01mm/0.0005"
- Button function: on/off, zero, mm/inch, ABS, data preset
- Battery CR2032, data output
- Made of stainless steel
- Supplied with bracket to be mounted on the back
- Optional accessory: data output cable (code 7315-, 7302-, 7305-)

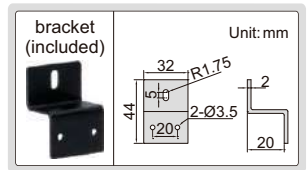

Code	Range	Type	Accuracy	L	c	d
7101-100A	100mm	A	±0.02mm	215	16	4
7101-150A	150mm	A	±0.03mm	265	16	4
7101-200A	200mm	A	±0.03mm	315	16	4
7101-300A	300mm	A	±0.04mm	445	16	4

Code	Range	Type	Accuracy	L	c	d	e	f
7101-400A	400mm	B	±0.05mm	590	24	5.5	8	45
7101-500A	500mm	B	±0.05mm	690	24	5.5	8	45
7101-600A	600mm	B	±0.08mm	790	24	5.5	8	45
7101-800A	800mm	B	±0.10mm	990	24	5.5	8	45
7101-1000A	1000mm	B	±0.10mm	1190	31	10.5	10	60

13

DIGITAL VERTICAL SCALES

DATA OUTPUT

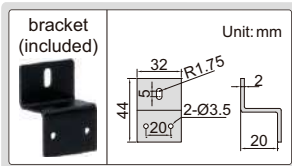

example of application

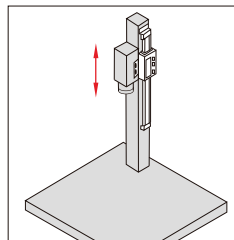

data output cable



- Resolution: 0.01mm/0.0005"
- Buttons: on/off, zero, mm/inch, ABS/INC, data hold, TOL, set
- Battery LR44, data output
- Made of stainless steel
- Supplied with bracket to be mounted on the back
- Optional accessory: data output cable (code 7302-SPC7, keyboard format)

Code	Range	Accuracy	B	C	D	E	F	L
7102-100	100mm/4"	±0.02mm	4	20	6	24	40	245
7102-150	150mm/6"	±0.03mm	4	20	6	24	40	296
7102-200	200mm/8"	±0.03mm	4	20	6	24	40	345
7102-300	300mm/12"	±0.04mm	4	20	6	24	40	445
7102-400	400mm/16"	±0.05mm	4	20	6	24	40	545
7102-500	500mm/20"	±0.05mm	5.5	24	8	32	45	685
7102-600	600mm/24"	±0.08mm	5.5	24	8	32	45	785
7102-800	800mm/32"	±0.10mm	5.5	24	8	32	45	985
7102-1000	1000mm/40"	±0.10mm	10.5	31	25	40	60	1245



7102-300

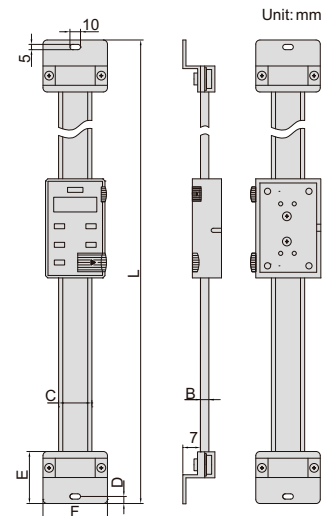

LINEAR SCALES



ISL-A1-300

Series ISL-A1 and ISL-A5

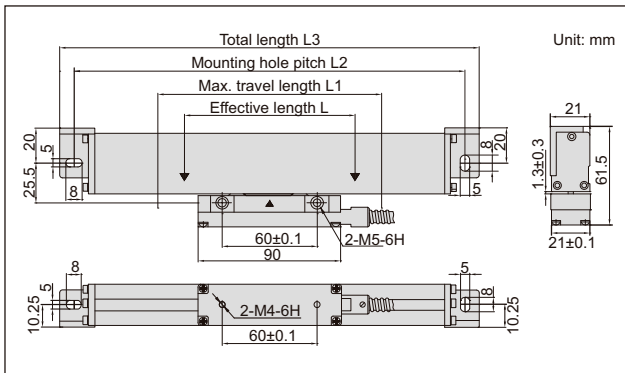

Series ISL-B5

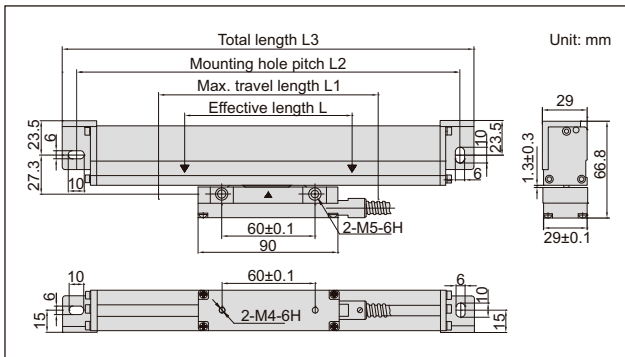

STANDARD DELIVERY

Main unit	1 pc
'L' shape support	1 pc
Anti-dust cover	1 pc
Plain base	1 pc (for L≥1500mm)
Mounting accessories	1 package

Effective length (L)	Code		
	Series ISL-A1	Series ISL-A5	Series ISL-B5
50mm	ISL-A1-50	ISL-A5-50	ISL-B5-50
100mm	ISL-A1-100	ISL-A5-100	ISL-B5-100
150mm	ISL-A1-150	ISL-A5-150	ISL-B5-150
200mm	ISL-A1-200	ISL-A5-200	ISL-B5-200
250mm	ISL-A1-250	ISL-A5-250	ISL-B5-250
300mm	ISL-A1-300	ISL-A5-300	ISL-B5-300
350mm	ISL-A1-350	ISL-A5-350	ISL-B5-350
400mm	ISL-A1-400	ISL-A5-400	ISL-B5-400
450mm	ISL-A1-450	ISL-A5-450	ISL-B5-450
500mm	ISL-A1-500	ISL-A5-500	ISL-B5-500
550mm	ISL-A1-550	ISL-A5-550	ISL-B5-550
600mm	ISL-A1-600	ISL-A5-600	ISL-B5-600
650mm	ISL-A1-650	ISL-A5-650	ISL-B5-650
700mm	ISL-A1-700	ISL-A5-700	ISL-B5-700
750mm	ISL-A1-750	ISL-A5-750	ISL-B5-750
800mm	ISL-A1-800	ISL-A5-800	ISL-B5-800
850mm	ISL-A1-850	ISL-A5-850	ISL-B5-850
900mm	ISL-A1-900	ISL-A5-900	ISL-B5-900
950mm	ISL-A1-950	ISL-A5-950	ISL-B5-950
1000mm	ISL-A1-1000	ISL-A5-1000	ISL-B5-1000
1100mm		ISL-A5-1100	ISL-B5-1100
1200mm			ISL-B5-1200
1300mm			ISL-B5-1300
1400mm			ISL-B5-1400
1500mm			ISL-B5-1500
1600mm			ISL-B5-1600
1700mm			ISL-B5-1700
1800mm			ISL-B5-1800
1900mm			ISL-B5-1900
2000mm			ISL-B5-2000
2100mm			ISL-B5-2100
2200mm			ISL-B5-2200
2300mm			ISL-B5-2300
2400mm			ISL-B5-2400
2500mm			ISL-B5-2500
2600mm			ISL-B5-2600
2700mm			ISL-B5-2700
2800mm			ISL-B5-2800
2900mm			ISL-B5-2900
3000mm			ISL-B5-3000
3100mm			ISL-B5-3100
3200mm			ISL-B5-3200

To be continued

Continued from previous page

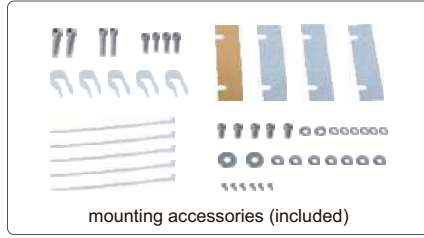
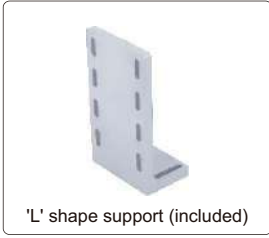

SPECIFICATION

Code	Series ISL-A1		Series ISL-A5		Series ISL-B5	
L1 (mm)	L+30(L<950)	L+50(L≥950)	L+30(L<950)	L+50(L≥950)	L+30(L<950)	L+50(L≥950)
L2 (mm)	L+132(L<950)	L+152(L≥950)	L+132(L<950)	L+152(L≥950)	L+136(L<950)	L+156(L≥950)
L3 (mm)	L+149(L<950)	L+169(L≥950)	L+149(L<950)	L+169(L≥950)	L+154(L<950)	L+174(L≥950)
Resolution	1μm		5μm		5μm	
Max. response speed	50m/min		90m/min		60m/min	
Scale grating pitch	20μm					
Scale reference point pitch	50mm					
Accuracy	±(5+5L/1000)μm L is the effective length in mm					
Cable length	3.5m (L: 50-950mm), 5m (L: 1000-1500mm), 10m (L: 1600-3200mm)					

COUNTERS

13

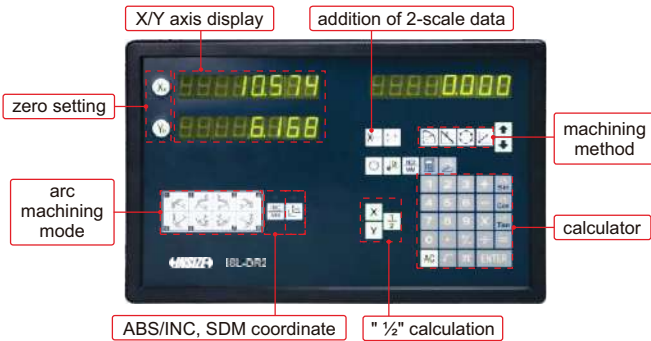

ISL-DR2

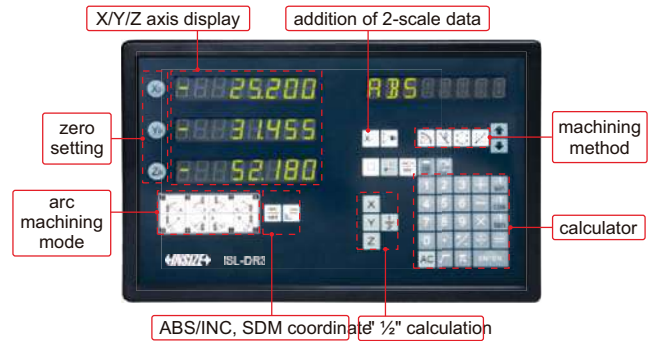

ISL-DR3



SPECIFICATION

Code	ISL-DR2	ISL-DR3
Application	two-axis	three-axis
Scale input ports	2	3
Resolution	0.05μm, 0.1μm, 0.2μm, 0.5μm, 1μm, 2μm, 5μm, 10μm, 20μm, 50μm	
Functions	addition of 2-scale data, linearity error compensation, smoothing, RS232C interface unit, BCD code out, zero setting, preset, resolution setting, counting direction setting, inch/mm conversion, ABS/INC conversion, expansion/contraction coefficient setting, "1/2" calculation, detecting R1, bolt-hole circle machining, ramp circle machining	
Power supply	110/220V, 50/60Hz	
Dimension	295×185×45mm	
Weight	1.45kg	

STANDARD DELIVERY

Main unit	1 pc
Mounting bracket	1 pc
Ground cable	1 pc
RS232C cable	1 pc
Software CD for RS232C	1 pc



software CD (included)



LINEAR GAGE
IP65
WATERPROOF

LINEAR GAGES AND DISPLAY UNIT



linear gage



display unit
7106-1

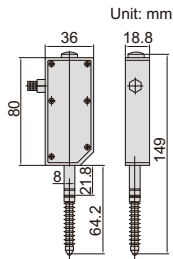
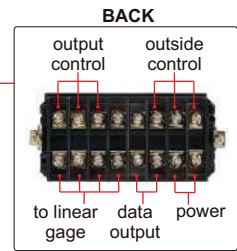

Unit: mm

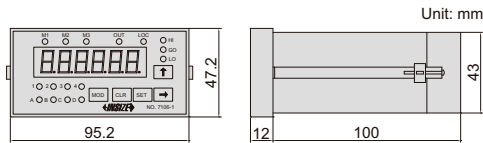

Unit: mm

- Linear gage: shock-proof, water proof, dust proof, suitable for high speed movement, long working life
- Display unit: set tolerance and make judgment (out of upper tolerance, within tolerance, out of lower tolerance), output the judgment to control outside devices, set zero and hold reading from outside



LINEAR GAGE SPECIFICATION

Code	7106-11	7106-12
Measuring range	12mm/0.47"	12mm/0.47"
Resolution	0.01mm/0.0004"	0.001mm/0.00004"
Accuracy	20μm	5μm
Hysteresis	10μm	2μm
Measuring principle	capacity system	
Voltage	5V	
Sampling frequency	100 times/sec.	
Working life	ten million times	
Dust/waterproof	IP65	
Measuring force	1.5N	
Cable length	2m	
Data output	four-core wire	

DISPLAY UNIT SPECIFICATION

Code	7106-1
Display	6 digits
Quantity of linear gages to be connected	1 pc
Tolerance	set tolerance and make judgment with alarm and lights (out of upper tolerance, within tolerance, out of lower tolerance)
Output control	output the tolerance judgment (out of upper tolerance, within tolerance, out of lower tolerance) to control outside devices
Outside control	control the display units from outside (set zero, hold reading)
Data output	connect to PC
Power supply	DC 9~24V

MULTI LINEAR GAGE SYSTEM

LINEAR GAGE
IP65
WATERPROOF



linear gage

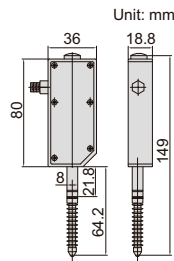

4-channel interface box
7107-1

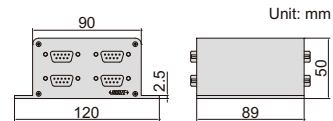

software CD
(included)

application

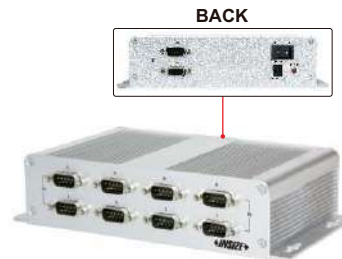

8-channel interface box
7107-2

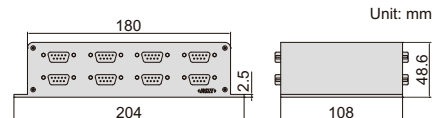

- Interface boxes are supplied with software. In the software, it is possible to set tolerance of each channel and show judgment (red when out of tolerance, green when within tolerance), set zero, collect data manually or automatically (time is adjustable), output data to Excel, print report.
- Connection box (code: 7107-3) is needed to connect interface boxes, when two or more interface boxes are used. Maximum 4 interface boxes can be connected.

LINEAR GAGE SPECIFICATION

Code	7107-11	7107-12
Measuring range	12mm/0.47"	12mm/0.47"
Resolution	0.01mm/0.0004"	0.001mm/0.00004"
Accuracy	20μm	5μm
Hysteresis	10μm	2μm
Measuring principle	capacity system	
Voltage	5V	
Sampling frequency	100 times/sec.	
Working life	ten million times	
Dust/waterproof	IP65	
Measuring force	1.5N	
Cable length	2m	
Data output	RS232	

INTERFACE BOX SPECIFICATION

Code	7107-1	7107-2
Quantity of linear gages to be connected	4 pcs	8 pcs
Data output	RS232 and RS485	
Power supply	DC 9~24V	

CONNECTION BOX (OPTIONAL) SPECIFICATION

Code	7107-3
Quantity of interface boxes to be connected	4 pcs
Data output	RS232 and RS485
Power supply	DC 9~24V



CABLE OF DIGITAL INDICATOR AND DISPLAY UNIT



cable of digital indicator
7309-B01M

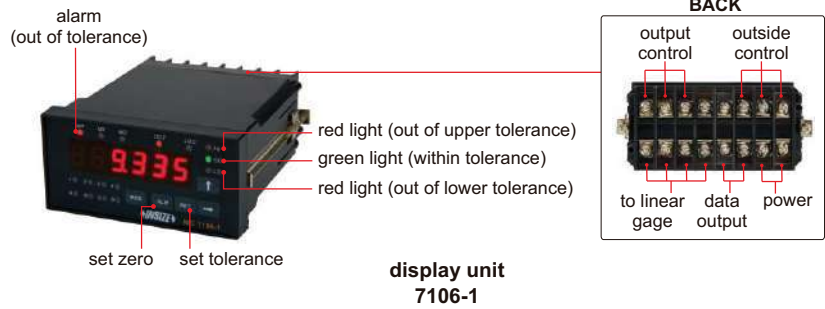

display unit
7106-1

application

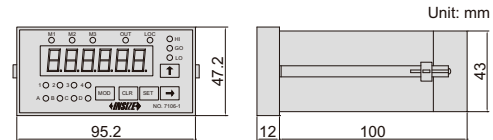

- Display unit: set tolerance and make judgment (out of upper tolerance, within tolerance, out of lower tolerance), output the judgment to control outside devices, set zero and hold reading from outside, data preset, measuring direction change

CABLE SPECIFICATION

Code	Description	Plug type to product	Socket type on product	Applicable product
7309-B01M	cable of digital indicator (length 2.5m)			digital indicators

DISPLAY UNIT SPECIFICATION

Code	7106-1
Display	6 digits
Quantity of digital indicator to be connected	1 pc
Tolerance	set tolerance and make judgment with alarm and lights (out of upper tolerance, within tolerance, out of lower tolerance)
Output control	output the tolerance judgment (out of upper tolerance, within tolerance, out of lower tolerance) to control outside devices
Outside control	control the display units from outside (set zero, hold reading)
Data output	connect to PC
Power supply	DC 9~24V

CABLE OF DIGITAL INDICATOR AND MULTI CHANNEL INTERFACE BOX

application

out of lower tolerance (red)

out of upper tolerance (red)

within tolerance (green)

within tolerance (green)

real time reading

set zero

collect data



software CD (included)



cable of digital indicator
7309-C01M

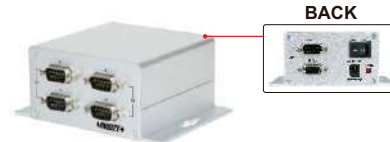

4-channel interface box
7107-1

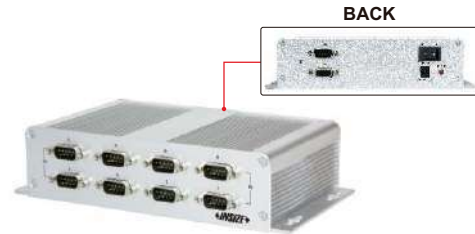
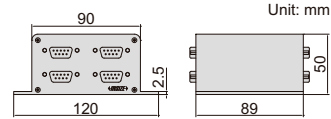

8-channel interface box
7107-2

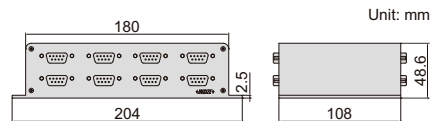

- Interface boxes are supplied with software. In the software, it is possible to set tolerance of each channel and show judgment (red when out of tolerance, green when within tolerance), set zero, collect data manually or automatically (time is adjustable), output data to Excel, print report.
- Connection box (code: **7107-3**) is needed to connect interface boxes, when two or more interface boxes are used. Maximum 4 interface boxes can be connected.

CABLE SPECIFICATION

Code	Description	Plug type to product	Socket type on product	Applicable product
7309-C01M	cable of digital indicator (length 2 m)			 digital indicators

INTERFACE BOX SPECIFICATION

Code	7107-1	7107-2
Quantity of digital indicators to be connected	4 pcs	8 pcs
Data output	RS232 and RS485	
Power supply	DC 9~24V	

CONNECTION BOX (OPTIONAL) SPECIFICATION

Code	7107-3
Quantity of interface boxes to be connected	4 pcs
Data output	RS232 and RS485
Power supply	DC 9~24V

MINI CNC CMM (SHOP FLOOR TYPE) CODE CMM-MN432

- Can be used in shop floor, with the following features:
- Suitable for wide temperature range
 - Water and oil resistance
 - Compact design, small size
 - Three sides open, easy to load and unload workpieces
 - Without compress air
 - Easy installation

ATTENTION: MEASUREMENT ON THE LEFT SIDE OF WORKPIECES IS LIMITED

ATTENTION: ROTATION OF PORBE HEAD IS MANUAL



CMM-MN432

FEATURES

- Integrated control system, safe, reliable and easy to operate
- High precision linear guide rail and ball screw for three axes

NET-DMIS SOFTWARE

- Can measure point, straight line, curve, circle, ellipse, plane, groove, cylinder, sphere, cone, ring, edge point, corner point, polygon, straightness, flatness, circularity, cylindricity, profile of a line, profile of a surface, perpendicularity, parallelism, angularity, coaxiality, concentricity, symmetry, position, composite position, circular runout and total runout
- Modular software structure, can support: temperature compensation, turning table, I/O interface
- Can program in offline mode and do virtual measurement based on CAD model, can extract the element features of CAD for programming
- Support dynamic point measurement and import DMO theoretical point coordinates for vector point measurement
- Can import and convert CAD model (SAT, IGES, STEP, STL)
- Can select multi language, metric and inch, polar and straight coordinate system
- Have multiple export ways: export measured data (SAT, IGES, STEP), report windows (PDF, HTML, MHT, RTF, EXCEL, CSV, txt, images, WORD, etc.), custom EXCEL template
- Support uploading the measuring result to server

CONTROL SYSTEM

- Double computer control systems
- Driven by DC servo motor
- The control system supports communication with machine tools
- The control system has 12 buttons for customize

SPECIFICATION

Code	CMM-MN432 ***
Measuring range (X×Y×Z)	400×200×300mm
Resolution	0.1μm
Repeatability	1μm
Accuracy (L is measuring range in mm)	±(4.5+L/200)μm (15°C~30°C) ±(5.5+L/200)μm (10°C~40°C)
Probe error	±5μm
Temperature	10°C~40°C
Humidity	40~60%
Power	220V±10%, 50Hz ***
Max. load	50kg
Dimension (L×W×H)	1270×1110×1630mm
Weight	280kg

*** Add "-U" on code NO. when power supply is 110V, 50/60Hz

STANDARD DELIVERY

Main unit		1 pc
Probe system	Probe head *	1 pc
	Probe *	1 pc
	Styli **	1 set
Calibration system	Datum sphere (Ø25mm)	1 pc
	Pivot pillar	1 pc
Computer system	Computer	1 pc
	Printer	1 pc
Software		1 pc

* The probe head and probe are Renishaw brand

** The styli system include styli, stylus centers and extensions

To be continued

Continued from previous page

PROBE (included) SPECIFICATION

Probe head	Angular movement with horizontal axis	0°~90° in 15 steps
	Angular movement with vertical axis	±180° in 15 steps
	Control mode	manual
	Number of positions	168
	Probe mounting	M8
Probe	Weight	210g
	Detect direction	±X, ±Y, +Z
	Styli mounting	M2
	Rating life	>1000,000 times
	Weight	22g

EXTENSION (included) SPECIFICATION

Code	Material	Stem diameter	Length	Quantity
SE7	stainless steel	Ø3mm	5mm	1 pc
SE4			10mm	1 pc
SE5			20mm	1 pc
SE6			30mm	1 pc

STYLUS CENTER (included) SPECIFICATION

Code	Material	Center size	Effective working length	Quantity
SC2	stainless steel	7mm	7.5mm	1 pc

STYLUS (included) SPECIFICATION

Code	Material	Ball diameter	Length	Stem diameter	Effective working length	Quantity
PS23R	ruby ball / titanium stem	SØ1mm	20mm	Ø0.7mm	7mm	1 pc
PS2R		SØ2mm		Ø1.4mm	14mm	1 pc
PS16R	SØ3mm	Ø1.5mm		17.5mm	1 pc	
PS17R	ruby ball / stainless steel stem	SØ4mm	10mm	Ø1.5mm	20mm	1 pc
PS8R		SØ2mm		Ø1mm	6mm	4 pcs
PS1R		SØ3mm	Ø1.5mm	7.5mm	1 pc	

106 PCS JIG SET FOR CMM CODE ISY-100

14







ISY-100

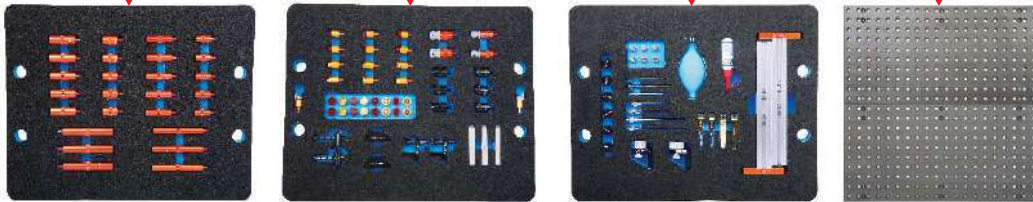

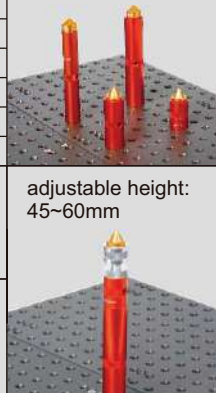
VIDEO



















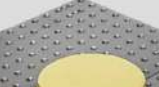

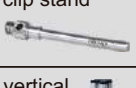

Product	Code	Size (mm)	Quantity	Application
stand 	ISY-100-1001	Ø16×30	5	
	ISY-100-1002	Ø16×50	5	
	ISY-100-1003	Ø16×100	3	
stand 	ISY-100-1004	Ø20×30	5	
	ISY-100-1005	Ø20×50	5	
	ISY-100-1006	Ø20×100	3	
stand with fine adjustment 	ISY-100-2001	Ø16×45~60	2	adjustable height: 45~60mm
stand with fine adjustment 	ISY-100-2003	Ø20×45~60	2	



















application examples



To be continued

Continued from previous page

Product	Code	Size (mm)	Quantity	Application
horizontal spring stand 	ISY-100-4001	—	2	
horizontal screw stand 	ISY-100-5001	—	2	
magnetic stand (magnetic top surface) 	ISY-100-7001	Ø20×25	3	
stand for slice parts 	ISY-100-8001	Ø20×25	2	ISY-100-8001 and ISY-100-8002 are used together 
clamping stand for slice parts 	ISY-100-8002		1	
clip 	ISY-100-1201	—	2	
clip 	ISY-100-1301	—	2	
clip stand 	ISY-100-1401	Ø6×60	2	
	ISY-100-1402	Ø6×100	2	
vertical square column 	ISY-100-3003	30×30×250	2	
sliding support plate 	ISY-100-1801	78×20×10	3	
clamping screw 	ISY-100-2301	Ø8×20	6	
screw 	ISY-100-2302	Ø8×20	6	
base plate 	ISY-600-400200	400×400×12	2 pcs /per set	—

Product	Code	Quantity	Application
wrench 	ISY-100-3701	1	—
wrench 	ISY-100-3801	1	—
	ISY-100-3802	1	—
	ISY-100-3803	1	—
45° stand 	ISY-100-9001	2	
V shape support 	ISY-100-1901	2	
V shape support 	ISY-100-1902	2	
support head 	 ISY-100-2701	4*	
	 ISY-100-2702	4*	
	 ISY-100-2703	4*	
	 ISY-100-2704	4*	
	 ISY-100-2705	4*	
	 ISY-100-2706	4*	
	 ISY-100-2707	4*	
		4*	
dust cleaner 	ISY-100-3501	1	—
lubricating oil 	ISY-100-3601	1	—

*2 pcs in aluminum, 2 pcs in plastic

SURFACE PROFILE MEASURING MACHINE

CODE SPM-1000

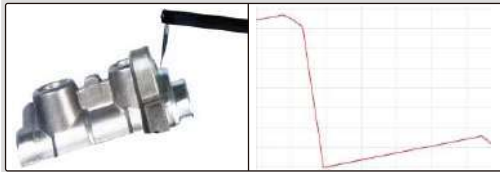

- Software is included, for surface profile measurement and data output
- Probe compensation
- Output as format txt, csv, etc.
- Large range design, the leverage ratio is 1:2.2, maintain the original accuracy of the sensor
- The overall structure of the Z-axis sensor does not have any elastic components, ensuring the measuring force is constant regardless the position of probe

14



standard blocks (included)



standard balls (included)



standard shaft (included)



calibration



contour scanning

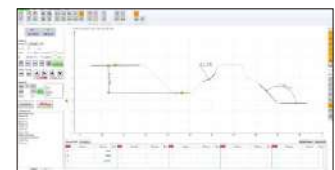

dimension measurement

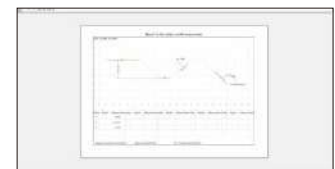

data output

SPECIFICATION

X axis measuring range	140mm
X axis resolution	0.2 μ m
X axis straightness	0.8 μ m/100mm
X axis traverse speed	0.1~10mm/s
Z axis measuring range	\pm 20mm
Z axis resolution	0.05 μ m
Z axis traverse speed	0.5~10mm/s
Linear accuracy	$\pm(1.5+ 0.2H)\mu$ m, H is measuring height in mm
Angular measuring accuracy	$\pm 2'$
Arc measuring accuracy	$\pm(2+R/8)\mu$ m, R is 2~10mm standard ball
Radius of probe tip	25 μ m
Traverse direction	backward
Measuring force	6.86~9.8mN
Measuring unit	mm/inch
Traceable angle	72° (upward), 87° (downward)
Drive mode	motor
Travel of Z axis	430mm
Dimension (L×W×H)	1200×700×1780mm
Power supply	220 \pm 5%V, 50Hz
Weight	320kg

To be continued

Continued from previous page

STANDARD DELIVERY

Main unit	1 pc
Standard probe and arm	1 pc of each
Standard block	2 pcs
Standard ball	2 pcs
Standard shaft	1 pc
Stage	1 pc
Vise	1 pc
Measuring arm	1 pc
Computer	1 pc
Measurement software	1 pc
Printer	1 pc
Installation tools	1 set

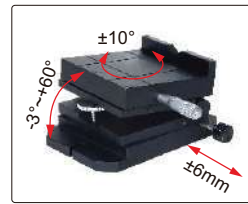

stage (included)



vise (included)

OPTIONAL ACCESSORY

Probe and arm	see details
---------------	-------------

SPECIFICATION OF PROBES AND ARMS

Unit: mm

<p>chisel probes</p> <p>code SPM-1000-T01 (H=32mm, included) code SPM-1000-T02 (H=48mm, optional) code SPM-1000-T03 (H=68mm, optional)</p>	<p>cone probes</p> <p>code SPM-1000-Z01 (H=32mm, optional) code SPM-1000-Z02 (H=48mm, optional) code SPM-1000-Z03 (H=68mm, optional)</p>	<p>ball probes</p> <p>code SPM-1000-R01 (H=32mm, optional) code SPM-1000-R02 (H=48mm, optional) code SPM-1000-R03 (H=68mm, optional)</p>
<p>standard arm, code SPM-1000-SP (included), probe is not included</p>		<p>arm for small holes, code SPM-1000-SBP (optional), probe is included</p> <p>measure the contour of holes with diameter > Ø8mm</p>
<p>transverse arm, code SPM-1000-LP (optional), probe is not included</p> <p>measure the contour of holes in radial direction</p>		

LASER SCAN MICROMETERS



calibration gage (optional)

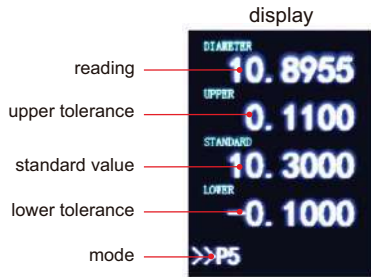

LDM-030



- Measure outer diameter, ellipticity, run-out, maximum diameter of tools, etc.
- Can be used for transparent or non transparent workpieces
- Tolerance measurement
- Online or offline measurement
- Connected with computer and PLC

Unit: mm

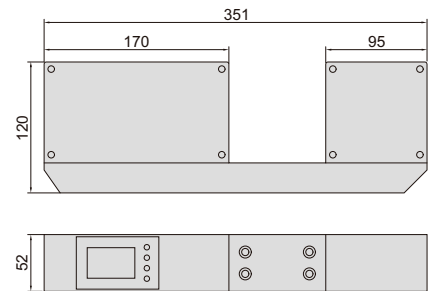

15

SPECIFICATION

Code	LDM-030	LDM-065
Measuring range	0.1~30mm	0.5~65mm
Resolution	0.01/0.1/1/10/100μm selectable	
25°C accuracy	±(0.5+5%D)μm D is measuring diameter in mm	
Repeatability	0.2μm	0.4μm
Laser wave length	650nm	
Measuring speed	800~3200times/s (adjustable)	
Working temperature	0~50°C	
Working humidity	35~85RH without condensation	
Output	dual channel RS485	
Alarm output	24V, 1A	
Power supply	DC24V, 2A	
Dimension (L×W×H)	351×52×120mm	469×52×156mm
Weight	5kg	8kg

STANDARD DELIVERY

Main unit	1 pc
V-block	1 pc
AC/DC adapter	1 pc
RS485 cable	1 pc

OPTIONAL ACCESSORY

Calibration gage	custom made
------------------	-------------

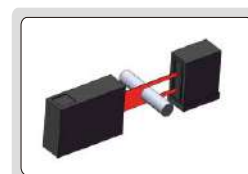

measure outer diameter

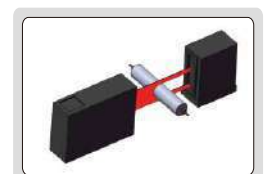

measure ellipticity and run-out

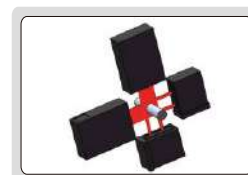

two-axis measurement

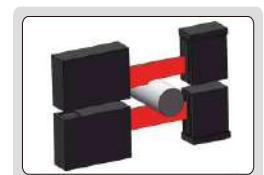

large size measurement

TOOL PRESETTER (PROJECTOR TYPE) CODE TLP-P340**



- 99 data can be saved and printed



standard rod (included)



BT50/BT40 converter (optional)



BT50/BT30 converter (optional)

SPECIFICATION

Maximum tool diameter (X axis)		Ø300mm
Height measuring range (Z axis)		30~400mm
Accuracy	X axis	±6µm
	Z axis	±13µm
Resolution		0.5µm
Diameter of projection screen		Ø120mm
Lens	magnification	20X
	view filed	Ø6mm
Illumination		24V/20W
Spindle holder		BT50
Power supply		220V, 50/60HZ **
Dimension (L×W×H)		940×520×870mm
Weight		90kg

** Add "-U" on code NO. when power supply is 110V, 50/60Hz

STANDARD DELIVERY

Main unit	1 pc
BT50 spindle holder	1 pc
Standard rod	1 pc
Foot-switch	1 pc
Anti-dust cover	1 pc

OPTIONAL ACCESSORY

BT50/BT30 converter	TLP-P340-C1
BT50/BT40 converter	TLP-P340-C2

PROFILE PROJECTORS

Screen diameter: 300mm

X-Y travel: 150x50mm



ISP-Z3015



ISP-A1000E

digital readout of ISP-A1000E



- touch buttons
- USB data output to Excel and CAD
- show diagram directly

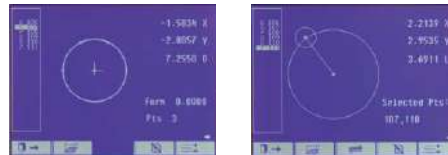

software CD (included, only for ISP-A1000E)

OPTIONAL ACCESSORY



lens

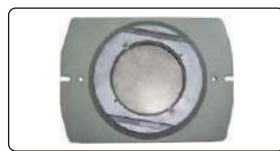

rotary table (glass plate diameter 100mm)



overlay chart (protractor with 1° graduation, radius with 1mm increment)



holder with clamp



swivel center support



V-block with clamp



50mm reading scale (check magnification accuracy)



300mm calibration scale (check magnification accuracy together with 50mm reading scale or calibrate measuring accuracy)

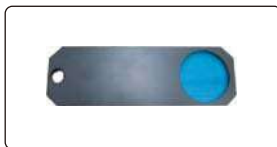

blue filter



demo sample



printer (only for ISP-A1000E)

To be continued



Continued from previous page

SPECIFICATION

Code		ISP-Z3015	ISP-A1000E				
Edge detector		not included		included			
Lens	magnification	10X (included)	20X (optional)	50X (optional)	100X (optional)		
	view field	Ø30mm	Ø15mm	Ø6mm	Ø3mm		
	working distance	77.7mm	44.3mm	38.4mm	25.3mm		
Max. workpiece height		90mm	90mm	90mm	90mm		
Magnification accuracy		±0.08%					
Image		erect image					
Projector screen		diameter: Ø300mm					
		rotation range: 0°~360°, resolution: 1" or 0.01°					
		reference lines: cross-hairs					
Stage	metal stage size	340×152mm					
	glass stage size	196×96mm					
	X-Y stage travel	range: 150×50mm					
		resolution: 0.5µm					
	Z (focus) travel range	90mm					
max. load capacity	4kg						
Illumination		contour illumination: 24V/150W halogen lamp, brightness is adjustable					
		surface illumination: 24V/150W halogen lamp					
Data processing unit	display	X-Y stage travel, screen rotation					
	output	RS232C		RS232C, USB (data output to Excel and CAD)			
	function		measure coordinate of point				measure coordinate of point
			measure coordinate of line				measure coordinate of line
		measure center coordinate, radius of circle with three points				measure center coordinate, radius of circle with three points	
		measure distance between two objects				measure distance between two objects	
		measure angle with four points or two lines				measure angle with four points or two lines	
		set origin of coordinate				coordinate transform	
		coordinate transform				choose measurement object automatically according to the selective point and display the result	
		set midpoint of coordinate					
advanced function	—		programming for batch measurements				
Power supply		110/220V, 50/60Hz					
Dimension (L×W×H)		550×770×1100mm					
Weight		135kg					

STANDARD DELIVERY

Main unit	1 pc
10X lens with half-reflection mirror and oblique illuminator mirror	1 pc
Overlay chart clip	4 pcs
Foot-switch	1 pc
Anti-dust cover	1 pc
USB cable and software (only for ISP-A1000E)	1 pc

OPTIONAL ACCESSORY

20X lens with half-reflection mirror and oblique illuminator mirror	ISP-Z3015-LENS20X
50X lens with half-reflection mirror	ISP-Z3015-LENS50X
100X lens with half-reflection mirror	ISP-Z3015-LENS100X
Rotary table	ISP-Z3015-TABLE
Overlay chart	ISP-Z3015-CHART
Holder with clamp	ISP-Z3015-HOLDER

Swivel center support	ISP-Z3015-SUPPORT
V-block with clamp	ISP-Z3015-VBLOCK
50mm reading scale	ISP-Z3015-SCALE50
300mm calibration scale	ISP-Z3015-RULE
Blue filter	ISP-Z3015-FILTER
Demo sample	ISP-Z3015-DEMO
Printer (only for ISP-A1000E)	ISP-A1000-PRINTER

PROFILE PROJECTORS

Screen diameter: 300mm

X-Y travel: 200x100mm



ISP-AZ3020



edge detector

ISP-A5000E



16

digital readout of ISP-A5000E

- Adjust the focus by ascending and descending the projector head, the stage doesn't move up and down
- Maximum workpiece weight 50kg

- touch buttons
- USB data output to Excel and CAD
- show diagram directly

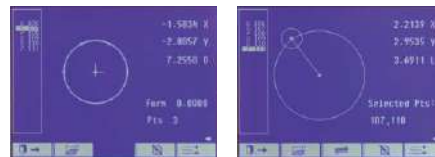

software CD (included, only for ISP-A5000E)

OPTIONAL ACCESSORY



lens



overlay chart (protractor with 1° graduation, radius with 1mm increment)



50mm reading scale (check magnification accuracy)



300mm calibration scale (check magnification accuracy together with 50mm reading scale or calibrate measuring accuracy)



demo sample



printer (only for ISP-A5000E)

To be continued



Continued from previous page

SPECIFICATION

Code		ISP-AZ3020		ISP-A5000E		
Edge detector		not included		included		
Lens	magnification	10X (included)	20X (optional)	50X (optional)	100X (optional)	
	view field	Ø30mm	Ø15mm	Ø6mm	Ø3mm	
	working distance	77.7mm	44.3mm	38.4mm	25.3mm	
Max. workpiece height		100mm	100mm	100mm	100mm	
Magnification accuracy		±0.08%				
Image		erect image				
Projector screen		diameter: Ø300mm				
		rotation range: 0°~360°, resolution: 1' or 0.01°				
		reference lines: cross-hairs				
Stage	metal stage size	404×228mm				
	glass stage size	260×160mm				
	X-Y stage travel	range: 200×100mm				
		resolution: 0.5µm				
	Z (focus) travel range	100mm				
max. load capacity	50kg					
Illumination		contour illumination: 24V/150W halogen lamp, brightness is adjustable				
		surface illumination: 24V/150W halogen lamp, brightness is adjustable				
Data processing unit	display	X-Y stage travel, screen rotation				
	output	RS232C		RS232C, USB (data output to Excel and CAD)		
	function		measure coordinate of point			
			measure coordinate of line			
		measure center coordinate, radius of circle with three points				
		measure distance between two objects				
		measure angle with four points or two lines				
		set origin of coordinate				
		coordinate transform				
		set midpoint of coordinate				
advanced function	—		programming for batch measurements			
Powersupply		110/220V, 50/60Hz				
Dimension (L×W×H)		780×780×1100mm				
Weight		160kg				

16

STANDARD DELIVERY

Main unit	1 pc
10X lens with half-reflection mirror and oblique illuminator mirror	1 pc
Overlay chart clip	4 pcs
Foot-switch	1 pc
Anti-dust cover	1 pc
USB cable and software (only for ISP-A5000E)	1 pc

OPTIONAL ACCESSORY

20X lens with half-reflection mirror and oblique illuminator mirror	ISP-A5000-LENS20X
50X lens with half-reflection mirror	ISP-A5000-LENS50X
100X lens with half-reflection mirror	ISP-A5000-LENS100X
Overlay chart	ISP-A5000-CHART

50mm reading scale	ISP-A5000-SCALE50
300mm calibration scale	ISP-A5000-RULE
Demo sample	ISP-A5000-DEMO
Printer (only for ISP-A5000E)	ISP-A5000-PRINTER

HORIZONTAL PROFILE PROJECTORS

Screen diameter: 300mm

X-Z travel: 200x100mm



ISP-W3020



ISP-A3000E



VIDEO

digital readout of ISP-A3000E

- touch buttons
- USB data output to Excel and CAD
- show diagram directly

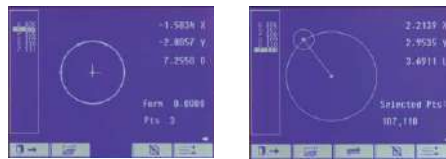

software CD (included, only for ISP-A3000E)

16

OPTIONAL ACCESSORY



lens



overlay chart (protractor with 1° graduation, radius with 1mm increment)



50mm reading scale (check magnification accuracy)



demo sample



V-block with clamp



rotary table



300mm calibration scale (check magnification accuracy together with 50mm reading scale or calibrate measuring accuracy)



vise



printer (only for ISP-A3000E)

To be continued



Continued from previous page

SPECIFICATION

Code		ISP-W3020	ISP-A3000E	
Edge detector		not included	included	
Lens	magnification	10X (included) 20X (optional)	50X (optional) 100X (optional)	
	view field	Ø30mm Ø15mm	Ø6mm Ø3mm	
	working distance	77.7mm 44.3mm	38.4mm 25.3mm	
Magnification accuracy		±0.08%		
Projector screen		diameter: Ø300mm		
		rotation range: 0°~360°, resolution: 1' or 0.01°		
		reference lines: cross-hairs		
Stage	metal stage size	400×150mm		
	turning range	±15°		
	X-Z stage travel	range: 200×100mm		
		resolution: 0.5µm		
	Y (focus) travel range	accuracy: (4+L/25)µm L is the measuring length in mm		
max. load capacity	75mm			
Illumination		contour illumination: 24V/150W halogen lamp, brightness is adjustable		
		surface illumination: 12V/150W halogen lamp (with 2 fibers), position is adjustable		
Data processing unit	display	X-Z stage travel, screen rotation		
	output	RS232C	RS232C, USB (data output to Excel and CAD)	
	function	measure coordinate of point		measure coordinate of point
		measure coordinate of line		measure coordinate of line
measure center coordinate, radius of circle with three points			measure center coordinate, radius of circle with three points	
measure distance between two objects			measure distance between two objects	
measure angle with four points or two lines			measure angle with four points or two lines	
set origin of coordinate			coordinate transform	
coordinate transform			choose measurement object automatically according to the selective point and display the result	
set midpoint of coordinate				
advanced function		—	programming for batch measurements	
Power supply		110/220V, 50/60Hz		
Dimension (L×W×H)		1090×830×1010mm		
Weight		160kg		

STANDARD DELIVERY

Main unit	1 pc
10X lens	1 pc
Overlay chart clip	4 pcs
Foot-switch	1 pc
Anti-dust cover	1 pc
USB cable and software (only for ISP-A3000E)	1 pc

OPTIONAL ACCESSORY

20X lens	ISP-A3000-LENS20X
50X lens	ISP-A3000-LENS50X
100X lens	ISP-A3000-LENS100X
Overlay chart	ISP-A3000-CHART
50mm reading scale	ISP-A3000-SCALE50
300mm calibration scale	ISP-A3000-RULE

Demo sample	ISP-A3000-DEMO
V-block with clamp	ISP-A1000-VBLOCK
Rotary table	ISP-A3000-RTABLE
Vice	ISP-A3000-VISE
Printer (only for ISP-A3000E)	ISP-A3000-PRINTER

HORIZONTAL PROFILE PROJECTORS

Screen diameter: 400mm

X-Z travel: 250x150mm



ISP-W4025

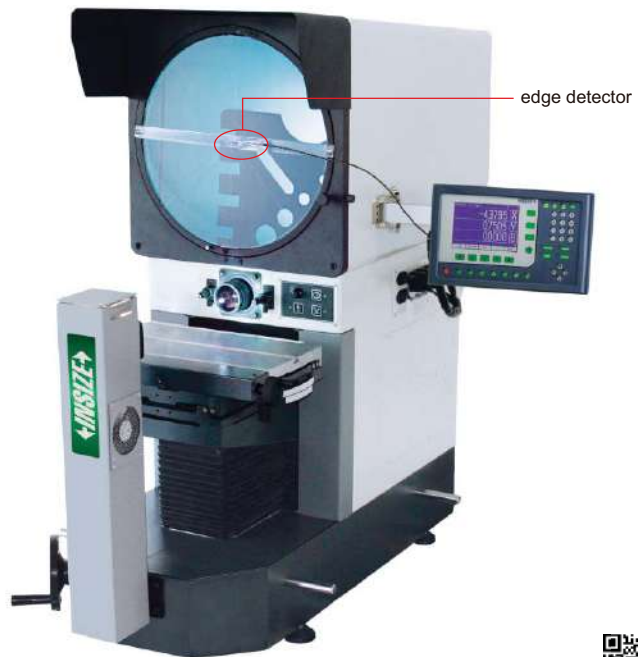

ISP-A7000E



digital readout of **ISP-A7000E**

- touch buttons
- USB data output to Excel and CAD
- show diagram directly

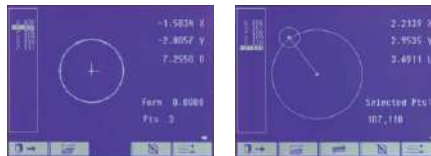

software CD (included, only for **ISP-A7000E**)

OPTIONAL ACCESSORY



lens



V-block with clamp



rotary table



demo sample (need rotary table)



vise



printer (only for **ISP-A7000E**)



300mm calibration scale (check magnification accuracy together with 50mm reading scale or calibrate measuring accuracy)



Ø300mm overlay chart (protractor with 1° graduation, radius with 1mm increment)



50mm reading scale (check magnification accuracy)

To be continued



Continued from previous page

SPECIFICATION

Code		ISP-W4025			ISP-A7000E		
Edge detector		not included			included		
Lens	magnification	5X (optional)	10X (standard)	20X (optional)	50X (optional)	100X (optional)	
	view field	Ø80mm	Ø40mm	Ø20mm	Ø8mm	Ø4mm	
	working distance	93.7mm	103.9mm	95.1mm	65.7mm	35mm	
Magnification accuracy		±0.08%					
Image		erect image					
Projector screen		diameter: Ø400mm					
		rotation range: 0°~360°, resolution: 1' or 0.01°					
		reference lines: cross-hairs					
Stage	metal stage size	450×200mm					
	turning range	±15°					
	X-Z stage travel	range: 250×150mm					
		resolution: 0.5µm					
	Y (focus) travel range	accuracy: (4+L/25)µm L is the measuring length in mm					
max. load capacity	100mm						
Illumination		contour illumination: 24V/150W halogen lamp, brightness is adjustable					
		surface illumination: 12V/150W halogen lamp(with 2 fibers), position is adjustable					
Data processing unit	display	X-Z stage travel, screen rotation					
	output	RS232C			RS232C, USB (data output to Excel and CAD)		
	function	measure coordinate of point	measure coordinate of point			measure coordinate of point	
		measure coordinate of line	measure coordinate of line			measure coordinate of line	
measure center coordinate, radius of circle with three points		measure center coordinate, radius of circle with three points			measure center coordinate, radius of circle with three points		
measure distance between two objects		measure distance between two objects			measure distance between two objects		
measure angle with four points or two lines		measure angle with four points or two lines			measure angle with four points or two lines		
set origin of coordinate		set origin of coordinate			coordinate transform		
coordinate transform		coordinate transform			choose measurement object automatically according to the selective point and display the result		
set midpoint of coordinate		set midpoint of coordinate					
advanced function		—			programming for batch measurements		
Power supply		110/220V, 50/60Hz					
Dimension (L×W×H)		1215×646×1210mm					
Weight		240kg					

STANDARD DELIVERY

Main unit	1 pc
10X lens	1 pc
Overlay chart clip	4 pcs
Foot-switch	1 pc
Anti-dust cover	1 pc
USB cable and software (only for ISP-A7000E)	1 pc

OPTIONAL ACCESSORY

5X lens	ISP-W4025-LENS5X
20X lens	ISP-W4025-LENS20X
50X lens	ISP-W4025-LENS50X
100X lens	ISP-W4025-LENS100X
Ø300mm overlay chart	ISP-A3000-CHART
50mm reading scale	ISP-A3000-SCALE50

300mm calibration scale	ISP-A3000-RULE
Demo sample	ISP-A3000-DEMO
V-block with clamp	ISP-A1000-VBLOCK
Rotary table	ISP-A3000-RTABLE
Vice	ISP-A3000-VISE
Printer (only for ISP-A7000E)	ISP-A3000-PRINTER

VISION MEASURING SYSTEMS

INSPECTION CERTIFICATE



lens with coaxial light (optional, must be installed in factory)

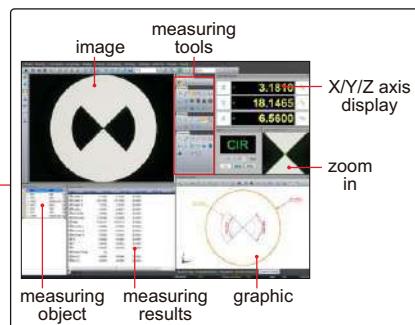

ISD-V250A

computer is included

SPECIFICATION

Code	ISD-V150A	ISD-V250A	ISD-V300A	ISD-V400A
Measuring range (X×Y×Z)	150×100×200mm	250×150×200mm	300×200×200mm	400×300×200mm
Stage size	354×228mm	450×280mm	500×330mm	606×466mm
Stage glass size	210×160mm	306×196mm	350×250mm	450×350mm
Resolution of X/Y/Z axis	0.5μm			
Accuracy of X/Y axis	≤(2.5+L/100)μm (L is the measuring length in mm)			
Repeatability of X/Y axis	2μm			
Objective	0.7X~4.5X (zoom)			
Working distance	92mm			
Magnification	33X~195X (on 19" monitor)			
Camera	1/3" color CCD, 0.3M pixel			
Illumination	surface and contour with adjustable LED			
Max. height of workpiece	160mm			
Max. weight of workpiece	20kg			
Operation system	Windows 7/8/10			
Drive method	manual			
Power supply	110/220V, 50/60Hz			
Dimension (L×W×H)	560×540×850mm	760×600×900mm	760×600×900mm	970×670×940mm
Weight	100kg	120kg	140kg	240kg

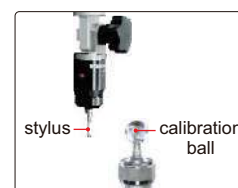

probe (optional), includes Ø2mm and Ø3mm styli, Ø25mm calibration ball, measuring accuracy is 10μm

STANDARD DELIVERY

Main unit	1 pc
Computer	1 pc
Calibration glass chart	1 pc
Clay	1 pc
Foot switch	1 pc
Anti-dust cover	1 pc

SOFTWARE

- Operation system: Windows 7/8/10
- Language: English
- Single measuring tools:

measure coordinate of point	measure center coordinate, diameter and area of circle
measure distance of two elements	measure length, width and diameter of key slot
measure focus distance of surface	measure length, width and area of rectangle
measure distance between two points	measure length and diameter of arc
measure width and diameter of ring	measure length and area of closed curve
measure angle of two lines	measure center coordinate and axis length of ellipse
measure length of open curve	

OPTIONAL ACCESSORY

0.5X auxiliary objective	Code: ISD-V-OB05X Working distance: 175mm Magnification: 16.5~97.5X (on 19" monitor)
2X auxiliary objective	Code: ISD-V-OB2X Working distance: 36mm Magnification: 66~390X (on 19" monitor)
Probe	Code: ISD-V-PROBE Includes Ø2mm and Ø3mm styli, Ø25mm calibration ball
Vision measuring system with coaxial light lens (with computer)	Code: ISD-V150ACL, ISD-V250ACL, ISD-V300ACL, ISD-V400ACL

To be continued

Continued from previous page

■ **Combined measuring tools:**

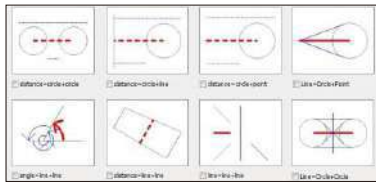

measure distance and angle of two elements

■ **Focus indicator:**

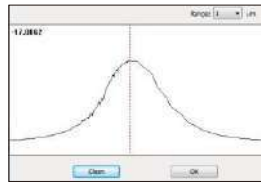

■ **CAD measuring:**

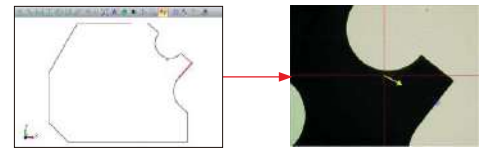

Input CAD drawing and set reference, move the stage to make the target box in the center of crosshair, then the software will do automatic measurement

■ **Coordinate transfer:**

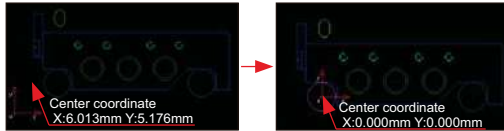

Center coordinate
X:6.013mm Y:5.176mm

Center coordinate
X:0.000mm Y:0.000mm

■ **Edge-detection:**



■ **Data export to CAD, EXCEL and WORD:**

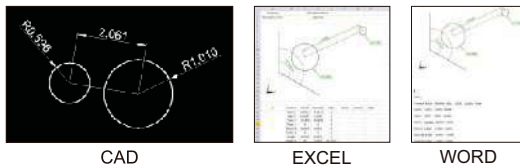

CAD

EXCEL

WORD

■ **Contour scanning:**

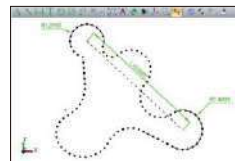

■ **Profile detection:**



CNC VISION MEASURING SYSTEMS

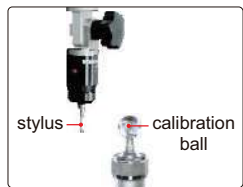

probe (optional), includes Ø2mm and Ø3mm styli, Ø25mm calibration ball, measuring accuracy is 10µm



lens with coaxial light (included)



programmable segmented ring light (included)



ISD-V220CNCA

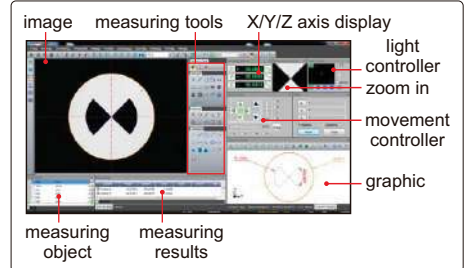

image measuring tools X/Y/Z axis display light controller zoom in movement controller graphic



computer is included



controller

STANDARD DELIVERY

Main unit	1 pc
Computer	1 pc
Controller	1 pc
Calibration glass chart	1 pc
Clay	1 pc
Anti-dust cover	1 pc

- Automatic edge-detection, focus, measuring, contour scanning, calibration, etc.
- Servo motors for X, Y, Z axis
- SPC function for large quantity measurement

To be continued

Continued from previous page

SPECIFICATION

Code	ISD-V220CNCA **	ISD-V270CNCA **	ISD-V370CNCA **
Measuring range (X×Y×Z)	220×120×150mm	270×170×150mm	370×270×150mm
Stage size	450×280mm	500×330mm	606×466mm
Glass stage size	306×196mm	350×250mm	450×350mm
Resolution of X/Y/Z axis	0.5μm		
Accuracy of X/Y axis	≤(2.5+L/100)μm (L is the measuring length in mm)		
Repeatability of X/Y axis	2μm		
Objective	0.7X~4.5X (zoom)		
Working distance	92mm		
Magnification	20X~128X (on 19.5" monitor)		
Camera	1/2" color CCD, 0.4M pixel		
Illumination	surface	coaxial light, programmable segmented ring light	
	contour	adjustable LED light	
View field (diagonal length)	1.7~11.1mm		
Max. height of workpiece	160mm		
Max. weight of workpiece	30kg		
Operation system	Windows 7/8/10		
Drive method	Automatic		
Power supply	220V, 50/60Hz **		
Dimension (L×W×H)	760×600×900mm	760×600×900mm	970×670×940mm
Weight	146kg	168kg	266kg

** Add "-U" on code NO. when power supply is 110V, 50/60HZ

OPTIONAL ACCESSORY

0.5X auxiliary objective	Code: ISD-V-OB05X Working distance: 175mm Magnification: 10~64X (on 19.5" monitor)
2X auxiliary objective	Code: ISD-V-OB2X Working distance: 36mm Magnification: 40~256X (on 19.5" monitor)
Probe	Code: ISD-V-PROBE Includes Ø2mm and Ø3mm styli, Ø25mm calibration ball

SOFTWARE

- Operation system: Windows 7/8/10
- Language: English
- Single measuring tools:

	measure distance between two points		measure length and area of closed curve		measure coordinate of point
	measure length and diameter of arc		measure center coordinate and axis length of ellipse		measure angle of two lines
	measure width and diameter of ring		measure length, width and diameter of key slot		measure distance of two elements
	measure focus distance of surface		measure length, width and area of rectangle		measure length of open curve
	measure center coordinate, diameter and area of circle				

■ Combined measuring tools:

measure distance and angle of two elements

■ Focus indicator:

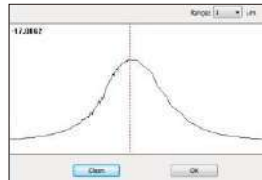

■ CAD measuring:

Input CAD drawing and set reference, move the stage to make the target box in the center of crosshair, then the software will do automatic measurement

■ Edge-detection:

Point tool Box tool Circle tool

■ Coordinate transfer:

■ Data export to CAD, EXCEL and WORD:

CAD EXCEL WORD

■ Contour scanning:

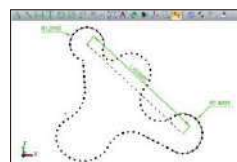

■ Profile detection:

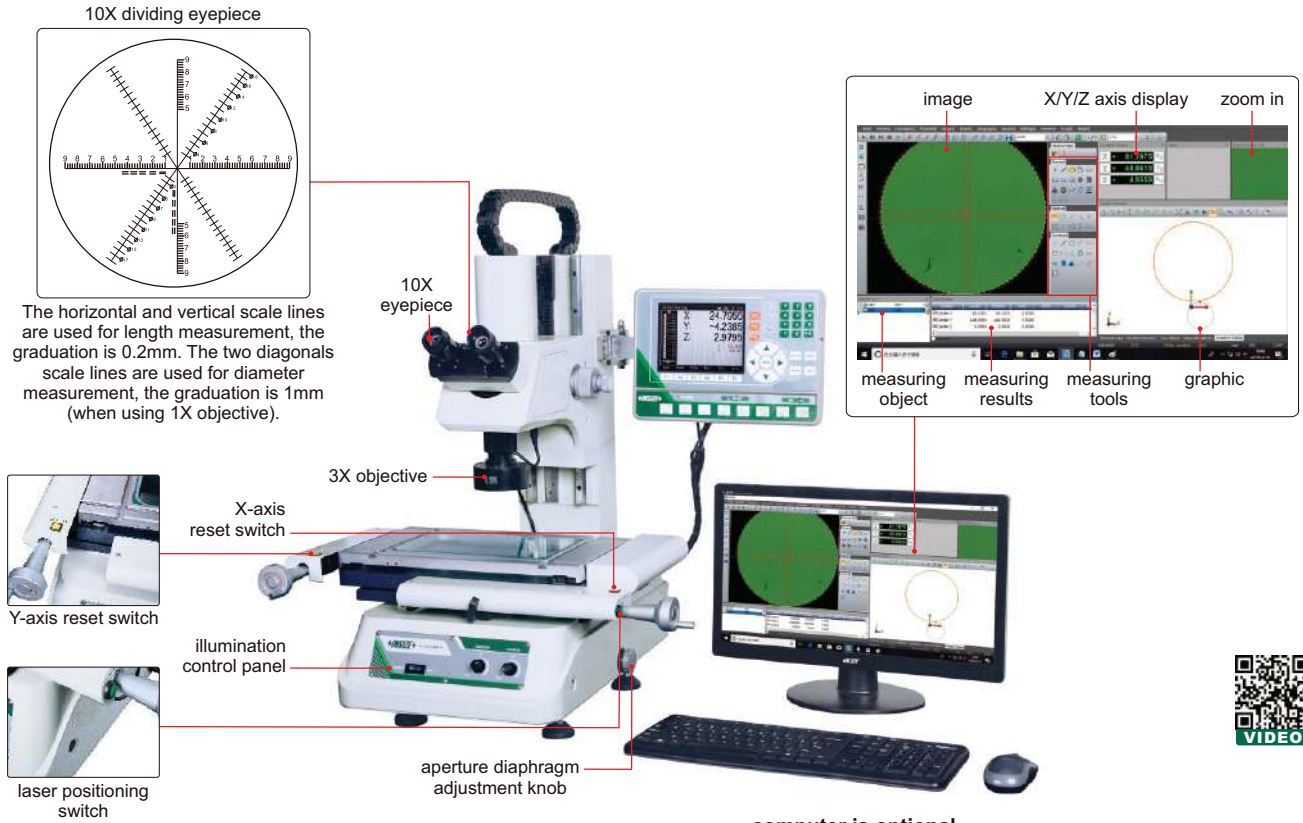

ISD-VMM215

computer is optional

SPECIFICATION

Code	Binocular	ISD-VMM205	ISD-VMM215	ISD-VMM225	ISD-VMM235
	Monocular	ISD-VMM205D	ISD-VMM215D	ISD-VMM225D	ISD-VMM235D
X/Y axis travel		150×100mm	200×100mm	250×150mm	300×200mm
Z axis travel		150mm	150mm	200mm	200mm
Metal stage size		354×228mm	404×228mm	450×280mm	500×330mm
Glass stage size		210×160mm	260×160mm	306×196mm	350×250mm
Resolution of X/Y/Z axis		0.5μm			
Accuracy of X/Y axis		≤(2.5+L/100)μm (L is the measuring length in mm)			
Repeatability		2μm			
Camera		1/3" color CCD, 0.3M pixel			
Optical magnification		30X			
Image magnification		114X (on 19" monitor)			
Illumination		surface and contour with adjustable LED			
Max. weight of workpiece		25kg			
Power supply		100V~240V, 50/60Hz			
Operating system		Windows 7/8/10			
Drive method		manual			
Dimension (L×W×H)		540×667×850mm	540×667×850mm	800×675×920mm	800×675×920mm
Weight		100kg	110kg	135kg	140kg

To be continued

Continued from previous page

DATA PROCESSING UNIT

Output	RS232
Function	Easy measuring tools
	Measure coordinate of points
	Measure lines
	Measure center coordinate, radius of circle with three points
	Measure distances between two objects
	Measure angles
	Set origin of coordinate
	Skew and calibrate the workpiece
	Measure rectangle (including length, width, perimeter and center coordinate)
	Measure thread (including thread diameter, screw pitch, screw angle)
	Measure slot (including center coordinate, length, width)

STANDARD DELIVERY

Main unit	1 pc
Video card with dongle	1 pc
Software disc	1 pc
Calibration glass chart	1 pc
Demo sample	1 pc
Foot switch	1 pc
3X objective	1 pc

OPTIONAL ACCESSORY

1X objective	ISD-VMM-LENS1X
5X objective	ISD-VMM-LENS5X
10X objective	ISD-VMM-LENS10X
Printer	ISD-VMM-PRINTER
Toolmaker microscopes (with computer)	Code: ISD-VMM205A (binocular) ISD-VMM215A (binocular) ISD-VMM225A (binocular) ISD-VMM235A (binocular)
	Code: ISD-VMM205DA (monocular) ISD-VMM215DA (monocular) ISD-VMM225DA (monocular) ISD-VMM235DA (monocular)

SOFTWARE

- **Operation system:** Windows 7/8/10
- **Language:** English
- **Single measuring tools:**

measure distance between two points	measure length and area of closed curve	measure coordinate of point
measure length and diameter of arc	measure center coordinate and axis length of ellipse	measure angle of two lines
measure width and diameter of ring	measure length, width and diameter of key slot	measure distance of two elements
measure focus distance of surface	measure length, width and area of rectangle	measure length of open curve
measure center coordinate, diameter and area of circle		

■ Combined measuring tools:

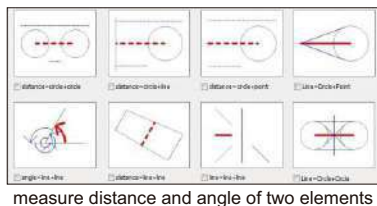

■ Focus indicator:

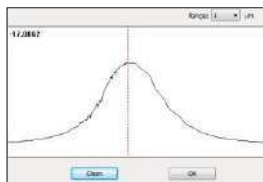

■ CAD measuring:

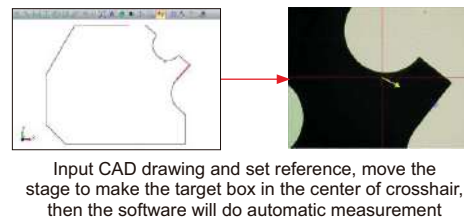

■ Edge-detection:



■ Coordinate transfer:



■ Data export to CAD, EXCEL and WORD:

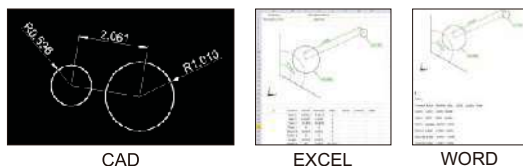

■ Contour scanning:

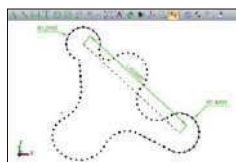

■ Profile detection:



AUTO FOCUS

TAKE PICTURES
AND VIDEOS

AUTO FOCUS DIGITAL MICROSCOPE CODE 5302-AF105

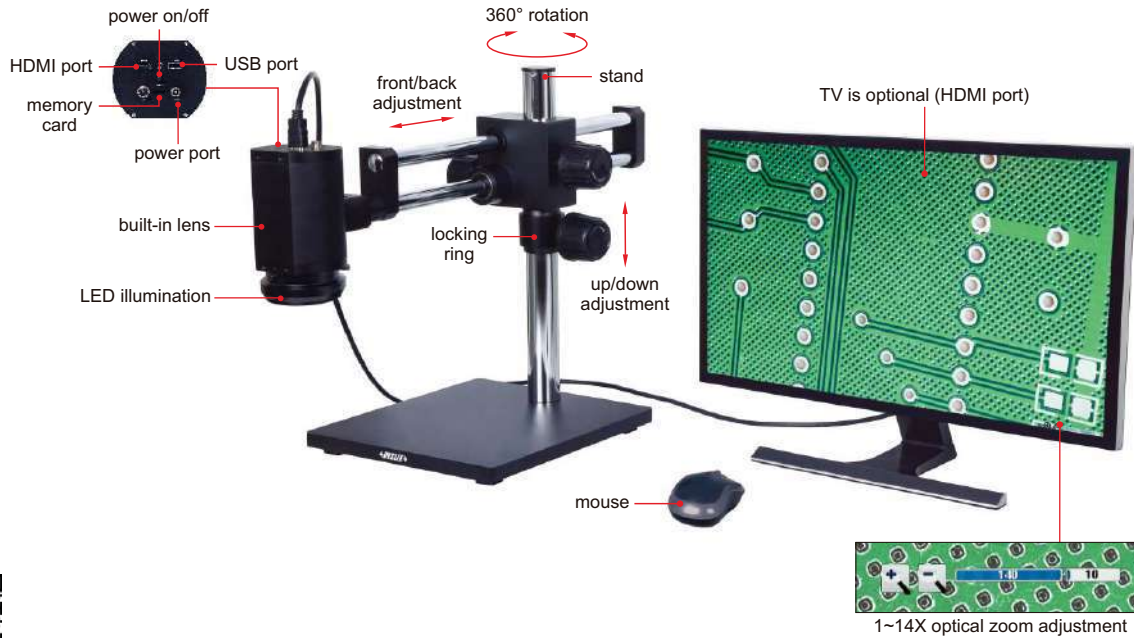

- 1080P high-definition image
- Auto focus camera
- Take pictures and videos, saved to memory card
- Connected to TV by HDMI port
- Automatic exposure and white balance
- Brightness, contrast ratio, gain are adjustable
- Display cross hair (blue/green/red/yellow/black/brown colors)

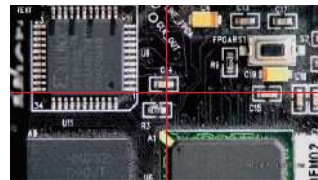

display cross hair
(blue/green/red/yellow/black/brown colors)



8G memory card
and holder (included)

SPECIFICATION

Magnification	1.8X~27.5X (on 28" TV)
Sensor	1/2.8" CMOS
Pixel	2M
Resolution	1920×1080
Frame rate	60fps
Auto focus distance	100mm~∞
Output	HDMI
Power supply	power adapter
Dimension (L×W×H)	500×280×410mm
Weight	17kg

STANDARD DELIVERY

Main unit (with stand)	1 pc
LED illumination	1 pc
8G memory card and holder	1 pc
Mouse	1 pc
HDMI cable (for TV)	1 pc
Power adapter	2 pcs

FOCUS DISTANCE, MAGNIFICATION AND VIEW FIELD (MANUAL FOCUS)

Focus distance	Adjustable magnification (on 28" TV)	View field
100mm	4.5~27.5X	24×14~161×90mm
150mm	3~21X	30×17~240×128mm
200mm	2.3~17.5X	38×20~305×176mm
250mm	2~15X	42×24~320×210mm
270mm	1.8~14.4X	43×25~378×240mm

AUTO FOCUS DIGITAL MICROSCOPE (WITH DISPLAY) CODE 5303-AF103

AUTO FOCUS

TAKE PICTURES
AND VIDEOS

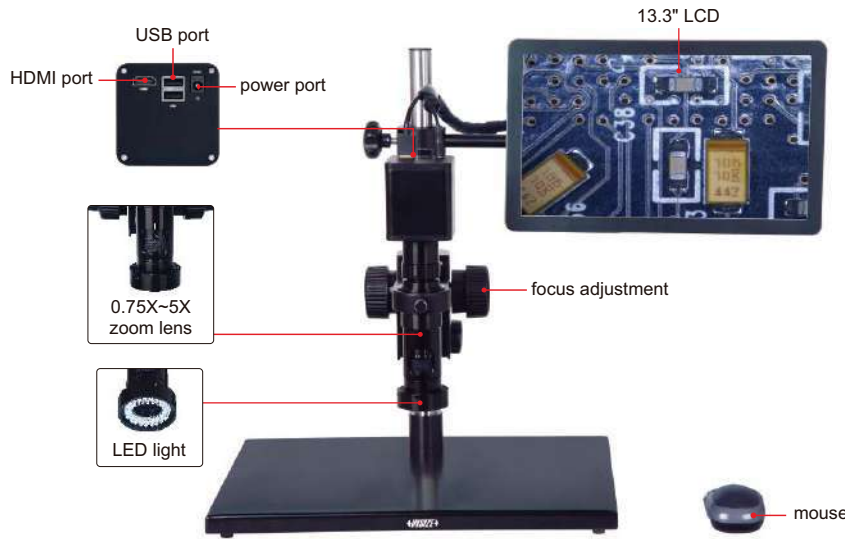

0.5X camera adapter
(included)



1X auxiliary objective
(included)



16G USB flash disk
(included)

- 1080P high-definition image
- Auto focus camera
- Take pictures and videos, saved to USB flash disk
- Picture review, picture compare
- Automatic exposure and white balance
- Brightness, contrast ratio, gain are adjustable
- Display cross hair (blue/green/red/yellow/black/brown colors)

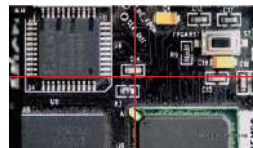

display cross hair
(blue/green/red/yellow/
black/brown colors)



1X camera adapter
(optional)



2X auxiliary objective
(optional)

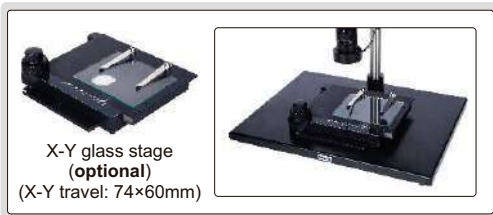

X-Y glass stage
(optional)
(X-Y travel: 74×60mm)

MAGNIFICATION, FOCUS DISTANCE AND VIEW FIELD

Auxiliary objective	Specification	Camera adapter	
		0.5X (included)	1X (optional)
1X (included)	Magnification	20~123X	40~246X
	Focus distance	48~84mm	48~84mm
	View field	13×7~2.2×1mm	6.3×3.5~1.1×0.5mm
2X (optional)	Magnification	40~246X	80~492X
	Focus distance	24~42mm	24~42mm
	View field	6.5×3.5~1.1×0.5mm	3.3×1.8~0.6×0.3mm

SPECIFICATION

Magnification	20X~123X
Sensor	1/2.8" CMOS
Pixel	2M
Resolution	1920×1080
Frame rate	60fps
Output	HDMI
Power supply	power adapter
Dimension (L×W×H)	570×300×430mm
Weight	6.5kg

AUTO FOCUS DISTANCE

Zoom objective scale	0.75X	1X	1.5X	2X	2.5X
Auto focus distance	48~84mm	50~78mm	55~73mm	62~71mm	65~70mm

Zoom objective scale	3X	3.5X	4X	4.5X	5X
Auto focus distance	66~70mm	67~70mm	68~70mm	68~70mm	68~70mm

STANDARD DELIVERY

Main unit	1 pc
0.5X camera adapter	1 pc
1X auxiliary objective	1 pc
16G USB flash disk	1 pc
White/black plate	1 pc
Mouse	1 pc
HDMI cable	1 pc
Power adppter	2 pcs

OPTIONAL ACCESSORY

1X camera adapter	ISM-DL-CA1X
2X auxiliary objective	ISM-DL-OB2X
X-Y glass stage (travel: 74×60mm)	ISM-DL-STAGE
X-Y metal stage	ISM-DL-STAGE1
LED auxiliary lighting	ISM-DL-LED
Lens with coaxial light	ISM-DL-COAXIAL
Auxiliary objective	Page 276

SUITABLE TO CHECK CONVEX OBJECTS AND WALL OF HOLE

3D MOTORIZED ROTATION MICROSCOPE (WITH DISPLAY) CODE 5301-D400

TAKE PICTURES AND VIDEOS

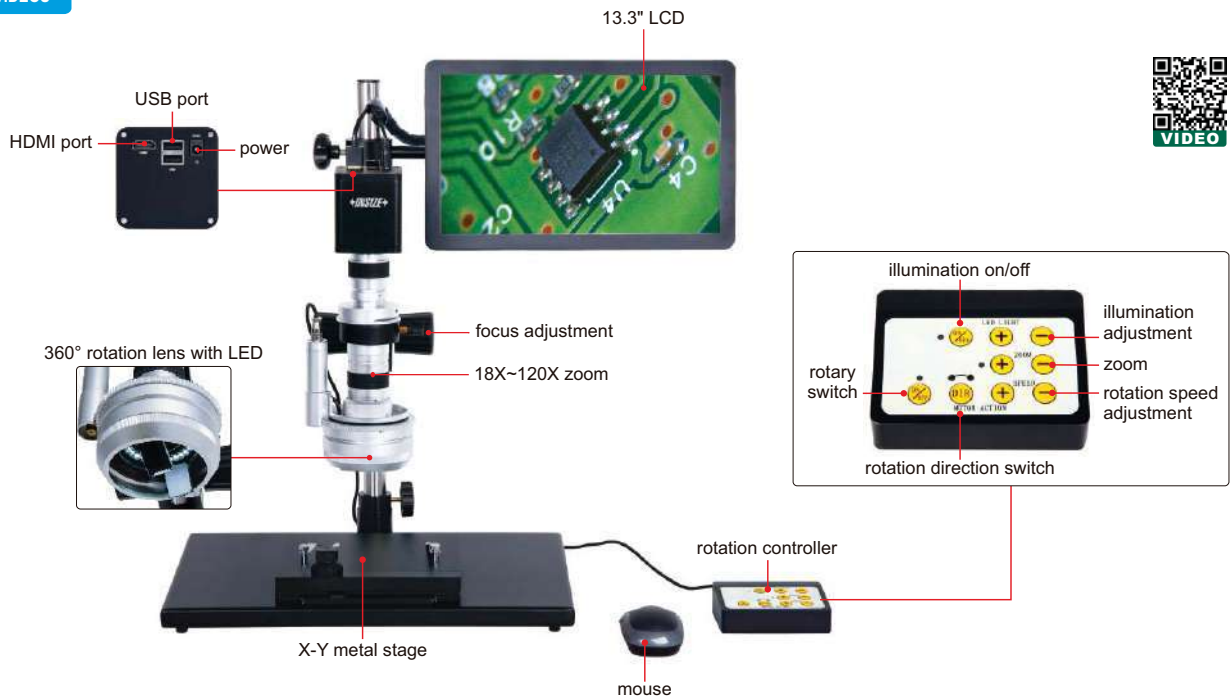

working principle

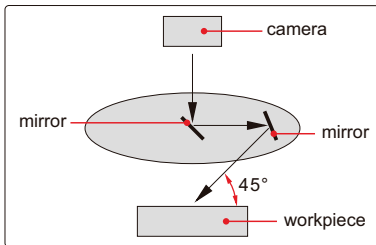

- 1080P high-definition 3D image
- Take pictures and videos, save to USB flash disk
- Automatic white balance and exposure
- Brightness, contrast ratio and gain are adjustable

SPECIFICATION

Magnification	18X~120X
View field	2.4×1.5mm~16×9mm
Focus distance	20mm
View angle	45°
Sensor	1/2.8" CMOS
Pixel	2M
Resolution	1920×1080
Frame rate	60fps
Output	HDMI
Rotation speed	2~5RPM
Power supply	110/220V, 50/60Hz
Dimension (L×W×H)	570×300×430mm
Weight	10kg

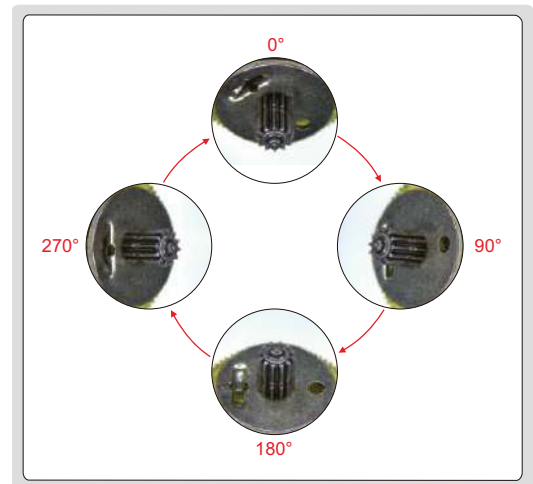

360° rotation observation

STANDARD DELIVERY

Main unit	1 pc
Rotation controller	1 pc
X-Y metal stage	1 pc
16G USB flash disk	1 pc
White/black plate	1 pc
Mouse	1 pc
Power adapter	2 pcs

DIGITAL MEASURING MICROSCOPES (WITH DISPLAY)

BUILT-IN SOFTWARE WITHOUT COMPUTER

MEASUREMENT

TAKE PICTURES

ATTENTION: PLEASE MAKE CONFOCAL ADJUSTMENT AFTER CHANGING CAMERA ADAPTERS OR AUXILIARY OBJECTIVES

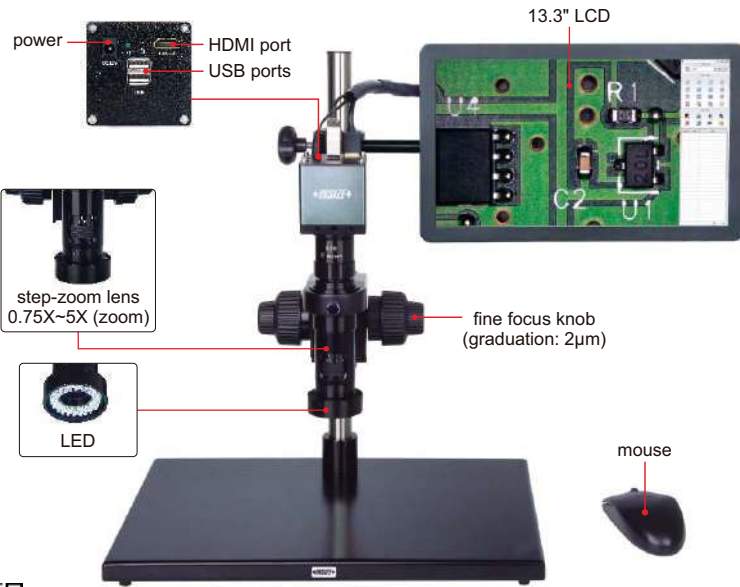

ISM-DL300 (without contour illumination)

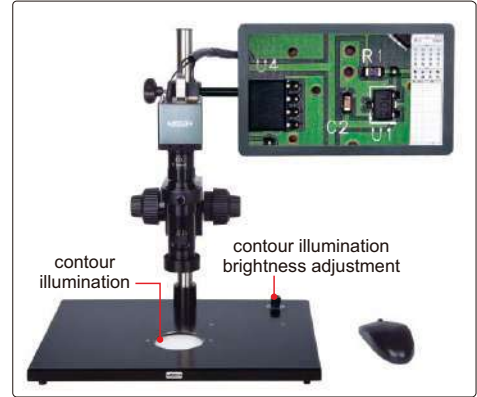

ISM-DL301 (with contour illumination)



- 1080P high-definition image
- Built-in software without computer, operated by mouse
- Take pictures, save to USB flash disk
- Measurement results can be sent to Excel
- Automatic white balance and exposure
- Brightness, contrast ratio, gain are adjustable



0.5X camera adapter (included)



1X auxiliary objective (included)



1X camera adapter (optional)



calibration plate (included)



16G USB flash disk (included)



2X auxiliary objective (optional)



X-Y glass stage (optional)
(X-Y travel: 74×60mm)



SPECIFICATION

Code	ISM-DL300 (without contour illumination)	ISM-DL301** (with contour illumination)
Magnification	15X~100X	
Sensor	1/2" CMOS	
Pixel	2M	
Resolution	1920×1080	
Frame rate	60fps	
Output	HDMI	
Power supply	power adapter	power adapter and 220V, 50/60Hz**
Dimension (L×W×H)	570×300×430mm	
Weight	6.5kg	

** Add "-U" on code No. when power supply is 110V, 50/60Hz

STANDARD DELIVERY

Main unit	1 pc
0.5X camera adapter	1 pc
1X auxiliary objective	1 pc
Calibration plate	1 pc
16G USB flash disk	1 pc
White/black plate	1 pc
Mouse	1 pc
HDMI cable	1 pc
Power adapter	2 pcs

OPTIONAL ACCESSORY

1X camera adapter	ISM-DL-CA1X
2X auxiliary objective	ISM-DL-OB2X
X-Y glass stage (travel: 74×60mm)	ISM-DL-STAGE
X-Y metal stage	ISM-DL-STAGE1
LED auxiliary illumination	ISM-DL-LED
Coaxial light illumination	ISM-DL-COAXIAL
Auxiliary objective	page 276

To be continued

Continued from previous page

MEASURING ACCURACY

Objective magnification	Measuring accuracy *
0.75X	±8μm
1X	±7μm
1.5X	±6μm
2X	±6μm
2.5X	±6μm
3X	±5μm
3.5X	±5μm
4X	±4μm
4.5X	±4μm
5X	±4μm

* When measuring the contour of workpieces, please use **ISM-DL301** to ensure accuracy.

MAGNIFICATION, FOCUS DISTANCE AND VIEW FIELD

Auxiliary objective	Specification	Camera adapter	
		0.5X (included)	1X (optional)
1X (included)	Magnification	15~100X	30~200X
	Focus distance	70±2mm	70±2mm
	View filed	16×11~2.5×1.6mm	7.8×5.3~1.2×0.8mm
2X (optional)	Magnification	30~200X	60~400X
	Focus distance	29±2mm	29±2mm
	View filed	7.8×5.3~1.2×0.8mm	3.8×2.7~0.6×0.4mm

SOFTWARE

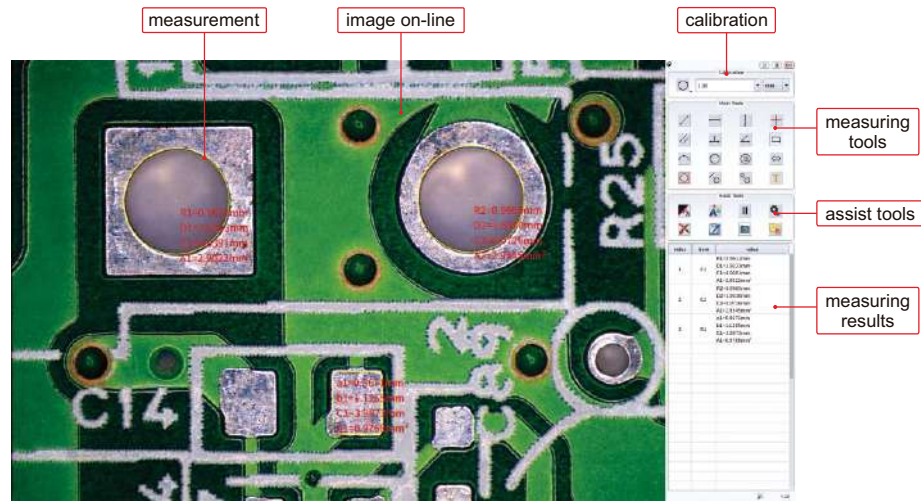

- Language: English
- Output to Excel
- Edge-detection:

Point tool

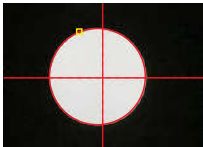

Box tool

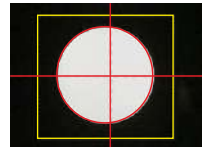

Click tool

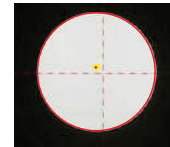

Measurement tools:

- | | | | | | |
|--|--|--|---|--|---|
| | measure length of line or distance between two points | | measure length of line or distance between two points in horizontal direction | | measure length of line or distance between two points in vertical direction |
| | measure angle from horizontal line | | measure angle from vertical line | | measure angle of two lines |
| | measure distance between two parallel lines | | measure distance between three parallel lines | | measure distance between multiple parallel lines |
| | measure distance between point and line | | measure radius, length and angle of arc | | measure girth and area of polygon |
| | measure radius, diameter, girth and area of circle with three points | | measure radius, diameter, girth and area concentric of circles | | measure length, width, girth and area of rectangle |
| | measure minimum distance between point and circle | | measure distance between point and center of circle | | measure maximum distance between point and circle |
| | measure minimum distance between line and circle | | measure distance between line and center of circle | | measure maximum distance between line and circle |
| | measure minimum distance between two circles | | measure center distance between two circles | | measure maximum distance between two circles |
| | add text | | measure radius, diameter, girth and area of circle with two points | | cross hair |

HIGH MAGNIFICATION MEASURING MICROSCOPE (WITH DISPLAY) CODE ISM-DL302

REFER TO ISM-DL300 FOR
SOFTWARE FUNCTION

OBSERVATION AND MEASUREMENT
AT HIGH MAGNIFICATION

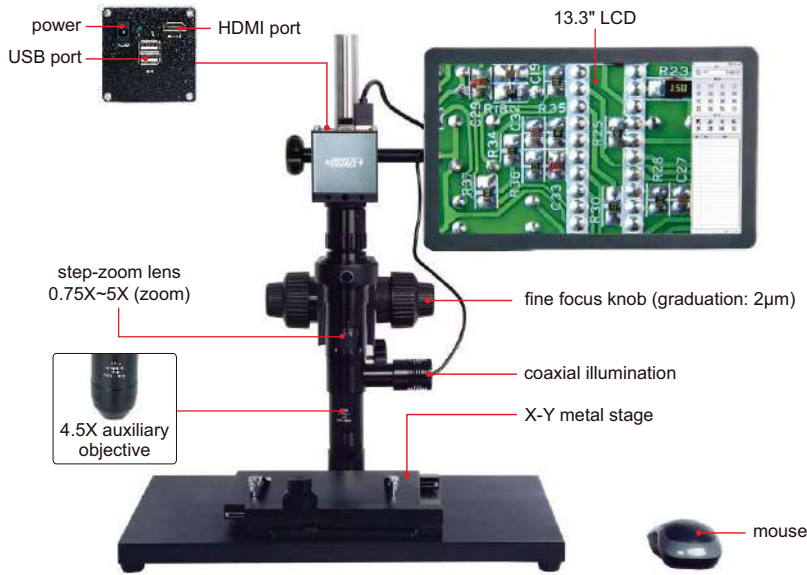

- 1080P high-definition image
- Maximum 1000X optical magnification (using camera adapter 1X, optional)
- Built-in software without computer, operated by mouse
- Solid base and column to avoid lens shaking during focusing

SPECIFICATION

Magnification	78X~504X
Sensor	1/2" CMOS
Pixel	2M
Resolution	1920×1080
Frame rate	60fps
Output	HDMI
Power supply	power adapter
Dimension(L×W×H)	570×300×430mm
Weight	15kg

SATNDARD DELIVERY

Main unit	1 pc
0.5X camera adapter	1 pc
4.5X auxiliary objective	1 pc
Coaxial illumination	1 pc
Calibration plate	1 pc
16G USB flash disk	1 pc
Mouse	1 pc
HDMI cable	1 pc
X-Y metal stage	1 pc

OPTIONAL ACCESSORY

1X camera adapter	ISM-DL-CA1X
LED auxiliary illumination	ISM-DL-LED



coaxial illumination
(included)



calibration plate
(included)



0.5X camera adapter
(included)



16G USB flash disk
(included)



LED auxiliary illumination
(optional)



1X camera adapter
(optional)

MAGNIFICATION, FOCUS DISTANCE AND VIEW FIELD

Camera adapter	0.5X (included)	1X (optional)
Magnification	78~504X	156~1008X
Focus distance	14±2mm	14±2mm
View field	2.8×1.7~0.5×0.3mm	1.4×0.9~0.3×0.2mm

BUILT-IN SOFTWARE
WITHOUT COMPUTER



DIGITAL MEASURING MICROSCOPE (BASIC TYPE) CODE 5307-ID100

adjustable display angle



- Built-in software without computer, operated by mouse
- Take pictures, save to USB flash disk
- Measuring results can be sent to Excel



SPECIFICATION

Sensor	1/2" CMOS
Pixel	2M
Resolution	1920×1080
Frame rate	60fps
Output	USB/HDMI
Power supply	power adapter
Dimension (L×W×H)	610×610×660mm
Weight	4.5kg

STANDARD DELIVERY

Main unit	1 pc
Calibration plate	1 pc
Power adapter	1 pc
Mouse	1 pc
16G USB flash disk	1 pc

OPTIONAL ACCESSORY

0.75X auxiliary objective	5307-ID100-OB07X
2X auxiliary objective	5307-ID100-OB2X

MEASURING ACCURACY*

Objective magnification	Measuring accuracy
0.7X	±9μm
1X	±9μm
1.5X	±8μm
2X	±7μm
2.5X	±7μm
3X	±7μm
3.5X	±6μm
4X	±6μm
4.5X	±5μm

MAGNIFICATION, FOCUS DISTANCE AND VIEW FIELD

Specification	Auxiliary objective		
	0.75X (optional)	1X (included)	2X (optional)
Magnification	8~54X	11~73X	22~146X
Focus distance	132±2mm	105±2mm	46±2mm
View field	4.7×2.7~30.5×16mm	3.4×2~23×13mm	1.8×1~11.3×6.4mm

*Using 1X auxiliary objective (included)

SOFTWARE

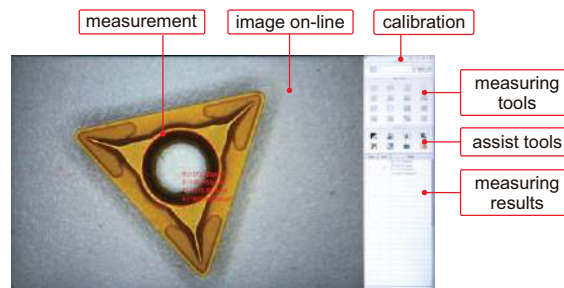

- Language: English
- Output to Excel
- Edge-detection
- Measurement tools:

measure length of line or distance between two points

measure distance between two parallel lines

measure distance between point and line

measure radius, diameter, girth and area of circle with three points

measure minimum distance between point and circle

cross hair

measure length of line or distance between two points in horizontal direction

measure radius, length and angle of arc

measure radius, diameter, girth and area concentric of circles

measure distance between line and center of circle

add text

measure length of line or distance between two points in vertical direction

measure angle of two lines

measure girth and area of polygon

measure length, width, girth and area of rectangle

measure center distance between two circles

SMART MICROSCOPE CODE ISM-DL400**

**AUTOMATICALLY LOCATE WORKPIECES
REGARDLESS OF POSITION AND DIRECTION**

**BUILT-IN SOFTWARE
WITHOUT COMPUTER**

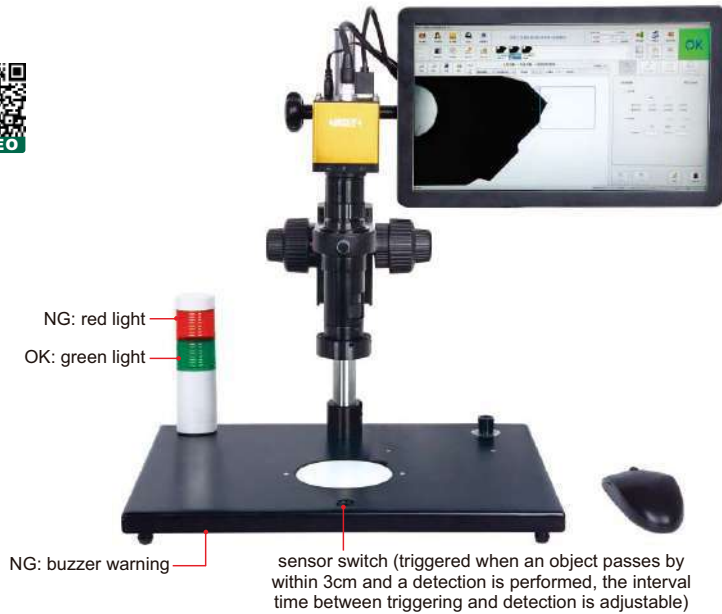

- Automatically identify different workpieces
- Automatically locate workpieces regardless of position and direction
- Built-in software, PLC control input and output interface
- Including multiple detection tools
- Automatically calculate, store the test results and export to Excel

camera function

■ surface defect detection	■ character recognition
■ dimension measurement	■ color detection
■ read barcode	■ read QR code
■ burr detection	■ object counting
■ contour matching	■ thread measurement

detect multiple different workpieces at one time

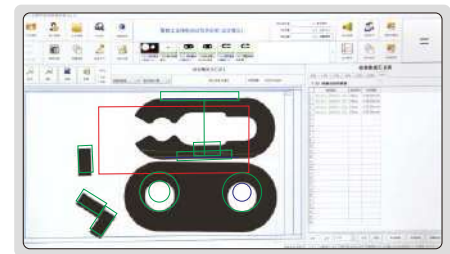

report showing the perform times of each tool, quantity of OK and NG, the report can be saved

report of each detection is automatically created and saved

SPECIFICATION

Magnification	15X~100X
Resolution	1920×1080
Pixel	2M
Single pixel size	3.75×3.75μm
Frame rate	60fps
Sensor	1/2" CMOS
Chip structure	FPGA+ARM
Operating system	Linux 3.10
Power supply	220V, 50/60Hz **
Dimension (L×W×H)	570×300×430mm
Weight	6.5kg

** Add "-U" on code No. when power supply is 110V, 50/60Hz

STANDARD DELIVERY

Main unit	1 pc
0.5X camera adapter	1 pc
1X auxiliary objective	1 pc
Calibration plate	1 pc
16G USB flash disk	1 pc
White/black plate	1 pc
HDMI cable	1 pc
Power adapter	2 pcs

MAGNIFICATION, FOCUS DISTANCE AND VIEW FIELD

Auxiliary objective	Specification	Camera adapter	
		0.5X (included)	1X (optional)
1X (included)	Magnification	15~100X	30~200X
	Focus distance	70±2mm	70±2mm
	View filed	16×11~2.5×1.6mm	7.8×5.3~1.2×0.8mm
2X (optional)	Magnification	30~200X	60~400X
	Focus distance	29±2mm	29±2mm
	View filed	7.8×5.3~1.2×0.8mm	3.8×2.7~0.6×0.4mm

OPTIONAL ACCESSORY

1X camera adapter	ISM-DL-CA1X
2X auxiliary objective	ISM-DL-OB2X
LED auxiliary illumination	ISM-DL-LED
Coaxial light illumination	ISM-DL-COAXIAL
Auxiliary objective	page 276

To be continued

Continued from previous page

▪ APPLICATION EXAMPLES:

dimension measurement

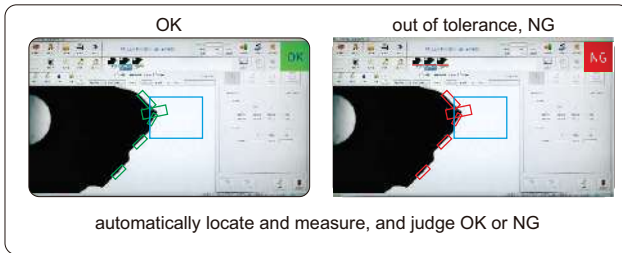

thread measurement

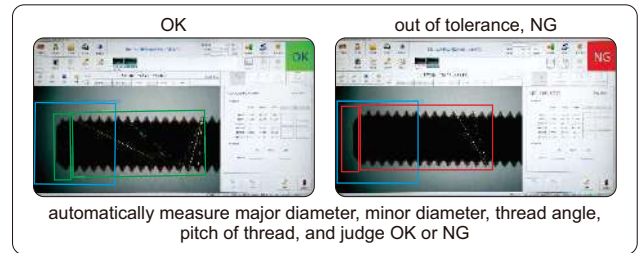

cutting tools measurement

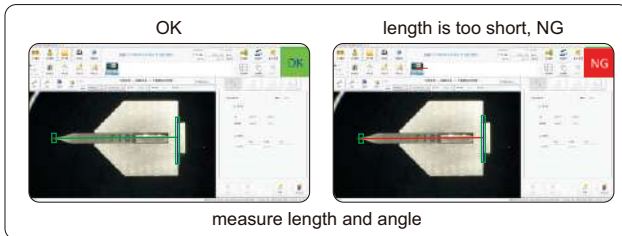

counting

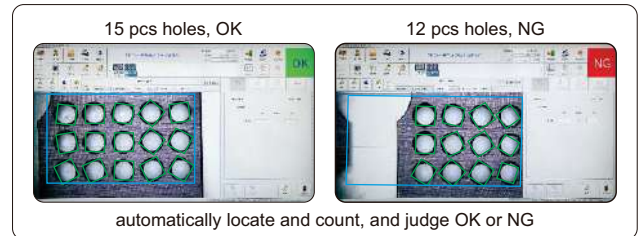

existence or absence

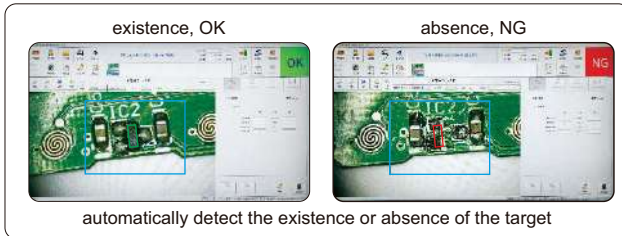

character recognition

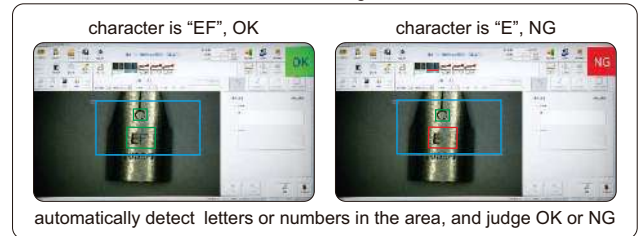

color detection

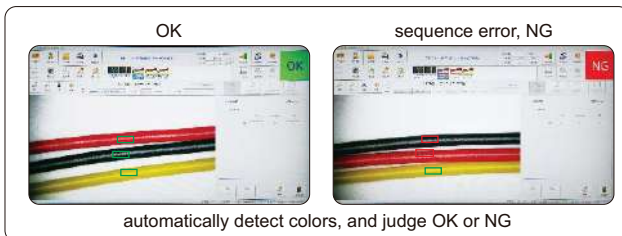

location detection

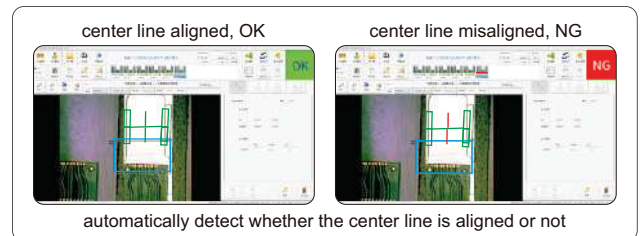

surface defect detection

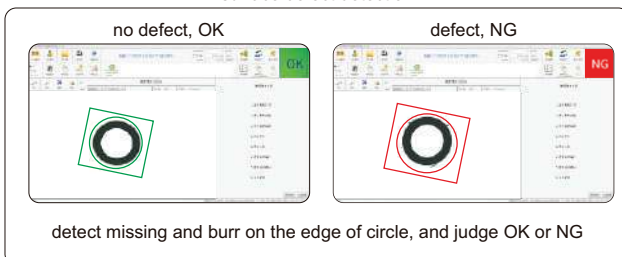

glue detection

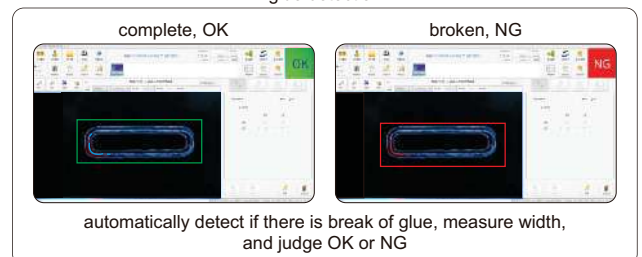

X-Y METAL STAGE CODE ISM-DL-STAGE1

- Suitable for digital microscopes
ISM-DL300, ISM-DL301, 5303-AF103

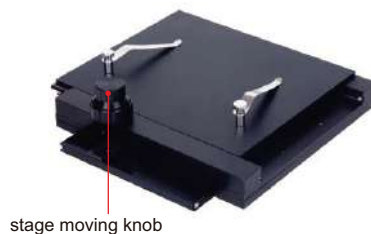

SPECIFICATION

X-Y travel range	100×86mm
Dimension (L×W×H)	180×180×50mm
Weight	2.3kg

DUAL HEAD LED ILLUMINATION CODE ISM-ZS-LED

- Adjustable illumination
- For digital and stereo microscopes



application



SPECIFICATION

Power	3W
Power supply	100~240V
Working	10000h
Illumination	10000lux

LED AUXILIARY ILLUMINATION CODE ISM-DL-LED

- Suitable for digital microscopes
ISM-DL300, ISM-DL301, ISM-DL302,
ISM-DL400, 5303-AF103



illumination direction and brightness are adjustable

SPECIFICATION

Power	8W
Diameter of mounting hole	Ø25mm
Power supply	10~12V, 0~300mA

COAXIAL LIGHT ILLUMINATION CODE ISM-DL-COAXIAL

- Suitable for digital microscopes
5303-AF103, ISM-DL300,
ISM-DL301, ISM-DL400



for smooth surfaces and small holes,
brightness is adjustable

SPECIFICATION

Power	1W
Power supply	0~3.4V, 0~400mA

ATTENTION: PLEASE MAKE CONFOCAL ADJUSTMENT AFTER CHANGING CAMERA ADAPTERS OR AUXILIARY OBJECTIVES

AUXILIARY OBJECTIVES

MAGNIFICATION, FOCUS DISTANCE AND VIEW FIELD (5303-AF103)

Auxiliary objective	Specification	Camera adapter	
		0.5X (included)	1X (optional)
0.3X (optional)	Magnification	6~37X	12~74X
	Focus distance	120~310mm	120~310mm
	View field	52×30~8×5mm	26×15~4×2.5mm
0.5X (optional)	Magnification	10~61X	20~123X
	Focus distance	78~230mm	78~230mm
	View field	37×20~5×3mm	18×10~2.5×1.5mm
0.75X (optional)	Magnification	15~92X	30~184X
	Focus distance	60~125mm	60~125mm
	View field	21×13~3.4×2mm	10×6.5~1.7×1mm
1X (included)	Magnification	20~123X	40~246X
	Focus distance	48~84mm	48~84mm
	View field	15×8~2.5×1.5mm	7.5×4~1.3×0.7mm
1.5X (optional)	Magnification	30~184X	60~368X
	Focus distance	36~63mm	36~63mm
	View field	10×6~1.7×1mm	5×3~0.9×0.5mm
2X (optional)	Magnification	40~246X	80~492X
	Focus distance	24~42mm	24~42mm
	View field	7.5×4~1.3×0.7mm	3.8×2~0.7×0.4mm



0.3X auxiliary objective
ISM-DL-OB03X



0.5X auxiliary objective
ISM-DL-OB05X



0.75X auxiliary objective
ISM-DL-OB075X



1X auxiliary objective
ISM-DL-OB1X



1.5X auxiliary objective
ISM-DL-OB1D5X



2X auxiliary objective
ISM-DL-OB2X

- Suitable for digital microscopes 5303-AF103,
ISM-DL300, ISM-DL301, ISM-DL400

MAGNIFICATION, FOCUS DISTANCE AND VIEW FIELD (ISM-DL300, ISM-DL301)

Auxiliary objective	Specification	Camera adapter	
		0.5X (included)	1X (optional)
0.3X* (optional)	Magnification	5~34X	10~68X
	Focus distance	287±2mm	287±2mm
	View field	42×26~6.5×4.5mm	21×13~3.3×2.3mm
0.5X* (optional)	Magnification	9~56X	18~112X
	Focus distance	166±2mm	166±2mm
	View field	25.6×16.8~5×3.5mm	12.8×8.4~2×1.3mm
0.75X* (optional)	Magnification	13~84X	26~168X
	Focus distance	105±2mm	105±2mm
	View field	17×10.5~2.6×1.7mm	8.5×5.3~1.3×0.9mm
1X (included)	Magnification	15~100X	30~200X
	Focus distance	70±2mm	70±2mm
	View field	16×11~2.5×1.6mm	7.8×5.3~1.2×0.8mm
1.5X (optional)	Magnification	26~168X	52~336X
	Focus distance	42±2mm	42±2mm
	View field	8.5×5.2~1.3×0.9mm	4.3×2.6~0.7×0.5mm
2X (optional)	Magnification	30~200X	60~400X
	Focus distance	29±2mm	29±2mm
	View field	7.8×5.3~1.2×0.8mm	3.8×2.7~0.6×0.4mm

* For auxiliary objectives 0.3X, 0.5X, 0.75X, use contour illumination of ISM-DL301 or LED auxiliary illumination (code ISM-DL-LED)

DIGITAL MEASURING MICROSCOPES

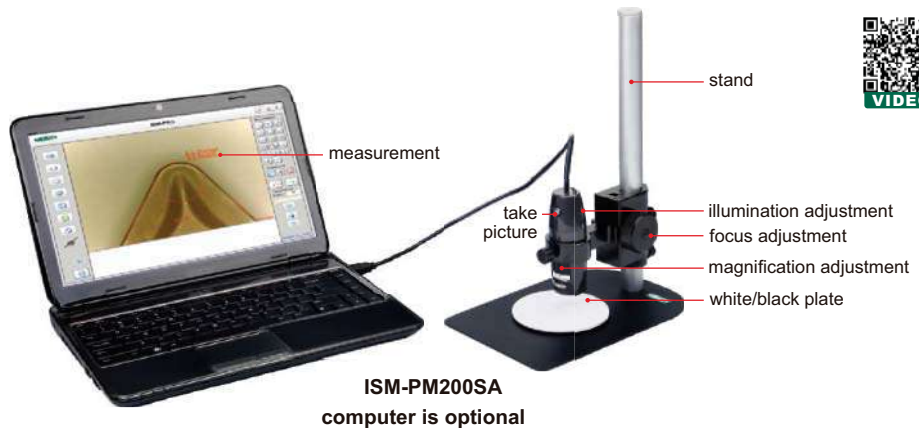

- Can take pictures and videos
- Supplied with software

SPECIFICATION

Code	ISM-PM200SA	ISM-PM200SB	ISM-PM600SA	ISM-PM160LA
Magnification	10X~200X	10X~200X	450X~600X	35X~160X
Focus distance	short focus distance	short focus distance	short focus distance	long focus distance
Stand	standard	universal	standard	standard
Focus support	included	included	not included	not included
Calibration rule	graduation 0.1 and 1mm	graduation 0.1 and 1mm	graduation 0.1mm	graduation 0.1 and 1mm
Pixel	2M (resolution: 1600×1200)			
Illumination	built-in adjustable LED			
Power supply	USB 2.0 cable (voltage required: 5±0.1V)			

OPTIONAL ACCESSORY

Green filter	ISM-PM-GREEN
Yellow filter	ISM-PM-YELLOW
Blue filter	ISM-PM-BLUE



universal stand (included in ISM-PM200SB)



MAGNIFICATION, FOCUS DISTANCE, VIEW FIELD AND ACCURACY

ISM-PM200SA/ISM-PM200SB			
Magnification	Focus distance	View field	Accuracy
50X	21mm	8.1×6.4mm	30μm
100X	13mm	3.9×3.1mm	15μm
150X	16mm	2.6×2.1mm	10μm
200X	19mm	1.8×1.5mm	8μm

ISM-PM600SA			
Magnification	Focus distance	View field	Accuracy
450X	1.4mm	0.85×0.67mm	6μm
500X	5.5mm	0.76×0.61mm	6μm
550X	8.6mm	0.69×0.55mm	5μm
600X	11.5mm	0.63×0.51mm	5μm

ISM-PM160LA			
Magnification	Focus distance	View field	Accuracy
50X	62mm	8.1×6.4mm	30μm
100X	45mm	3.9×3.1mm	15μm
160X	50mm	2.4×1.9mm	10μm

SOFTWARE

- **Language:** English, Japanese, Korean, German, Turkey, Portuguese, Chinese
- **Operation system:** Windows 7/8/XP/Vista

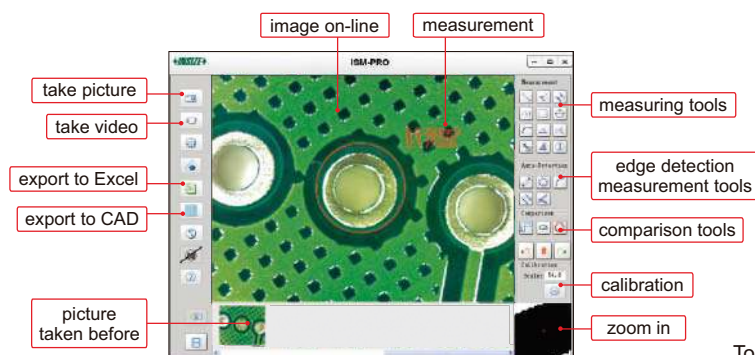

To be continued

Continued from previous page

■ **Measuring tools:**

- measure length of line or distance between two points
- measure area of rectangle
- measure angle with two lines
- measure distance between two circles
- measure distance between point and line
- measure radius, length and angle of arc
- measure radius, girth and area of circle
- add number with circle
- measure length of continuous line
- measure distance between two parallel lines
- measure angle with three points
- add text

■ **Edge detection measurement tools:**

- detect two parallel lines automatically and calculate distance
- detect circle automatically, and calculate radius, girth and area
- detect arc automatically, and calculate radius, angle and arc length
- detect two lines automatically, and calculate angle
- detect line automatically, and calculate length

■ **Comparison tools:**

Create line, angle or circle with desired size, to compare with workpieces

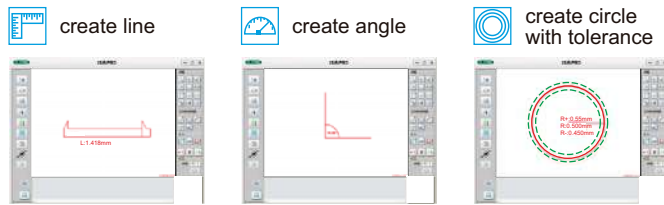

■ **Data export to CAD or Excel:**

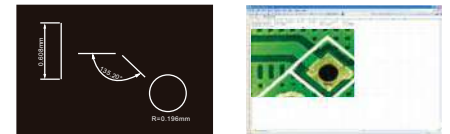

ATTENTION: NOT FOR MEASUREMENT, NOT SUITABLE FOR COMPUTERS

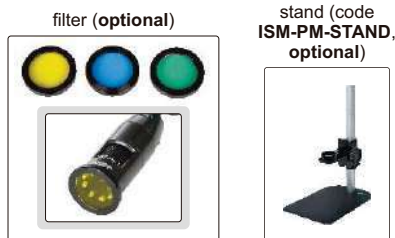

- Connected to TV directly
- For observation, cannot take pictures and videos

SPECIFICATION

Code	ISM-TV200	ISM-TV200W
Type	with wire	wireless (maximum transmission distance 5m)
Magnification	10X~200X (on 17" TV)	
Pixel	0.35M	
Illumination	adjustable brightness LED	
Focus	supplied with focus ring, stand (ISM-PM-STAND) is optional	
Power supply	DC	built-in rechargeable battery



ISM-TV200 (with wire)



ISM-TV200W (wireless)

TV DIGITAL MICROSCOPES



OPTIONAL ACCESSORY

Stand	ISM-PM-STAND
Green filter	ISM-PM-GREEN
Yellow filter	ISM-PM-YELLOW
Blue filter	ISM-PM-BLUE

MAGNIFICATION, FOCUS DISTANCE AND VIEW FIELD

ISM-TV200			ISM-TV200W		
Magnification	Focus distance	View field	Magnification	Focus distance	View field
50X	21mm	8.1×6.4mm	60X	19mm	6.9×5.2mm
100X	13mm	3.9×3.1mm	80X	16mm	5.0×3.8mm
150X	16mm	2.6×2.1mm	150X	16mm	2.6×2.1mm
200X	19mm	1.8×1.5mm	200X	19mm	1.8×1.5mm

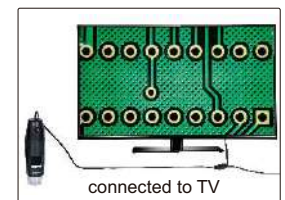

WiFi DIGITAL MEASURING MICROSCOPE CODE ISM-WF200

- Maximum working distance is 5m under WiFi mode
- Can be connected to multiple iPads, Android devices or computers together under WiFi mode
- Take pictures and videos
- Supplied with software



stand (code ISM-PM-STAND, optional)

software CD (included)



filter (optional)

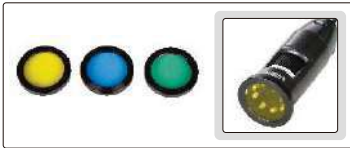

plastic calibration rule (graduation 1mm, included)

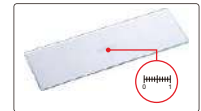

glass calibration rule (graduation 0.1mm, included)

SPECIFICATION

Magnification	10X~200X
Pixel	1.3M (resolution: 1280×1024)
Illumination	built-in adjustable LED
Power supply	built-in rechargeable battery



STANDARD DELIVERY

Microscope	1 pc
Focus support ring for 80X/150X	1 pc
Focus support ring for 60X/200X	1 pc
Glass calibration rule (graduation 0.1mm)	1 pc
Plastic calibration rule (graduation 1mm)	1 pc
USB cable and software	1 pc
AC/DC adapter	1 pc



OPTIONAL ACCESSORY

Stand	ISM-PM-STAND
Green filter	ISM-PM-GREEN
Yellow filter	ISM-PM-YELLOW
Blue filter	ISM-PM-BLUE

MAGNIFICATION, FOCUS DISTANCE, VIEW FIELD AND ACCURACY

Magnification	Focus distance	View field	Accuracy
50X	21mm	8.1×6.4mm	30μm
100X	13mm	3.9×3.1mm	15μm
150X	16mm	2.6×2.1mm	10μm
200X	19mm	1.8×1.5mm	8μm

1 Software ISM-PAD (for iPad by WiFi)

- measure length of line or distance between two points
- measure angle
- measure radius, girth and area of circle with three points

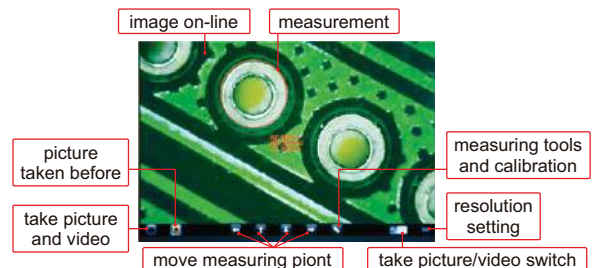

To be continued

Continued from previous page

2 Software ISM-APK (for Android devices by WiFi)

- measure length of line or distance between two points
- measure radius, girth and area of circle with three points
- measure angle

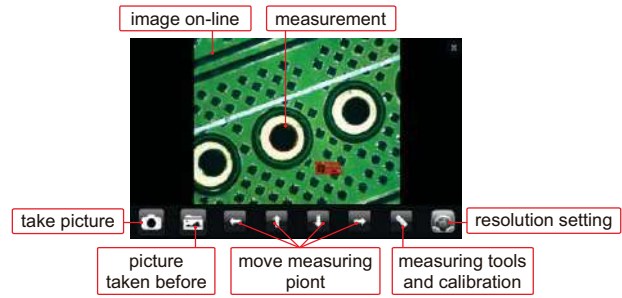

3 Software ISM-WF Partner (for computer by WiFi)

- | | |
|--|--|
| measure length of line or distance between two points | measure angle with two lines |
| measure area of polygon | measure radius, girth and area of circle with two points |
| measure angle with three points | measure distance between point and line |
| measure radius, girth and area of circle with center point | measure radius, length and angle of arc |
| measure length of continuous line | measure area of rectangle |
| measure radius, girth and area of circle with three points | |

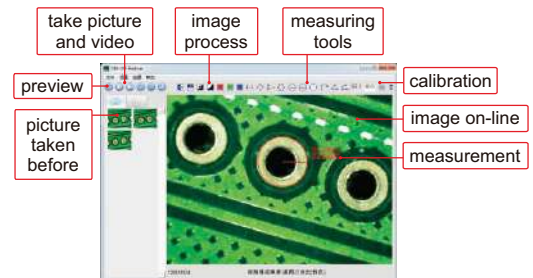

4 Software ISM-PRO (for computer by USB cable)

Measuring tools:

- | | |
|---|---|
| measure length of line or distance between two points | measure distance between point and line |
| measure length of continuous line | measure area of rectangle |
| measure radius, length and angle of arc | measure angle with two lines |
| measure distance between two circles | add number with circle |
| measure distance between two parallel lines | measure angle with three points |
| measure radius, girth and area of circle | add text |

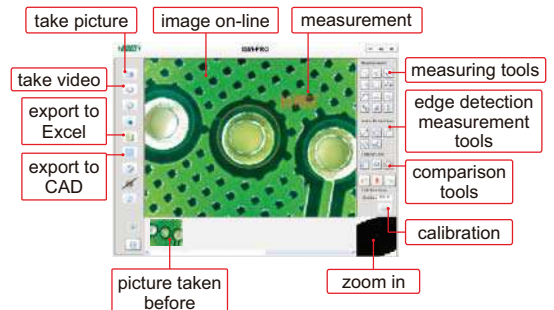

Edge detection measurement tools:

- | | |
|--|--|
| detect line automatically, and calculate length | detect two lines automatically, and calculate angle |
| detect arc automatically, and calculate radius, angle and arc length | detect two parallel lines automatically and calculate distance |
| detect circle automatically, and calculate radius, girth and area | |

Comparison tools:

Create line, angle or circle with desired size, to compare with workpieces

- | | | |
|-------------|--------------|------------------------------|
| create line | create angle | create circle with tolerance |
|-------------|--------------|------------------------------|

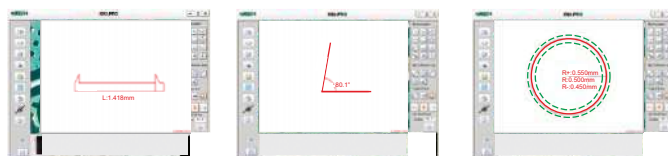

Data export to CAD or Excel:



INDUSTRIAL MICROSCOPES



5101-M500

- Infinite optical system, polarization observation, dark field observation
- Kohler illumination system provides uniform illumination field
- Objective 50X is spring type

SPECIFICATION

Code	5101-M500** (bright field objectives)				5101-M500BD** (bright & dark field objectives)			
Illumination	6V/30W halogen lamp, brightness is adjustable				12V/50W halogen lamp, brightness is adjustable			
Objective (infinite plan achromatic)	bright field objectives				bright & dark field objectives			
	5X	10X	20X	50X	5X	10X	20X	50X
Working distance	26.1mm	20.2mm	8.80mm	3.68mm	9.70mm	9.30mm	7.23mm	2.50mm
Numerical aperture	0.12	0.25	0.40	0.70	0.12	0.25	0.40	0.70
Magnification	50X~500X							
Eyepiece (wide field)	10X (view field: Ø22mm)							
Stage	double layer							
	size: 160×140mm							
	travel: 35×30mm							
Pupil distance	53~75mm							
Diopter adjustment	±5 diopter (one eyepiece)							
Power supply	220V, 50/60Hz **							
Dimension (L×W×H)	415×345×380mm							
Weight	14kg							

** Add "-U" on code No. when power supply is 110V, 50/60Hz

STANDARD DELIVERY

Main unit	1 pc
Anti-dust cover	1 pc

OPTIONAL ACCESSORY

Bright & dark field objective (for 5101-M500BD)	PL40X	5101-M-BD40X
	PL60X	5101-M-BD60X
	PL80X	5101-M-BD80X
	PL100X	5101-M-BD100X
10X dividing eyepiece (0.1mm/div.)		5101-M-EPD10X

Bright field objective (for 5101-M500)	PL40X	5101-M-OB40X
	PL60X	5101-M-OB60X
	PL80X	5101-M-OB80X
	PL100X	5101-M-OB100X
Digital camera		ISM-CM20, ISM-CM63, ISM-ZS70-S
Camera adapter *		5101-M-ADAPTER

* Digital camera must be used with camera adapter

INDUSTRIAL INSPECTION MICROSCOPE (LARGE STAGE) CODE 5104-M700**



- For observation and inspection of large IC and chip in IT industry

SPECIFICATION

Magnification	40X~400X			
Eyepiece (wide field)	10X (view field: Ø22mm)			
Objective (plan achromatic)	4X	10X	20X	40X
Numerical aperture	0.10	0.25	0.40	0.60
Working distance	17.8mm	10mm	5.8mm	2.9mm
Stage	double layer, size: 300×268mm, travel: 250×200mm			
Kohler illumination	6V/20W halogen lamp, brightness is adjustable built-in green, blue, yellow and frosted glasses			
Pupil distance	48~75mm			
Diopter adjustment	±5 diopter (two eyepieces)			
Power supply	220V, 50/60Hz **			
Dimension (L×W×H)	647×268×376mm			
Weight	12kg			

** Add "-U" on code No. when power supply is 110V, 50/60Hz

STANDARD DELIVERY

Main unit	1 pc
Camera connector	1 pc
Anti-dust cover	1 pc

OPTIONAL ACCESSORY

Bright field objective	2.5X plan achromatic objective (focus distance: 11.7mm)	5104-M700-OB2.5X
	5X plan achromatic objective (focus distance: 15.5mm)	5104-M700-OB5X
	50X plan achromatic objective (focus distance: 0.32mm)	5104-M700-OB50X
	100X plan achromatic objective (focus distance: 2mm)	5104-M700-OB100X
Polarizer and analyzer		5104-M700-AP
Digital camera		ISM-CM20, ISM-CM63, ISM-ZS70-S
Camera adapter 0.5X*		ISM-MAS-ADAPTER

* Digital camera must be used with camera adapter

METALLURGICAL MICROSCOPES



5102-M600

- Infinite optical system, observation in reflected or transmitted illumination, polarizing observation
- Kohler illumination system provides uniform illumination field
- Objectives 40X, 60X are spring type

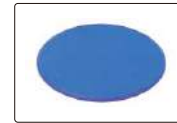

blue filter (included)



frosted glass filter (included)

SPECIFICATION

Code	5102-M600** (bright field objectives)				5102-M600BD** (bright & dark field objectives)			
illumination	6V/30W (transmitted)		6V/30W (reflected)		12V/30W (transmitted)		12V/50W (reflected)	
Objective (infinite plan achromatic)	bright field objectives				bright & dark field objectives			
	5X	10X	40X	60X	5X	10X	20X	40X
Working distance	26.1mm	20.2mm	3.98mm	3.18mm	9.70mm	9.30mm	7.20mm	3.00mm
Numerical aperture	0.12	0.25	0.60	0.70	0.12	0.25	0.40	0.70
Magnification	50X~600X				50X~400X			
Eyepiece (wide field)	10X (view field: Ø22mm)							
Stage	double layer							
	size: 210×140mm							
	travel: 75×50mm							
Pupil distance	53~75mm							
Diopter adjustment	±5 diopter (one eyepiece)							
Power supply	220V, 50/60Hz **							
Dimension (L×W×H)	456×260×498mm							
Weight	11kg							

** Add "-U" on code No. when power supply is 110V, 50/60Hz

STANDARD DELIVERY

Main unit	1 pc
Anti-dust cover	1 pc
Filter (blue/frosted glass)	1 pc of each

OPTIONAL ACCESSORY

Bright & dark field objective (for 5102-M600BD)	PL50X	5101-M-BD50X
	PL60X	5101-M-BD60X
	PL80X	5101-M-BD80X
	PL100X	5101-M-BD100X
10X dividing eyepiece (0.1mm/div.)	5101-M-EPD10X	

Bright field objective (for 5102-M600)	PL20X	5101-M-OB20X
	PL50X	5101-M-OB50X
	PL80X	5101-M-OB80X
	PL100X	5101-M-OB100X
Digital camera	ISM-CM20, ISM-CM63, ISM-ZS70-S	
Camera adapter *	5101-M-ADAPTER	

* Digital camera must be used with camera adapter

METALLURGICAL MICROSCOPES



- Infinite optical system, polarization observation
- Kohler illumination system provides uniform illumination field
- Objectives 50X, 100X are spring type

SPECIFICATION

Code	5103-M1000** (bright field objectives)				5103-M1000BD** (bright & dark field objectives)			
Illumination	6V/30W halogen lamp, brightness is adjustable				12V/50W halogen lamp, brightness is adjustable			
Objective (infinite plan achromatic)	bright field objectives				bright & dark field objectives			
	10X	20X	50X	100X	5X	10X	20X	50X
Working distance	20.2mm	8.80mm	3.68mm	0.40mm	9.70mm	9.30mm	7.23mm	2.50mm
Numerical aperture	0.25	0.40	0.70	0.85	0.12	0.25	0.40	0.70
Magnification	100X~1000X				50X~500X			
Eyepiece (wide field)	10X (view field: Ø22mm)							
Stage	double layer							
	size: 242×200mm							
	travel: 30×30mm							
Pupil distance	53~75mm							
Diopter adjustment	±5 diopter (one eyepiece)							
Power supply	220V, 50/60Hz **							
Dimension (L×W×H)	614×250×394mm							
Weight	13kg							

** Add "-U" on code No. when power supply is 110V, 50/60Hz

STANDARD DELIVERY

Main unit	1 pc
Polarizer and analyzer	1 pc of each
Anti-dust cover	1 pc

OPTIONAL ACCESSORY

Bright & dark field objective (for 5103-M1000BD)	PL40X	5101-M-BD40X
	PL60X	5101-M-BD60X
	PL80X	5101-M-BD80X
	PL100X	5101-M-BD100X
10X dividing eyepiece (0.1mm/div.)	5103-M-EPD10X	

Bright field objective (for 5103-M1000)	PL5X	5101-M-OB5X
	PL40X	5101-M-OB40X
	PL60X	5101-M-OB60X
	PL80X	5101-M-OB80X
Digital camera	ISM-CM63	
Camera adapter *	5101-M-ADAPTER	

* Digital camera must be used with camera adapter

PARALLEL LIGHT STEREO MICROSCOPE CODE ISM-ZS200

PARALLEL LIGHT PATH: REDUCE FATIGUE,
ACCESSORIES CAN BE ADDED INTO LIGHT PATH



coaxial illumination (optional)



optical path splitter (optional)



iris diaphragm (optional)



- Infinity parallel optical system and 20° inclined optical tube reduce fatigue
- Coaxial illumination is optional for deep holes which cannot be observed by ring light
- Aperture diaphragm is optional for large depth of field and high quality image

SPECIFICATION

Optical tube	binocular (20° inclined)
Eyepiece (wide field)	10X (view field: Ø22mm)
Objective	0.8X~8X (zoom)
Zoom ratio	1:10
Pupil distance	55~75mm
Diopter adjustment	±5 diopter (both eyepieces)
Working distance of objective	78mm
Max. workpiece height	72mm
Illumination	adjustable reflected and transmitted LED light
Power supply	110/220V, 50/60HZ
Dimension (L×W×H)	240×280×440mm
Weight	4.3kg

STANDARD DELIVERY

Main unit	1 pc
WF 10X eyepiece	2 pcs
Ø100mm glass plate	1 pc
Ø100mm white/black plate	1 pc
Anti-dust cover	1 pc

OPTIONAL ACCESSORY

Objective	0.5X achromatic objective (focus distance: 186mm)	ISM-ZS200-OB05X *
	2X plan achromatic objective (focus distance: 32.5mm)	ISM-ZS200-OB2X
	0.5X plan apochromatic objective (focus distance: 126mm)	ISM-ZS200-APO05X *
Eyepiece	WF15X (view field: Ø16mm)	ISM-ZS200-EP15X
	WF20X (view field: Ø12mm)	ISM-ZS200-EP20X
	WF30X (view field: Ø20mm)	ISM-ZS200-EP30X
Sleeve for objective		ISM-ZS30-ADAPTER
Iris diaphragm		ISM-ZS200-IRD
Optical path splitter		ISM-ZS200-OBS
Coaxial illumination		ISM-ZS200-COAXIAL
Digital camera **		ISM-CM20, ISM-CM63

*0.5X achromatic objective must be used with sleeve ISM-ZS30-ADAPTER

**Digital camera must be used with optical path splitter

LARGE ZOOM RATIO

ZOOM STEREO MICROSCOPES (ADVANCED TYPE)

application
(code: **ISM-ZS100T**)

connect to
digital camera



LED ring light (optional)



VIDEO

ISM-ZS100T

SPECIFICATION

Code	ISM-ZS100	ISM-ZS100T
Optical tube	binocular	trinocular
Eyepiece (wide field)	10X (view field: Ø23mm)	
Objective	0.6X~5X (zoom)	
Zoom ratio	1:8.3	
Pupil distance	55~75mm	
Diopter adjustment	±5 diopter (two eyepieces)	
Working distance of objective	115mm	
Max. workpiece height	75mm	
Illumination	adjustable reflected and transmitted LED light	
Power supply	110/220V, 50/60HZ	
Dimension (L×W×H)	260×310×490mm	
Weight	4.9kg	

STANDARD DELIVERY

Main unit	1 pc
Digital camera adapter 0.55X for ISM-ZS100T	1 pc
WF10X eyepiece	2 pcs
Ø100mm glass plate	1 pc
Ø100mm white/black plate	1 pc
Anti-dust cover	1 pc

OPTIONAL ACCESSORY

Auxiliary objective	0.5X (focus distance: 220mm)	ISM-ZS100-OB05X *
	0.7X (focus distance: 125mm)	ISM-ZS100-OB07X
	2X (focus distance: 45mm)	ISM-ZS100-OB2X
Eyepiece	WF15X (view field: Ø16mm)	ISM-ZS100-EP15X
	WF20X (view field: Ø12mm)	ISM-ZS100-EP20X
	WF30X (view field: Ø8mm)	ISM-ZS100-EP30X
Sleeve for auxiliary objective		ISM-ZS30-ADAPTER
LED ring light		ISM-ZS-RL
Digital camera adapter 1X for ISM-ZS100T		ISM-ZS100-DA
Digital camera for ISM-ZS100T		ISM-CM20, ISM-CM63, ISM-ZS70-S

*0.5X auxiliary objective must be used with sleeve ISM-ZS30-ADAPTER

ZOOM STEREO MICROSCOPES (STANDARD TYPE)



LED ring light (optional)



ISM-ZS50

SPECIFICATION

Code	ISM-ZS50	ISM-ZS50T
Optical tube	binocular	trinocular
Eyepiece (wide field)	10X (view field: Ø22mm)	
Objective	0.8X~5X (zoom)	
Zoom ratio	1:6.3	
Pupil distance	55~75mm (adjustable)	
Diopter adjustment	±5 diopter (two eyepieces)	
Working distance of objective	115mm	
Max. workpiece height	215mm	
Illumination	adjustable reflected and transmitted LED light	
Power supply	110/220V, 50/60HZ	
Dimension (L×W×H)	290×260×480mm	
Weight	4.9kg	

STANDARD DELIVERY

Main unit	1 pc
WF 10X eyepiece	2 pcs
Ø100mm glass plate	1 pc
Ø100mm white/black plate	1 pc
Anti-dust cover	1 pc

OPTIONAL ACCESSORY

Auxiliary objective	0.5X	ISM-ZS50-OB05X*
	2X	ISM-ZS50-OB2X
Eyepiece	10X dividing eyepiece (graduation 0.1mm/div.)	ISM-ZS50-EPD10X
	WF15X (view field: Ø16mm)	ISM-ZS50-EP15X
	WF20X (view field: Ø12mm)	ISM-ZS50-EP20X
LED ring light		ISM-ZS-RL
Sleeve for auxiliary objective		ISM-ZS30-ADAPTER
Digital camera for ISM-ZS50T		ISM-CM20, ISM-CM63, ISM-ZS70-S
Camera adapter 0.5X for ISM-ZS50T**		ISM-MAS-ADAPTER

* 0.5X auxiliary objective must be used with ISM-ZS30-ADAPTER

** Digital camera must be used with camera adapter 0.5X



VIDEO

ZOOM STEREO MICROSCOPE (BASIC TYPE) CODE ISM-ZS30

SPECIFICATION

Optical tube	binocular
Eyepiece (wide field)	10X (view field: Ø20mm)
Objective	1X~4.5X (zoom)
Zoom ratio	1:4.5
Pupil distance	55~75mm (adjustable)
Diopter adjustment	±5 diopter (two eyepieces)
Working distance of objective	97mm
Max. workpiece height	147mm
Illumination	adjustable reflected and transmitted LED light
Power supply	110/220V, 50/60HZ
Dimension (L×W×H)	260×190×400mm
Weight	4.3kg

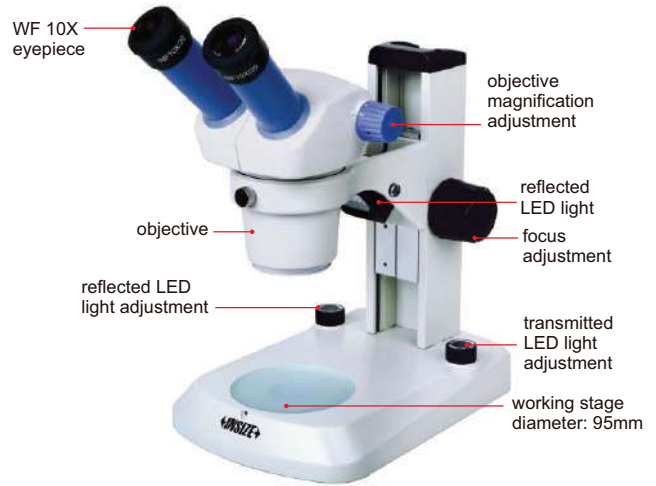

LED ring light (optional)

STANDARD DELIVERY

Main unit	1 pc
WF 10X eyepiece	2 pcs
Ø95mm glass plate	1 pc
Ø95mm white/black plate	1 pc
Anti-dust cover	1 pc

OPTIONAL ACCESSORY

Auxiliary objective	0.5X	ISM-ZS30-OB05X *
	0.63X	ISM-ZS30-OB06X *
	0.75X	ISM-ZS30-OB07X *
	2X	ISM-ZS30-OB2X
Eyepiece	10X dividing eyepiece (graduation 0.1mm/div.)	ISM-ZS30-EPD10X
	WF15X (view field: Ø16mm)	ISM-ZS50-EP15X
	WF20X (view field: Ø12mm)	ISM-ZS50-EP20X
LED ring light		ISM-ZS-RL
Sleeve for auxiliary objective		ISM-ZS30-ADAPTER
Digital camera		ISM-CM63
Camera adapter 0.75X **		ISM-AD-0D75

* 0.5X, 0.63X and 0.75X auxiliary objectives must be used with ISM-ZS30-ADAPTER

** Digital camera must be used with camera adapter 0.75X

LONG WORKING DISTANCE STEREO MICROSCOPE (LOW MAGNIFICATION) CODE 5305-ZS80

17

SPECIFICATION

Magnification	8X
Eyepiece (wide field)	10X (view field: Ø20mm)
Objective	0.8X
Pupil distance	55~75mm
Diopter adjustment	±5 diopter (one eyepiece)
Working distance of objective	115mm
Max. workpiece height	100mm
Dimension (L×W×H)	280x160x370mm
Weight	3.7kg

STANDARD DELIVERY

Main unit	1 pc
10X eyepieces	1 pair
0.8X objective	1 pc
Anti-dust cover	1 pc

OPTIONAL ACCESSORY

Eyepiece	WF5X (view field: Ø20mm)	5305-ZS80-EP5X
	WF15X (view field: Ø15mm)	5305-ZS80-EP15X
	WF20X (view field: Ø10mm)	5305-ZS80-EP20X
LED ring light		ISM-ZS-RL



LED ring light (optional)



VIDEO

POLARIZING MICROSCOPE CODE ISM-POL1000



- Widely used in geology, mineralogy, fossil fuel exploration
- Single polarization, orthogonal polarization or conoscopic observation are available



SPECIFICATION

Magnification	40X~600X				
Eyepiece	10X (view field: \varnothing 20mm)				
Infinite strain free plan achromatic objective	4X (transmitted/reflected)	10X (transmitted/reflected)	20X (transmitted)	40X (transmitted)	60X (transmitted)
Working distance	22.2mm	6.1mm	6.4mm	0.6mm	0.3mm
Numerical aperture	0.1	0.25	0.4	0.65	0.8
Stage	revolving round stage diameter: \varnothing 160mm graduation: 1°, resolution: 6'				
Pupil distance	53~75mm				
Diopter adjustment	\pm 5 diopter (one eyepiece)				
Illumination	12V/50W halogen lamp, brightness is adjustable (reflected illumination) 12V/20W halogen lamp, brightness is adjustable (transmitted illumination)				
Power supply	110/220V, 50/60HZ				
Dimension (L×W×H)	614×250×394mm				
Weight	13kg				

STANDARD DELIVERY

Main unit	1 pc
Micrometer	1 pc
Grid plate	1 pc
10X crossing eyepiece (view field: \varnothing 20mm)	1 pc
10X dividing eyepiece (view field: \varnothing 20mm, graduation 0.1mm)	1 pc
λ slip (first class red) and 1/4 λ slip	1 pc
Quartz wedge	1 pc

OPTIONAL ACCESSORY

Objective for reflected system	PL20X	ISM-POL1000-OBR20X
	PL40X	ISM-POL1000-OBR40X
	PL60X	ISM-POL1000-OBR60X
	PL100X	ISM-POL1000-OBR100X
Objective for transmitted system	PL100X	ISM-POL1000-OBT100X
Specimen presser		ISM-POL1000-SP

ATTENTION: CAMERA CONNECTOR AND ADAPTER ARE NEEDED ACCORDING TO MICROSCOPES

MEASUREMENT, TAKE PICTURES AND VIDEOS

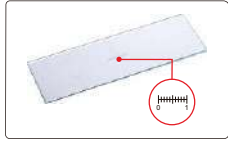

glass calibration rule (included, graduation 0.1mm)

- Windows 10 operation system
- 1080P high-definition image
- Take pictures and videos
- Measuring accuracy $\pm 0.01\text{mm}$
- Language: Chinese, English, Japanese, Korean, Russian
- Automatic white balance and exposure
- Brightness, contrast ratio, gain are adjustable

DIGITAL CAMERA FOR MICROSCOPES (WITH PAD) CODE ISM-ZS70-S

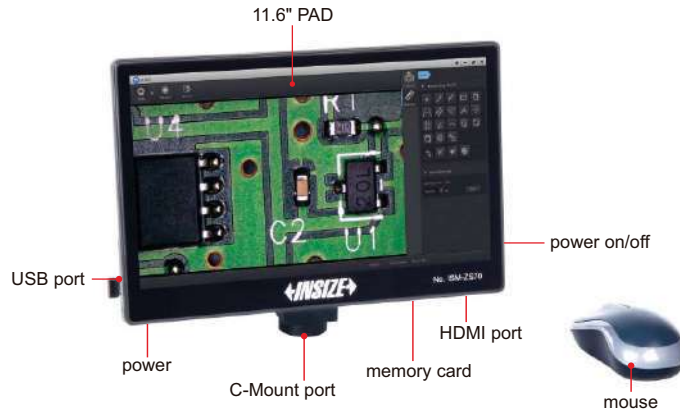

software (included)



Measuring tools

- measure length of line or distance between two points
- measure length of continuous line
- measure distance between point and line
- measure radius with three points
- measure distance between two parallel lines
- measure area of rectangle
- measure angle with three points
- measure radius of concentric circles
- measure distance between multiple parallel lines
- measure area of polygon
- measure length of arc
- measure distance between two circles

SPECIFICATION

Sensor	1/2.3" CMOS
Pixel	2M
Resolution	1024×768, 1280×720, 1280×1024, 1600×1200, 1920×1080
Frame rate	30fps (1920×1080)
Memory	4G
Output	HDMI/USB 2.0
Power supply	power adapter
Dimension (L×W×H)	280×53×253mm
Weight	1.5kg

STANDARD DELIVERY

Main unit	1 pc
Mouse	1 pc
Glass calibration rule (graduation 0.1mm)	1 pc
AC/DC adapter	1 pc

DIGITAL CAMERA FOR MICROSCOPES CODE ISM-CM20

ATTENTION: ADAPTERS ARE NEEDED
ACCORDING TO MICROSCOPES

FOCUS
STACKING

AUTOMATIC IMAGE
STITCHING

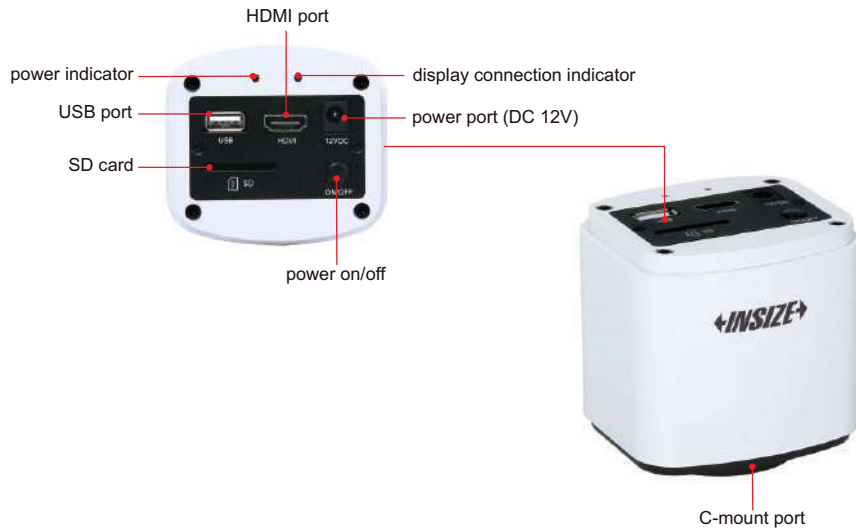

adapter 0.5X (optional)



- 1080P high-definition image
- Can be connected with displays or computers
- Built-in simple measuring software for displays, without computer
- Professional measuring software for computers is included
- For bright field, dark field or fluorescent field
- Automatic exposure, white balance, gain adjustment, gamma correction, brightness contrast adjustment, saturation adjustment, chroma sharpness adjustment
- Focus stacking, automatic image stitching

application



SIMPLE MEASURING SOFTWARE (BUILT-IN, FOR DISPLAYS)

Measuring tools:

- measure length of line or distance between two points
- measure distance between point and line
- measure rectangle
- measure concentric circles
- measure circle
- measure curve
- measure polygon
- measure center distance of two circles
- measure angle of two lines

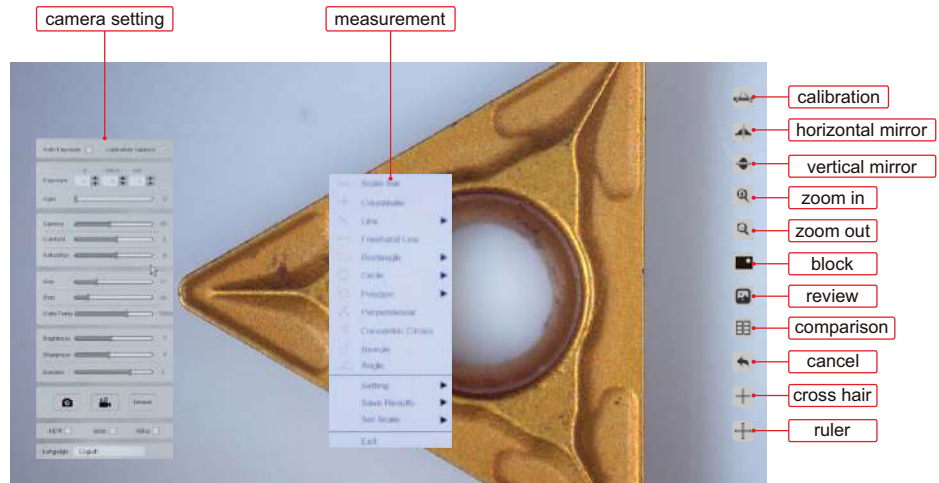

Auto exposure, white balance, gain adjustment, gamma, chroma contrast adjustment, brightness sharpness adjustment, size measurement

To be continued

continued from previous page

PROFESSIONAL MEASURING SOFTWARE (INCLUDED, FOR COMPUTERS)

selectable resolution

white balance
(balance color based on actual light source)

histogram
(quantify the distribution of color and brightness)

Image coloring, fluorescence synthesis, binary, image smoothing, color filter/color extraction/color inversion, delay capture, focus stacking, automatic image stitching, metrics flow, manual counting, dynamic and static measurement, layered measurement, report generation and printing, delay record, flat field correction, image adjustment, histogram.

flat field correction

metrics flow
(create templates, set tolerances and build metrics flow)

manual counting
(class counting)

focus stacking

+
→

focus on the top

focus on the bottom

clear image of both top and bottom

automatic image stitching

+
→

+
→

slowly move the workpiece to generate a stitched image automatically (this image can not be used for size measurement)

SPECIFICATION

Sensor	1/2.8" CMOS
Pixel	2M
Resolution	1920×1080
Frame rate	30fps
Power supply	power adapter
Output	HDMI/USB
Lens connection	C-mount

COMPUTER (optional) REQUIREMENT

Operation system	Windows 7/8/10 (64 bit)
CPU	Intel Core i5 or above
Memory	8GB or above
USB port	USB 3.0

DISPLAY (optional) REQUIREMENT

Size	13" or above
Resolution	1080P or above
HDMI port	TYPE A

STANDARD DELIVERY

Main unit	1 pc
16G memory card and holder	1 pc
Mouse	1 pc
HDMI cable	1 pc
USB cable	1 pc
Power supply	1 pc

OPTIONAL ACCESSORY

Adapter 0.5X	ISM-MAS-ADAPTER
--------------	-----------------

DIGITAL CAMERA FOR MICROSCOPES CODE ISM-CM63



**ATTENTION: ADAPTERS ARE NEEDED
ACCORDING TO MICROSCOPES**

- To be used with computers
- Sony Exmor back-illuminated CMOS sensor
- USB3.0 transfer
- Automatic exposure, gain adjustment, white balance, chrominance adjustment, saturation adjustment, gamma correction, luminance adjustment, contrast adjustment



C-mount port

application



adapter 0.75X (optional)



automatic image stitching (expand field of view)

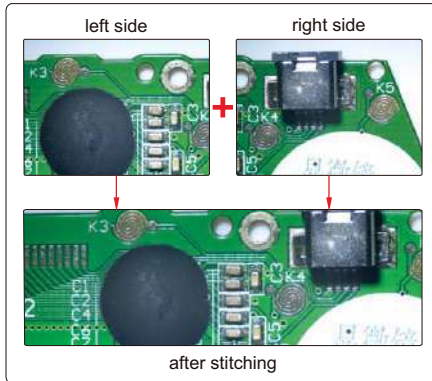

software (included)

selectable resolution

histogram (quantify the distribution of color and brightness)

measurement items

real time gray calibration

black balance (reduce color difference)

flat field correction (reduce brightness difference)

dark field correction (reduce thermal noise)

The software can control image completely, including measurement, image stitching, extend focus depth, image gray processing, RGB histogram observation, image color sampling, 3D plot (3D representation of image intensity), image exposure, white balance, black balance, image bit depth, flat field correction and dark field correction, etc.

counting

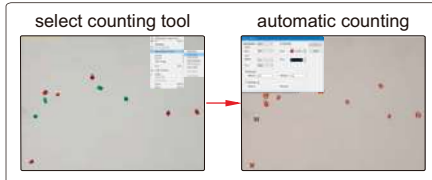

Measuring tools:

- | | | | |
|--|---|--|--|
| | measure length of line or distance between two points | | measure rectangle |
| | measure distance between two parallel lines | | measure width and diameter of ring |
| | measure angle | | measure diameter, length, perimeter angle of arc |
| | measure radius, girth and area of circle | | measure area of polygon |
| | measure axis lengths, girth and area of ellipse | | measure center distance between two circles |
| | calibration | | measure length of open curve |

focus stacking



Binary

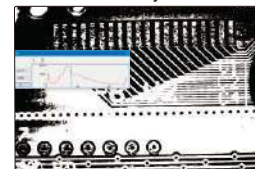

separate target and background

3D plot



Visualize the distribution of image brightness and color

To be continued



Continued from previous page

SPECIFICATION

Sensor (back-up)	1/1.8" CMOS
Resolution	6.3M
Pixel	3072×2048
Single pixel size	2.4×2.4μm
Spectral range	380-650nm (with infrared cut filter)
Frame rate	30fps
Sampling average	1×1
Exposure time	0.1ms~15s
Power supply	USB port
Weight	400g

STANDAER DELIVERY

Camera (USB cable included)	1 pc
Software	1 pc

COMPUTER REQUIREMENT

Operation system	Windows7/8/10
CPU	Intel Core 2 2.8Hz or above
Memery	2GB or above
USB port	USB3.0 (recommand) or USB2.0
Display	17" or above

OPTIONAL ACCESSORY

Adapter 0.75X	ISM-AD-0D75
---------------	-------------

SMART CAMERA CODE ISM-MV10



- Built-in software, operated by mouse.
- Automatically calculate, store the test results and export to Excel.
- Camera with PLC control input and output interface, can be integrated with automation equipment.
- Functions: presence or absence of objects, position tilt correction, object counting, color detection, stain detection, dimension measurement, position guide, etc.

SPECIFICATION

Chip structure	FPGA+ARM
Opreating system	Linux 3.10
Kernel structure	dual-core Cortex-A9
Frequency	1GHZ
I/O port	3 sets of input and output (can be connected to photoelectric switch, wire switch, PLC, etc.)
Working temperature	-10~70°C
Sensor	1/2" CMOS
Single pixel size	3.75×3.75μm
Resolution	1920×1080
Frame rate	60fps
Video output	HDMI port
Lens connection	standard C port

SOFTWARE

presence or absence of objects



select the area and specify the target, the camera will automatically detect the presence or absence of the target.

automatic counting

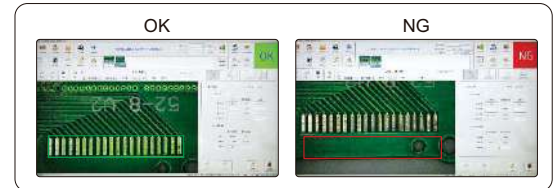

select the area and specify the target, the camera will automatically calculate the number of targets.

dimension measurement

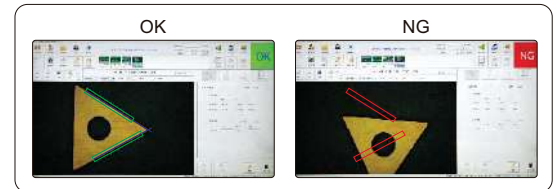

measuring angle, distance, radius, center distance, etc.

STANDAER DELIVERY

Camera (with HDMI cable)	1 pc
Software	1 pc

PORTABLE MEASURING MICROSCOPES



SPECIFICATION

Code	ISM-PM20	ISM-PM40	ISM-PM50	ISM-PM100
Total magnification	20X	40X	50X	100X
Eyepiece	10X with graduation	10X with graduation	10X with graduation	10X with graduation
Objective (achromatic)	2X (numerical aperture: 0.05)	4X (numerical aperture: 0.1)	5X (numerical aperture: 0.12)	10X (numerical aperture: 0.25)
Working distance	17.2mm	18mm	17.6mm	7mm
Graduation	0.05mm	0.025mm	0.02mm	0.01mm
Viewing field	Ø9mm	Ø4.5mm	Ø3.6mm	Ø1.8mm
Focus range	30mm			
Illumination	LED light			
Diameter of base	Ø63mm			
Height	210mm			
Weight	650g			

STANDARD DELIVERY

Main unit	1 pc
Pen light	1 pc
Battery (AAA)	2 pcs

TABLE MAGNIFIER WITH ILLUMINATION CODE 7517-3D

- Four steps brightness adjustment
- LED illumination, working life 20000h
- Resin lens

SPECIFICATION

Magnification	1.75X
Diopter	3D
Lens diameter	Ø125mm
Illumination	power: 3W, illumination: 260lm
Power supply	100~240V, 50~60Hz



7517-3D

17

18

TABLE MAGNIFIERS WITH ILLUMINATION

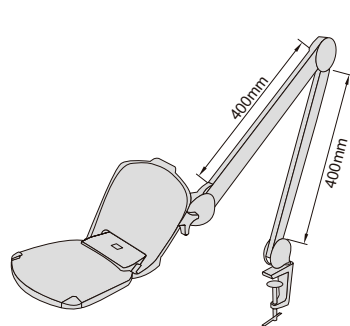

SPECIFICATION

Code	7520-320D	7521-3D
Magnification	two magnifications 1.75X/6X	1.75X
Diopter	3D/20D	3D
Lens dimension	160x127mm	Ø126mm
Illumination	power: 6W, illumination: 550lm	
Power supply	power adapter 12V, 1A	

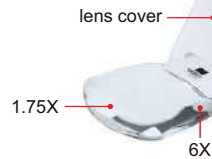

clamping holder
(clamping range
10~60mm)

7520-320D



clamping holder
(clamping range
10~60mm)

7521-3D

- LED illumination, working life 20000h
- Resin lens

TABLE MAGNIFIER WITH ILLUMINATION CODE 7516-5D

- LED illumination, working life 20000h

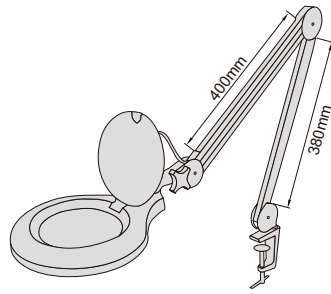

SPECIFICATION

Magnification	2.25X
Diopter	5D
Lens diameter	Ø122mm
Illumination	power: 7W, illumination: 420lm
Power supply	100~240V, 50~60Hz



7516-5D

FOLDING MAGNIFIER

- Glass lens

Code	Magnification	Lens diameter (ØD)
7511-8	10X	Ø21mm

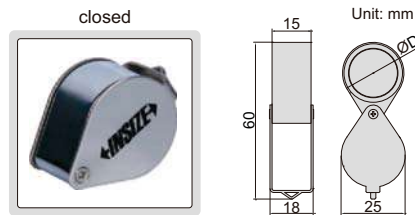

7511-8

FOLDING MAGNIFIER WITH ILLUMINATION



Code	Magnification	Lens diameter (ØD)
7515-10	10X	Ø21mm

- Resin lens
- Powered by 3xLR927 batteries (included)

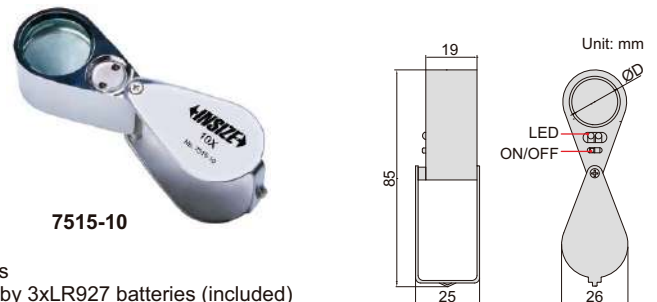

7515-10

FOLDING MAGNIFIER WITH ILLUMINATION

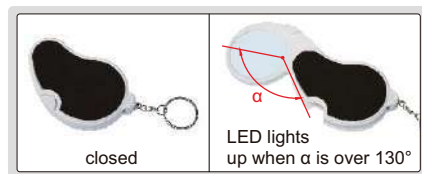

- Resin lens
- Powered by 2xCR1620 batteries (included)
- LED lights up automatically when α is over 130°

Code	Magnification	Lens diameter (ØD)
7514-1	2.5X	Ø45mm

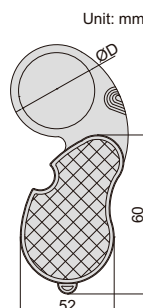

7514-1



MAGNIFIERS WITH ILLUMINATION

- Glass lens
- Powered by 3xAAA batteries (included)



7513-2

7513-4

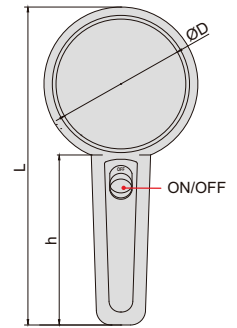

Code	Magnification	Lens diameter (ØD)	L	h
7513-2	2X	Ø75mm	170mm	90mm
7513-4	4X	Ø50mm	145mm	90mm

MAGNIFIER WITH TWO LENSES

2 pcs LED



- Resin lens
- Interchangeable lenses
- Powered by 3 pcs AAA batteries (included)



7522-610

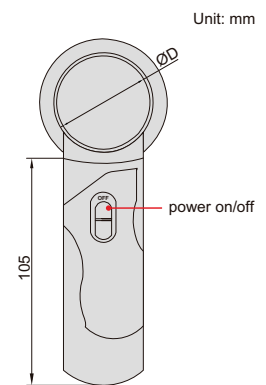

Code	Lens number	Magnification	Lens diameter (ØD)
7522-610	2 pcs	6X	37mm
		10X	50mm

MAGNIFIER WITH ILLUMINATION



- Two magnifications
- LED illumination
- Powered by 2 pcs AAA batteries (included)
- Resin lens



7518-26

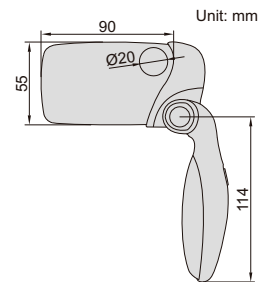

Code	Magnification	Lens size
7518-26	2X/6X	90x55mm

MAGNIFIER WITH ILLUMINATION

- Handheld and desk-type use
- Two magnifications
- LED illumination
- Powered by 2xAA batteries (included)
- Resin lens



7519-26

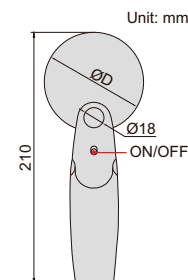

desk-type use



Code	Magnification	Lens diameter (ØD)
7519-26	2X/6X	90mm

THREE WAYS MAGNIFIER WITH ILLUMINATION

- Resin lens
- Powered by 2xAA batteries (included) or power adapter (110~240V, 50~60Hz)

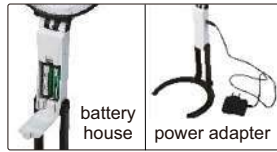

three ways use



10 pcs LED

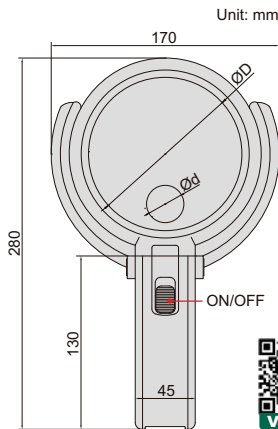

Code	Magnification	Lens diameter (ØD)	Lens diameter (Ød)
7512-1	2X/4X	Ø120mm	Ø28mm

MAGNIFICATION GLASSES

interchangeable lenses



head band (included)



7523-3D5

adjustable lens and LED angle

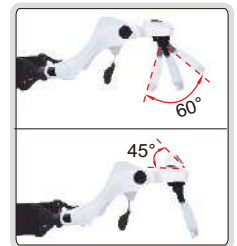

- Resin lens
- Interchangeable lenses
- Powered by 3 pcs AAA batteries (included)



Code	Lens number	Magnification
7523-3D5	5 pcs	1X
		1.5X
		2X
		2.5X
		3.5X

adjustable holder angle



moveable lens for focus



2 pcs LED



TELESCOPING INSPECTION MIRRORS

- Inspect hidden areas
- Rotation of the mirror: 360°
- Length of handle is adjustable, handle is made of brass and chrome plated

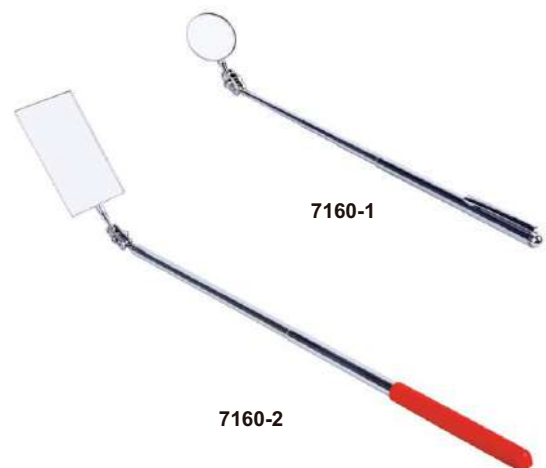
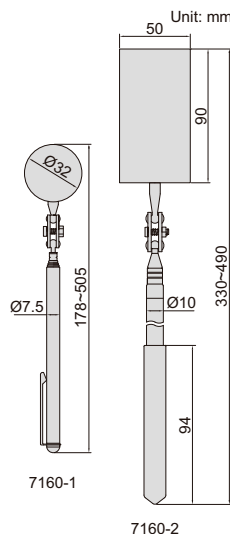

Code	Size of mirror	Length
7160-1	Ø32mm	178~505mm
7160-2	50x90mm	330~490mm

TELESCOPING INSPECTION MIRROR (WITH ILLUMINATION)

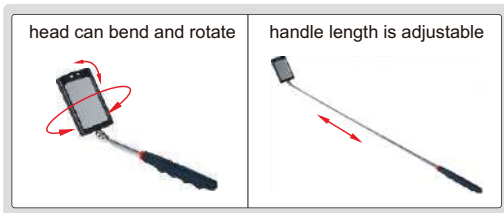

- Inspect hidden areas
- Head can bend and rotate
- Telescoping handle, made of stainless steel
- With two CR2032 batteries

Code	Size of mirror	Length
7162-1	65x42mm	285~875mm



7162-1

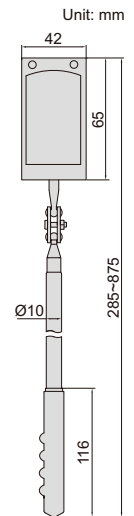

TELESCOPING MAGNETIC PICK-UP AND FLASHLIGHT



- For illumination and pick up steel parts in hidden areas
- Head can bend
- Telescoping handle, made of stainless steel
- Magnetic head and end
- With four LR44 batteries



7163-1



Code	Magnetic force of the end	Magnetic force of the head	Flashlight range	Battery life	Length
7163-1	4kgf	2kgf	3m	8h	172~568mm

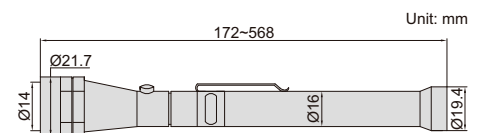

TELESCOPING MAGNETIC PICK-UP

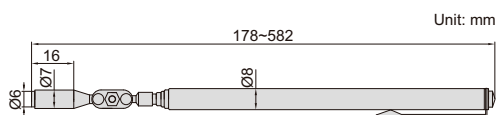

- Pick up steel parts from hidden areas
- Rotation of magnetic head: 360°
- Length of handle is adjustable, handle is made of brass and chrome plated



7161-1

Code	Size of magnetic tip	Magnetic force	Length
7161-1	Ø6mm	0.45kgf	178~582mm

FLEXIBLE PICK-UP AND FLASHLIGHT

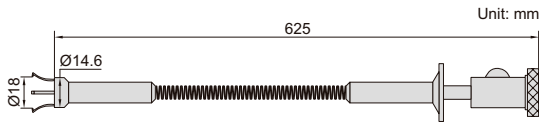

- To illumination, to pick up parts from hidden areas, or to pick up steel parts
- Flexible spring rod, made of stainless steel
- Three LR44 batteries

Code	Magnetic force	Flashlight range	Battery life
7164-1	0.9kgf	1m	24h

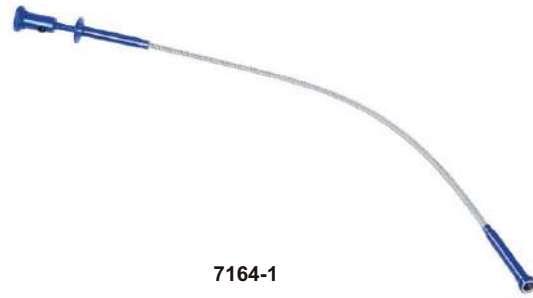

7164-1

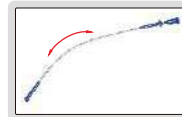

Flexible spring rod



Flashlight head



4 retractable claws



Magnetic head

IP64
WATERPROOF



HIGH-DEFINITION VIDEOSCOPE

MAIN UNIT (WITHOUT CABLE)

Code	ISV-MSU
Function	take picture, take video
File format	picture: JPG (resolution: 1024×768) video: AVI (resolution: 1024×768)
Image process	brightness, image zoom (1X, 1.5X, 2X, 2.5X, 3X)
Screen	5" LCD, resolution: 1200×720, can rotate 180°
Temperature	display the temperature of probe
Memory	32G SD card
Output	TV, USB, HDMI
Power supply	rechargeable battery (for 4 hours working) AC/DC adapter (for continuous working)
Weight	600g

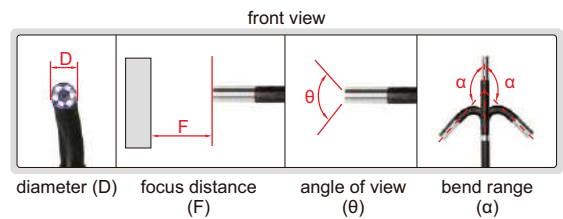
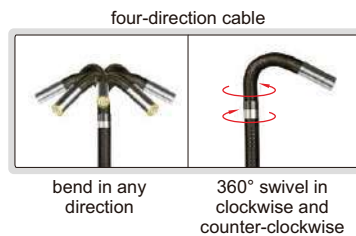

FOUR-DIRECTION CABLE (FRONT VIEW)

Code		ISV-MSU610	ISV-MSU615	ISV-MSU630	ISV-MSU410	ISV-MSU415	ISV-MSU430	
Cable	length	1m	1.5m	3m	1m	1.5m	3m	
	type	tungsten wire weaved cable						
Lens	view direction	front view						
	bend direction	four directions						
	diameter (D)	6.5mm			4.5mm			
	focus distance (F)	15mm~∞			8~80mm			
	bend range (α)	±160°			±120°			
	angle of view (θ)	>120°						
	illumination	6 pcs LED						
	pixel	0.92M						
resolution	1280×720							

To be continued

18

19

Continued from previous page

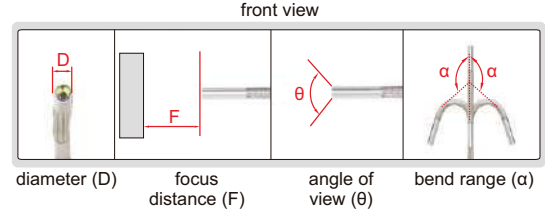
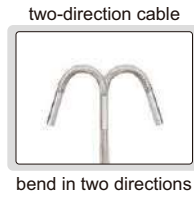

TWO-DIRECTION CABLE (MICRO)

Code	Cable		Lens								
	length	type	view direction	bend direction	diameter (D)	foucus distance (F)	bend range (α)	angle of view (θ)	illumination	pixel	resolution
ISV-MSU215	1.5m	tungsten wire weaved cable	front view	two directions	2.4mm	5~30mm	$\pm 160^\circ$	$> 120^\circ$	2 pcs LED	0.30M	640×480

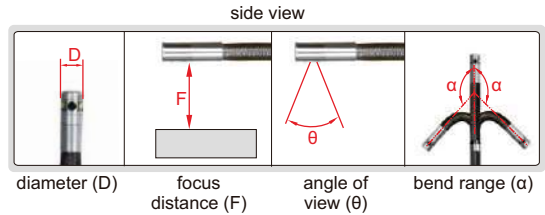
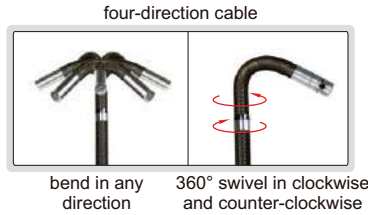

SIDE VIEW CABLE

Code	Cable		Lens								
	length	type	view direction	bend direction	diameter (D)	foucus distance (F)	bend range (α)	angle of view (θ)	illumination	pixel	resolution
ISV-MSU611	1.5m	tungsten wire weaved cable	side view	four directions	6mm	8~80mm	$\pm 160^\circ$	$> 120^\circ$	2 pcs LED	0.92M	1280×720

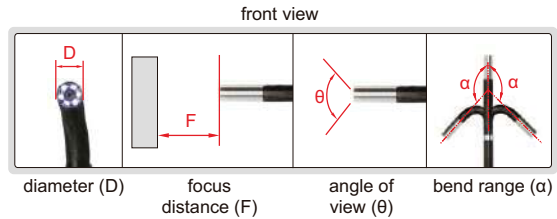
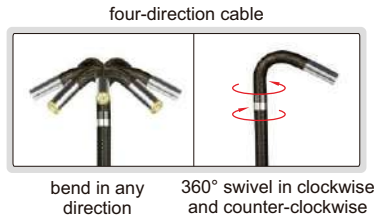

HIGH-DEFINITION CABLE

Code	Cable		Lens								
	length	type	view direction	bend direction	diameter (D)	foucus distance (F)	bend range (α)	angle of view (θ)	illumination	pixel	resolution
ISV-MSU617	2m	tungsten wire weaved cable	front view	four directions	6mm	15mm~∞	$\pm 160^\circ$	$> 120^\circ$	6 pcs LED	2.07M	1080×1920

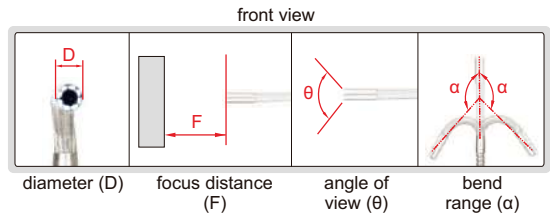
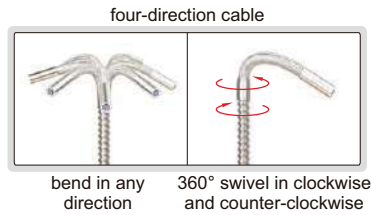

SCREWED CABLE (WEAR RESISTANCE, SUITABLE FOR CASTINGS, ENGINES, ETC.)

Code	Cable		Lens								
	length	type	view direction	bend direction	diameter (D)	foucus distance (F)	bend range (α)	angle of view (θ)	illumination	pixel	resolution
ISV-MSU612	1.5m	stainless steel screwed cable	front view	four directions	6mm	15mm~∞	$\pm 160^\circ$	$> 120^\circ$	6 pcs LED	0.92M	1280×720

To be continued

Continued from previous page

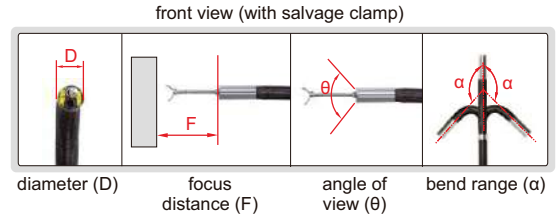
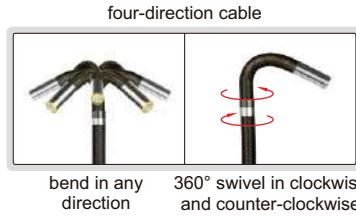

CABLE WITH CLAMP (MAXIMUM OPENING OF CLAMP IS 7mm)

Code	Cable		Lens								
	length	type	view direction	bend direction	diameter (D)	focous distance (F)	bend range (α)	angle of view (θ)	illumination	pixel	resolution
ISV-MSU613	1.5m	tungsten wire weaved cable	front view	four directions	6mm	15mm~∞	±160°	>120°	4 pcs LED	0.92M	1280×720

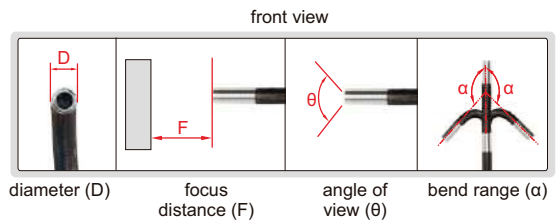
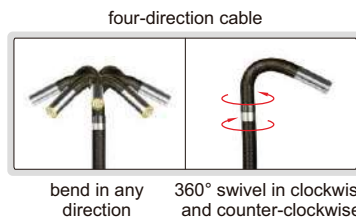

INFRARED FIBER CABLE

Code	Cable		Lens								
	length	type	view direction	bend direction	diameter (D)	focous distance (F)	bend range (α)	angle of view (θ)	illumination	pixel	resolution
ISV-MSU614	1.5m	tungsten wire weaved cable	front view	four directions	6mm	1mm~∞	±160°	>120°	2 pcs rear infrared fiber lighting	0.92M	1280×720

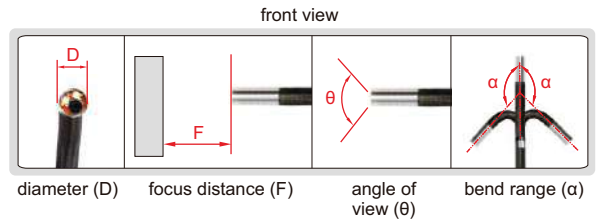
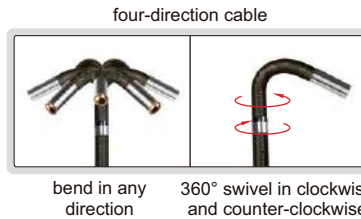

ULTRAVIOLET CABLE

Code	Cable		Lens								
	length	type	view direction	bend direction	diameter (D)	focous distance (F)	bend range (α)	angle of view (θ)	illumination	pixel	resolution
ISV-MSU720	2m	tungsten wire weaved cable	front view	four directions	7mm	5~50mm	±160°	>120°	2 pcs ultraviolet LED	0.92M	1280×720

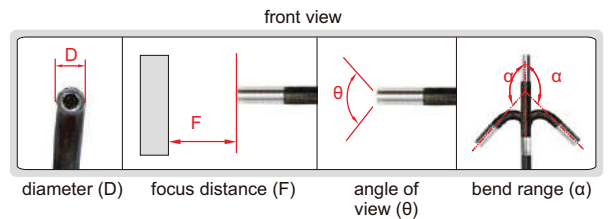
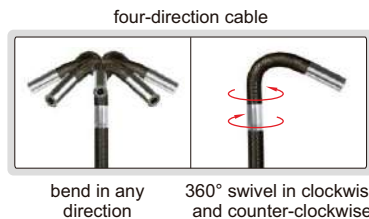

FIBER CABLE

Code	Cable		Lens								
	length	type	view direction	bend direction	diameter (D)	focous distance (F)	bend range (α)	angle of view (θ)	illumination	pixel	resolution
ISV-MSU616	1.5m	tungsten wire weaved cable	front view	four directions	6mm	15mm~∞	±160°	>120°	2 pcs rear fiber lighting	0.92M	1280×720

HIGH-DEFINITION 360° SWIVEL VIDEOSCOPIES

IP64
WATERPROOF

TUNGSTEN WIRE WEAVED CABLE
BREAK AND WEAR RESISTANCE

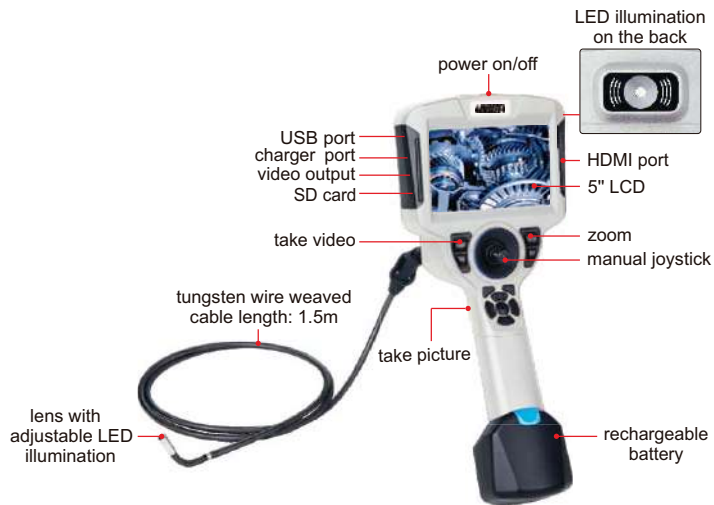

ISV-MS726

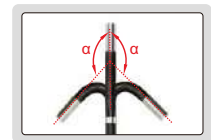
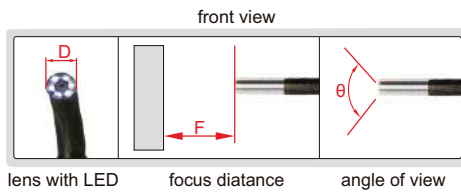

SPECIFICATION

Code	ISV-MS726	ISV-MS724	
Lens	diameter (D)	6.5mm	4.5mm
	lens bending range (α)	±160°	±120°
	focus distance (F)	15mm~∞	8~80mm
	viewing angle (θ)	>120°	
	illumination	6 pcs LED	
	pixel	0.92M	
	resolution	1280x720	
	dust/waterproof	IP64	
	bend control	manual joystick	
	Cable	length	1.5m
type		tungsten wire weaved cable	
Main unit	function	take picture, take video	
	file format	picture: JPG, video: AVI	
	image process	brightness, image quality zoom (1X, 1.5X, 2X, 2.5X, 3X)	
	memory	32G SD card	
	output	TV, USB, HDMI	
	temperature sensing	display real-time temperature of the probe	
	screen rotation	180°	
	power supply	rechargeable battery (for 4 hours working) AC/DC adapter (for continuous working)	
Weight	600g		

connect to 13.3" high-definition display (optional)



STANDARD DELIVERY

Main unit	1 pc
Cable with lens	1 pc
32G SD card	1 pc
AC/DC adapter	1 pc
Video output cable	1 pc
USB cable	1 pc

OPTIONAL ACCESSORY

13.3" high-definition display (with HDMI cable)	DL300-DISPLAY
---	---------------

IP64
WATERPROOF

TUNGSTEN WIRE WEAVED CABLE
RESISTANCE TO BREAK AND WEAR



360° SWIVEL VIDEOSCOPIES

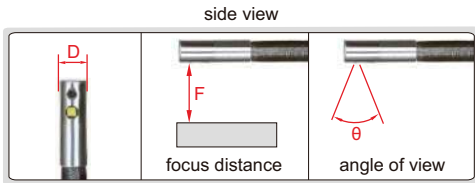
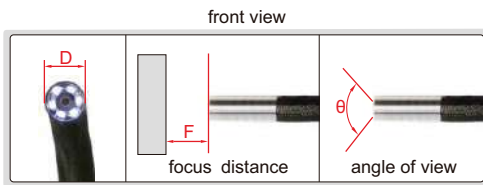
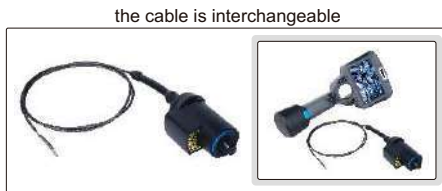

ISV-2000DS

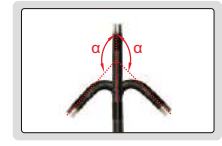

SPECIFICATION

Code	ISV-2002DS	ISV-2000DS	ISV-2001DS	ISV-3002DS	ISV-3000DS	ISV-3001DS	ISV-4000DS	
Lens	direction	front view					side view	
	diameter (D)	6.5mm			4.5mm		6.5mm	
	focus distance (F)	15mm~∞			8~80mm		5~25mm	
	bending range (α)	±160°	±160°	±120°	±120°	±120°	±120°	±160°
	angle of view (θ)	90°			80°		>90°	
	illumination	6 pcs LED			6 pcs LED		1 pc LED	
	pixel	0.44M			0.4M		0.3M	
	resolution	800×480					640×480	
	dust/waterproof	IP64						
	bend control	manual joystick						
Cable	length	1m	1.5m	3m	1m	1.5m	3m	1.5m
	type	tungsten wire weaved cable						
Main unit	function	take picture, take video						
	file format	picture: JPG, video: AVI						
	image process	brightness, image quality zoom (1X, 2X, 3X)						
	memory	8G SD card						
	output	TV, USB						
power supply	rechargeable battery (for 4 hours working) AC/DC adapter (for continuous working)							
Weight	600g	650g	800g	550g	600g	700g	650g	

STANDARD DELIEVERY

Main unit	1 pc
Cable with lens	1 pc
8G SD card	1 pc
AC/DC adapter	1 pc
Video output cable	1 pc
USB cable	1 pc

MULTIPURPOSE VIDEOSCOPE



MAIN UNIT

Code	VSP-201
Function	take picture, take video
File format	picture: JPG, video: AVI
Image process	brightness, contrast
Memory	32GB
Output	TV, USB
Power supply	rechargeable battery (for 4 hours working)
Dimension	260×170×65mm
Weight	1.2kg

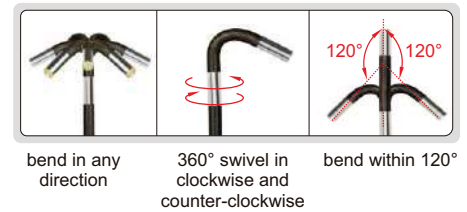
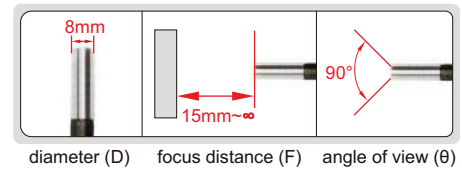

FOUR-DIRECTION CABLE (FRONT VIEW)

Code	Cable		Lens						
	length	type	diameter (D)	focous distance (F)	angle of view (θ)	illumination	pixel	resolution	dust/waterproof
VSP-201D	3m	tungsten wire weaved cable	8mm	15mm~∞	90°	6 pcs LED	1M	1280×720	IP67

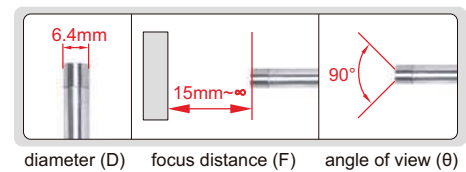

RIGID CABLE

Code	Cable		Lens						
	length	type	diameter (D)	focous distance (F)	angle of view (θ)	illumination	pixel	resolution	dust/waterproof
VSP-201H	250mm	stainless steel	6.4mm	15mm~∞	90°	6 pcs LED	1M	1280×720	IP64

To be continued

Continued from previous page

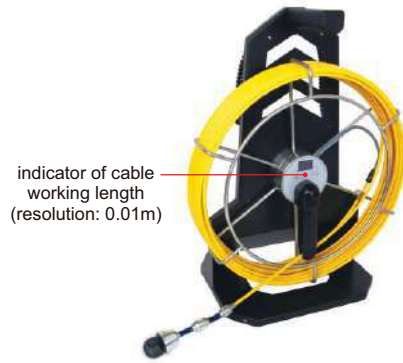

support wheel (included)

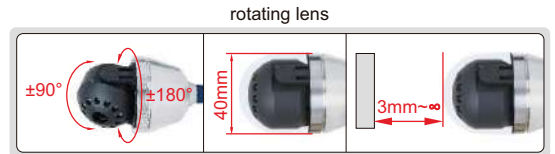

rotating lens

±90° rotation in radial direction, ±180° rotation in axial direction

diameter (D)

focus distance (F)

ROTATING LENS CABLE

Code	Cable		Lens						
	length	type	diameter (D)	focous distance (F)	illumination	pixel	resolution	dust/waterproof	lens control
VSP-201R	30m	high strength glass fibre	40mm	3mm~∞	12 pcs LED	0.3M	800×480	IP67	motorized

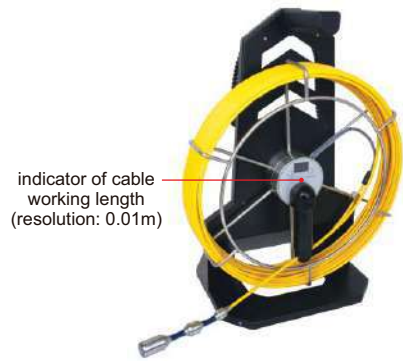

support wheel (included)

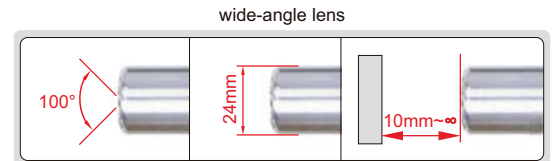

wide-angle lens

angle of view (θ)

diameter (D)

focus distance (F)

WIDE-ANGLE LENS CABLE

Code	Cable		Lens						
	length	type	diameter (D)	focous distance (F)	angle of view (θ)	illumination	pixel	resolution	dust/waterproof
VSP-201W	30m	high strength glass fibre	24mm	10mm~∞	100°	12 pcs LED	0.3M	800×480	IP67



application



ADJUSTABLE SUPPORT

Code	Working diameter (D)	Remark
VSP-201-R200	60~200mm	for VSP-201R or VSP-201W

SIDE VIEW VIDEOSCOPE (RIGID) CODE ISV-RV



IP57
WATERPROOF

to observe internal wall of holes
(minimum diameter Ø10mm)



SPECIFICATION

Diameter (D)	5.5mm
Length (L)	350mm
Dust/waterproof probe	IP57
Pixel	0.3M
Resolution	640×480
Frame rate	30fps
Function	take picture, take video
File format	picture: JPG, video: AVI
Memory	2G SD card
Output	TV, USB
Power supply	rechargeable battery (for 3 hours working)
Weight	570g

STANDARD DELIVERY

Main unit	1 pc
2G SD card	1 pc
AC/DC adapter	1 pc
Video output cable	1 pc
USB cable	1 pc

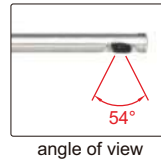

angle of view



focus distance



side view

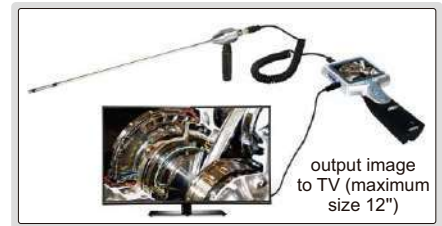

output image to TV (maximum size 12")

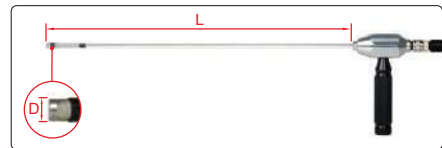

VIDEOSCOPE CODE ISV-E10



ATTENTION: THE CABLE CAN BE BENT BUT CAN'T BE SET AT A FIXED SHAPE

OPTIONAL CABLE LENGTH 3M, 5M AND 10M

IP65
WATERPROOF

SPECIFICATION

Lens	diameter	5.5mm
	pixel	0.3M
	resolution	640×480
	frame rate	30fps
Cable	length	1m
	type	steel wire weaved cable
Main unit	function	take picture, take video
	file format	picture: JPG, video: AVI
	image process	brightness, contrast, color saturation
	memory	2G SD card
	output	TV, USB
power supply	rechargeable battery (for 3 hours working)	
Weight	450g	

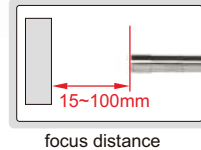

focus distance

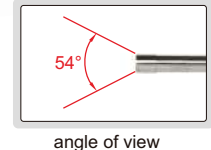

angle of view

STANDARD DELIVERY

Main unit	1 pc
Cable with lens	1 pc
2G SD card	1 pc
45° mirror	1 pc
AC/DC adapter	1 pc
Video output cable	1 pc
USB cable	1 pc
Lens cleaning kit	1 pc

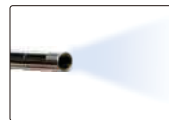

front view



side view (with mirror)

OPTIONAL ACCESSORY

35° mirror	ISV-E55-M35
60° mirror	ISV-E55-M60

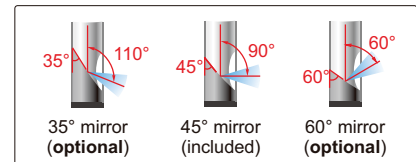

35° mirror (optional)

45° mirror (included)

60° mirror (optional)

IP57
WATERPROOF

the cable has high illumination and can be set at any shape. it is suitable to observe large internal space like turbocharger.

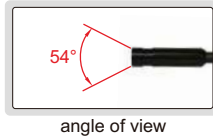
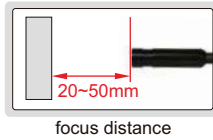

memory cable length: 1m



LED brightness adjustment

VIDEOSCOPE CODE ISV-E20

SPECIFICATION

Lens	diameter (D)	12mm
	pixel	0.4M
	resolution	720×682
	frame rate	30fps
Cable	length	1m
	type	memory (can be set at any shape)
Main unit	function	take picture, take video
	file format	picture: JPG, video: AVI
	image process	brightness, contrast, color saturation
	memory	2G SD card
	output	TV, USB
Weight	power supply	rechargeable battery (for 3 hours working)
	Weight	600g



STANDARD DELIVERY

Main unit	1 pc
Cable with lens	1 pc
2G SD card	1 pc
AC/DC adapter	1 pc
Video output cable	1 pc
USB cable	1 pc
Lens cleaning kit	1 pc

OPTIONAL ACCESSORY

45° mirror	ISV-E20-MIRROR
Hook	ISV-E20-HOOK
Magnet pick up	ISV-E20-MAGNET

RIGID BORESCOPIES

IP67
WATERPROOF



ISV-1H4300

- Focus distance: 2mm, depth of view: 5~100mm
- Dust/waterproof level: IP67
- Can be used in liquid with temperature -10°C~85°C

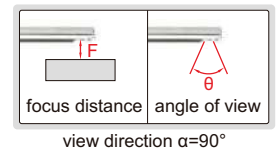
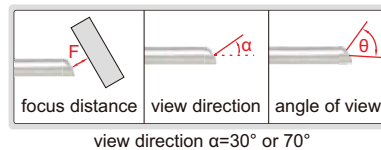
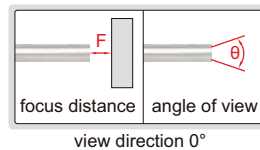

SPECIFICATION

Code	Length (L)	View direction (α)	Diameter (D)	Angle of view (θ)
ISV-1H4170	174mm	0°	4mm	≥60°
ISV-1H4173	174mm	30°		
ISV-1H4177	174mm	70°		
ISV-1H4179	166mm	90°		
ISV-1H4300	302mm	0°		
ISV-1H4303	302mm	30°		
ISV-1H4307	302mm	70°		
ISV-1H4309	297mm	90°		

Code	Length (L)	View direction (α)	Diameter (D)	Angle of view (θ)
ISV-1H6200	209mm	0°	6mm	≥70°
ISV-1H6203	209mm	30°		
ISV-1H6207	209mm	70°		
ISV-1H6209	166mm	90°		
ISV-1H6320	328mm	0°		
ISV-1H6323	328mm	30°		
ISV-1H6327	328mm	70°		
ISV-1H6329	330mm	90°		

OPTIONAL ACCESSORY

LED light handle	ISV-1HLED
Adjustable LED light source	ISV-1LED1
Camera	ISV-2CAM



LED LIGHT HANDLE CODE ISV-1HLED

- For rigid borescopes



battery (included)



charger (included)

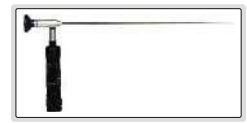

SPECIFICATION

Power	3W
Battery	3.7V rechargeable battery (for 2 hours working)
Dimension	120×27×27mm
Weight	300g

STANDARD DELIVERY

Main unit	1 pc
Battery	1 pc
Charger	1 pc

ADJUSTABLE LED LIGHT SOURCE CODE ISV-1LED1

- For rigid borescopes
- High LED illumination and brightness is adjustable
- For long time work with low noise



SPECIFICATION

Color temperature	5600K
Cooling	fan cooling
Power	AC110~220V, 50/60Hz
Dimension	400×300×112mm
Weight	7kg

STANDARD DELIVERY

Main unit	1 pc
1.8m optical fiber cable	1 pc

CAMERA (WITH DISPLAY) CODE ISV-2CAM

TAKE PICTURES
AND VIDEOS

AUTO FOCUS

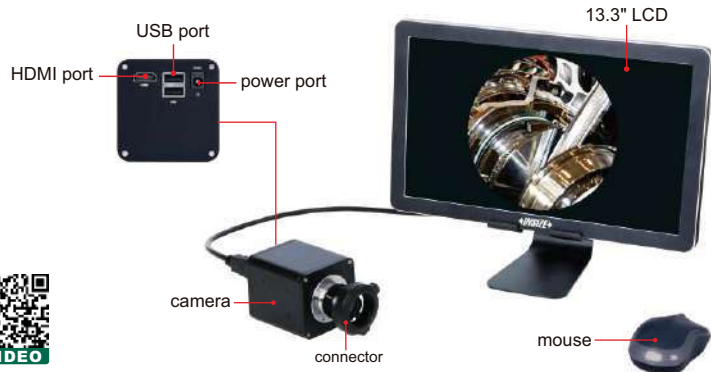
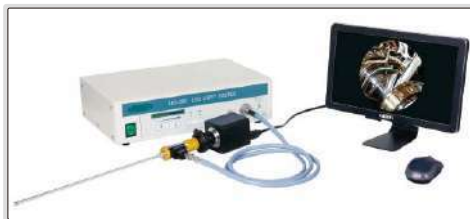

- For rigid borescopes
- 1080P high-definition image
- Auto-focus camera
- Take pictures and videos, saved to USB flash disk
- Automatic white balance and exposure
- Brightness, contrast ratio, gain are adjustable



SPECIFICATION

Sensor	1/2.8" CMOS
Pixel	2M
Resolution	1920×1080
Frame rate	60fps
Output	HDMI
Power supply	power adapter
Dimension (L×W×H)	350×100×430mm
Weight	2kg

STANDARD DELIVERY

Camera	1 pc
Connector	1 pc
13.3" LCD	1 pc
16G USB flash disk	1 pc
Mouse	1 pc
HDMI cable	1 pc
Power adapter	2 pcs



16G USB flash disk
(included)

DATA OUTPUT

CAN BE CONTROLLED BY COMPUTER

- 21 roughness parameters
- Display roughness value, profile and curve
- Memory of maximum 100 results
- Automatic power off



Unit: mm



printer (optional)

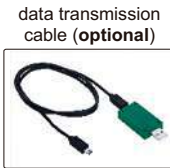

data transmission cable (optional)



probe cover (included)

put the small workpieces directly under the probe for measurement



adjustable stand (included)

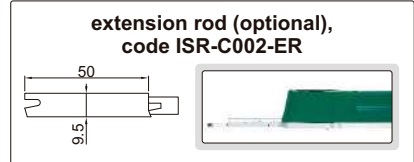

extension rod (optional), code ISR-C002-ER



transverse rod (optional), code ISR-C002-TR

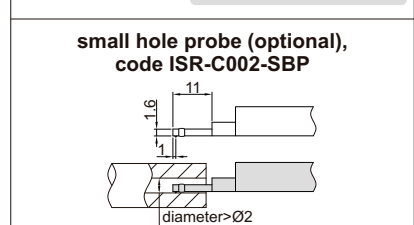

small hole probe (optional), code ISR-C002-SBP

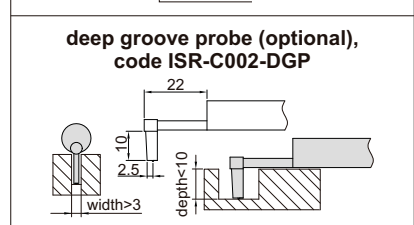

deep groove probe (optional), code ISR-C002-DGP

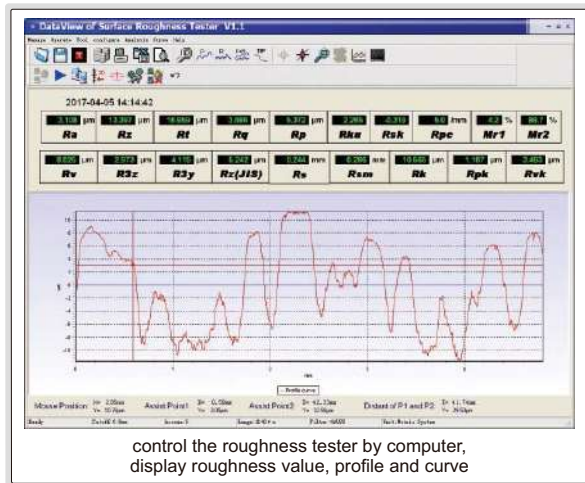

software (included)

control the roughness tester by computer, display roughness value, profile and curve

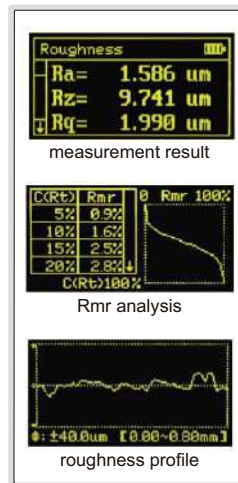

screen display

measurement result



Rmr analysis



roughness profile



software CD (included)



light duty test stand (optional)

the maximum workpiece height is 220mm



heavy duty test stand (optional)

the maximum workpiece height is 310mm

SPECIFICATION

Parameters		Ra, Rz, Rq, Rv, Rp, RS, R3z, R3y, Rt, Rz (JIS), Rk, Rku, Rsm, Rpc, Rpk, Rvk, Rsk, Mr1, Mr2, Ry (JIS), Rmax
Range		160µm
Accuracy		±10%
Resolution (Ra)		0.001µm
Probe	type	inductive
	stylus radius/angle	5µm/90°
	stylus material	diamond
Measuring force		4mN
Measuring unit		µm/µin
Cut off		0.25/0.8/2.5mm
Number of cut-off		1 to 5
Traverse speed		0.5mm/s, 1mm/s
Memory		100 measurement results
Output		USB
Power		built-in rechargeable battery
Dimension (L×W×H)		141×55×40mm
Weight		400g

STANDARD DELIVERY

Main unit	1 pc
Standard probe	1 pc
Calibration block and support	1 pc of each
Adjustable stand	1 pc
Probe cover	1 pc
Software	1 pc
AC/DC adapter	1 pc

OPTIONAL ACCESSORY

Extension rod	ISR-C002-ER
Transverse rod	ISR-C002-TR
Deep groove probe	ISR-C002-DGP
Small hole probe	ISR-C002-SBP
Light duty test stand	ISR-C002-STAND1
Heavy duty test stand	ISR-C002-STAND
Printer	ISR-C002-PRINTER
Data transmission cable	ISR-C002-SPC

ROUGHNESS TESTER CODE ISR-S400

INSIZE PLUS
MADE IN ITALY



- Automatic probe leveling
- Language: English, French, German, Italian, Spanish, Portuguese
- 12 roughness parameters
- Can set tolerance
- Measuring range up to 400µm, can measure grit and shot blasting
- Traverse length up to 16mm
- The probe can be set at 90° or 270°, for transverse measurement
- Memory of maximum 100 results

PROBE CAN
BE REPLACED

DATA
OUTPUT

CUSTOM-MADE
PROBES ARE AVAILABLE



software CD (included)



adjustable stand (included)



transverse measurement



probe cover (included), can put the small workpieces directly on the probe for measurement



output software (included), output data and graphic to Excel, make report, print

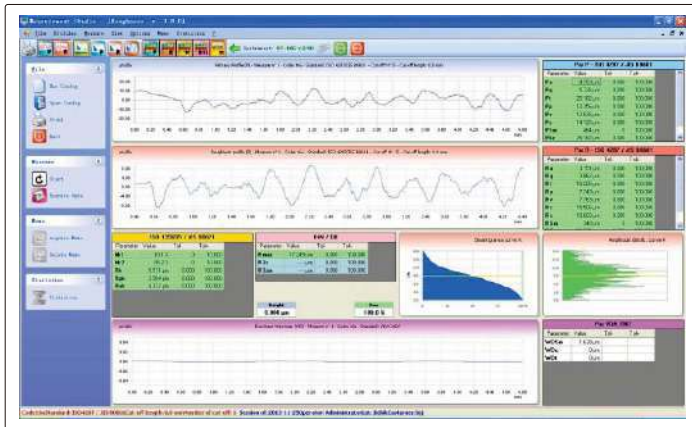

measuring software (optional), can control the roughness tester, display roughness values, profile and curve, data statistics



heavy duty test stand (optional)



light duty test stand (optional)

SPECIFICATION

Parameters	Ra, Rq, Rt, Rz, Rc, Rmax, Rsm, Rpc, Rmr, R, AR, Rx	
Range	Ra: 0~100µm, Rt: 0.05~400µm	
Accuracy	±3%	
Resolution (Ra)	0.001µm	
Probe	type	inductive
	stylus radius/angle	5µm/90°
	stylus material	diamond
Measuring force	0.75mN	
Measuring unit	µm/µin	
Cut off	0.25/0.8/2.5mm	
Number of cut-offs	1 to 5	
Traverse speed	1mm/s	
Memory	100 measurement results	
Output	USB	
Power	built-in rechargeable battery	
Dimension (L×W×H)	122×52×68mm	
Weight	650g	

STANDARD DELIVERY

Main unit	1 pc
Standard probe	1 pc
Calibration block	1 pc
Adjustable stand	1 pc
AC/DC adapter	1 pc
Probe cover	1 pc
USB cable and output software	1 pc

OPTIONAL ACCESSORY

Extension rod	ISR-S400-ER100
Probe	see details
Measuring software	ISR-S-SOFTWARE
Heavy duty test stand	ISR-S400-DK
Light duty test stand	ISR-S400-STAND

To be continued

Continued from previous page

SPECIFICATION OF PROBES

Unit: mm

<p>standard probe (included)</p> <p>measure plane surfaces, holes and cylinders with diameter > $\varnothing 10$mm</p>	<p>small roughness probe (optional) code ISR-S400-SB10R2</p> <p>measure surfaces with small roughness</p>
<p>extension rod (optional) code ISR-S400-ER100</p> <p>for long holes</p>	
<p>groove probe (optional) code ISR-S400-SB20</p> <p>measure plane surfaces and grooves</p>	<p>deep groove probe (optional) code ISR-S400-SB120</p> <p>measure grooves with depth < 20mm</p>
<p>small hole probe (optional) code ISR-S400-SB30</p> <p>measure plane surfaces and holes with diameter > $\varnothing 4$mm and depth < 20mm</p>	<p>deep hole probe (optional) code ISR-S400-SB80</p> <p>measure holes with diameter > $\varnothing 4.5$mm and depth < 35mm</p>
<p>small rod probe (optional) code ISR-S400-SB40</p> <p>measure small rods with diameter $\varnothing 1-5$mm</p>	<p>cylinder/hole probe (optional) code ISR-S400-SB110</p> <p>measure cylinders and holes with radius > 5mm</p>
<p>transverse probe (optional) code ISR-S400-SB50</p> <p>transverse measurement for plane surfaces, cylinders and grooves</p>	<p>internal angle probe (optional) code ISR-S400-SB140</p> <p>measure internal angles</p>

ROUGHNESS TESTER (SEPARABLE TYPE) CODE ISR-C300

BLUETOOTH

TOUCH SCREEN

CAN BE OPERATED BY
COMPUTERS OR MOBILE PHONES

DATA
OUTPUT



- Roughness tester can be operated by mobile phones (only android system) or computers
- Data can be sent to Excel by connecting with computers via bluetooth or USB cable
- Support bluetooth printer
- 22 roughness parameters
- Meet ISO, DIN, ANSI, JIS standards
- Display roughness values, profile and curve
- Memory of maximum 100 data and waveform
- Built-in lithium battery, working time more than 50 hours
- Touch screen
- Automatic power off



software CD (included)

probe and main unit can be combined together

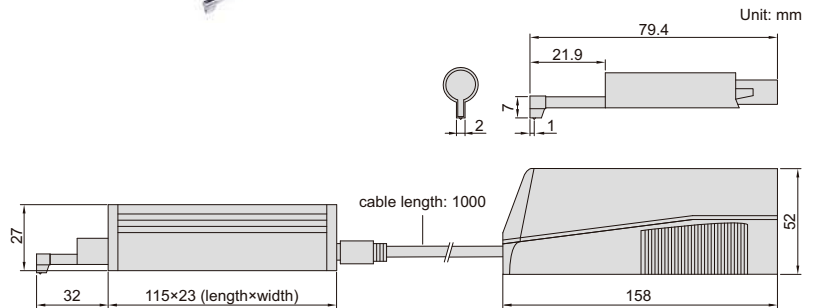

roughness tester
screen display

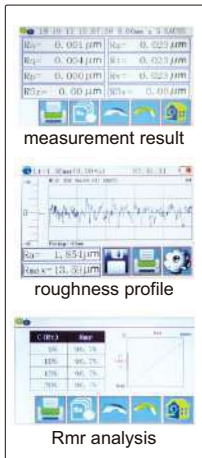

connect mobile phone via bluetooth
(only android system)



connect computer via USB cable (software is included)

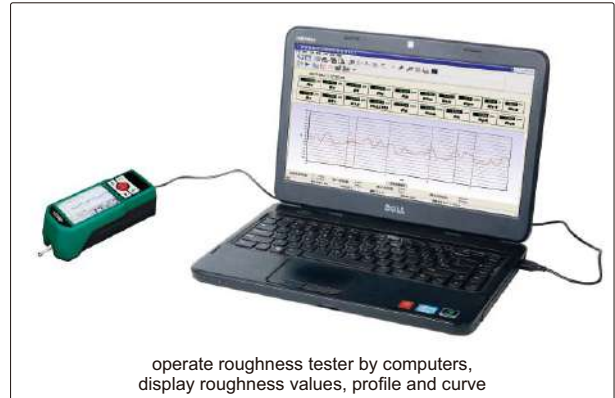

data can be sent to Excel by
connecting with computer via bluetooth or USB cable

bluetooth receiver
(optional)



adjustable stand (included)

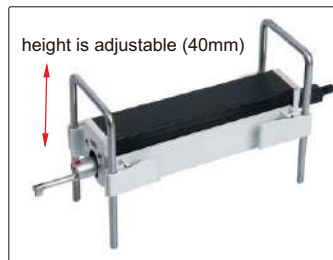

bluetooth printer (optional)



To be continued

Continued from previous page

magnetic stand adapter (included)



height gage adapter (optional)

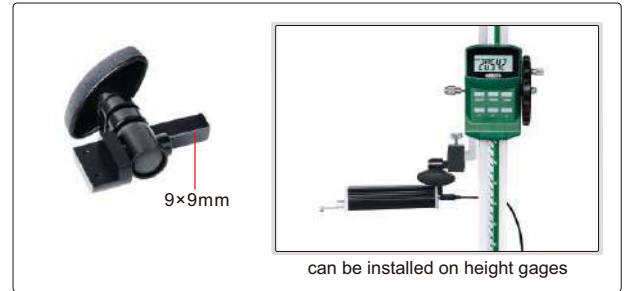

NOTE: Please check whether the adapter can fit your height gages. When using **INSIZE** height gages, please use the dial test indicator holder of height gages

probe support (optional)

support for flat surface

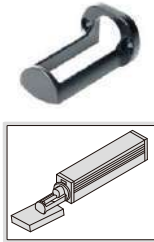

support for cylindrical surface

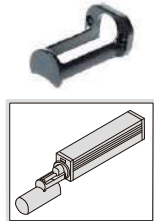

optional probes

Unit: mm

extension rod (optional), code **ISR-C002-ER**

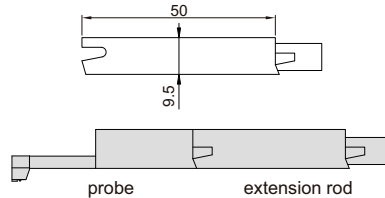

small hole probe (optional), code **ISR-C002-PROBE**

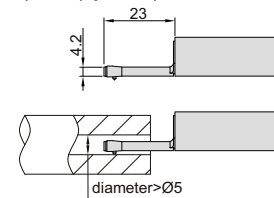

tiny hole probe (optional), code **ISR-C002-SBP**

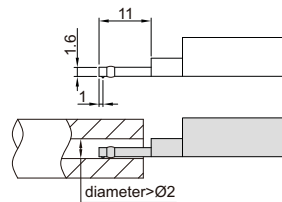

deep groove probe (optional), code **ISR-C002-DGP**

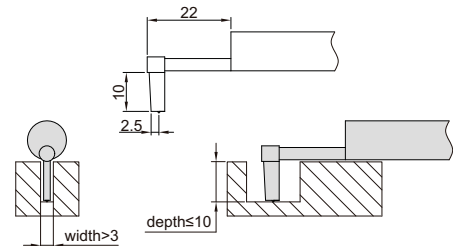

SPECIFICATION

Parameters		Ra, Rz, Rq, Rv, Rp, Rs, R3z, R3y, Rt, Rc, Rz (JIS), Rk, Rku, Rsm, Rpc, Rpk, Rvk, Rsk, Mr1, Mr2, Ry, Rmax
Range	X axis	17.5mm
	Z axis	320µm (-160µm~160µm)
Accuracy		±10%
Resolution (Ra)		0.001µm
Probe	type	inductive
	stylus radius/angle	5µm/90°
	stylus material	diamond
Measuring force		4mN
Measuring unit		µm/µin
Cut off		0.25/0.8/2.5mm
Number of cut-offs		1~5
Traverse speed		0.135mm/s, 0.5mm/s, 1mm/s
Memory		100 measurement results
Output		USB and bluetooth
Power		built-in rechargeable battery
Dimension (L×W×H)		158×64×52mm
Weight		400g

STANDARD DELIVERY

Main unit	1 pc
Standard probe	1 pc
Calibration block and support	1 pc of each
Connecting cable (long and short)	1 pc of each
Magnetic stand adapter	1 pc
Adjustable stand	1 pc
Touch pen	1 pc
USB cable and software	1 pc
AC/DC adapter	1 pc

OPTIONAL ACCESSORY

Extension rod	ISR-C002-ER
Small hole probe	ISR-C002-PROBE
Tiny hole probe	ISR-C002-SBP
Deep groove probe	ISR-C002-DGP
Bluetooth printer	ISR-C002-PRINTER
Height gage adapter	ISR-C300-LB1
Bluetooth receiver	ISR-C300-RECEIVER
Support for flat surface	ISR-C300-COVER1
Support for cylindrical surface	ISR-C300-COVER2

ROUGHNESS TESTER CODE ISR-C003



calibration block
(included)



- Unit: μm , μin
- Automatic power off

SPECIFICATION

Parameters	Ra, Rz, Rq, Rt	
Range	Ra, Rq: 0.05~15 μm Rz, Rt: 0.1~50 μm	
Accuracy	$\pm 10\%$	
Resolution (Ra)	0.01 μm	
Probe	type	piezoelectric
	stylus radius/angle	10 $\mu\text{m}/90^\circ$
	stylus material	diamond
Measuring force	5mN	
Measuring unit	$\mu\text{m}/\mu\text{in}$	
Cut off	0.25/0.8/2.5mm	
Evaluation length	1.25mm for cut off 0.25mm 4mm for cut off 0.8mm 5mm for cut off 2.5mm	
Traverse speed	0.75mm/s	
Power	built-in rechargeable battery	
Dimension (L×W×H)	106×70×24mm	
Weight	200g	

STANDARD DELIVERY

Main unit	1 pc
Calibration block	1 pc
AC/DC adapter	1 pc

SURFACE ROUGHNESS SPECIMENS



- For checking, identifying and specifying the roughness by symbol
- Rust-proof, made of pure Nickel



ISR-CS315

Code	Machining method	Roughness (Ra)	Roughness (Rz)	Quantity
ISR-CS315	Surface grinding	0.025, 0.05, 0.1, 0.2, 0.4, 0.8, 1.6, 3.2 μm	0.29, 0.55, 0.91, 1.74, 2.6, 4.65, 7.87, 15.6 μm	8 pcs
ISR-CS316	Cylindrical grinding	0.025, 0.05, 0.1, 0.2, 0.4, 0.8, 1.6, 3.2 μm	0.3, 0.53, 0.88, 1.56, 2.64, 4.4, 7.71, 15.3 μm	8 pcs
ISR-CS317	Flat lapping	Criss-cross	0.025, 0.05, 0.1, 0.2 μm	0.4, 0.6, 0.74, 1.26 μm
		Parallel	0.025, 0.05, 0.1, 0.2 μm	0.34, 0.56, 1.12, 1.5 μm
ISR-CS318	Cylindrical lapping	0.025, 0.05, 0.1, 0.2 μm	0.46, 0.54, 0.63, 1.23 μm	4 pcs
	Superfinishing	0.025, 0.05, 0.1, 0.2 μm	0.36, 0.7, 1, 1.4 μm	4 pcs
ISR-CS319	Face turning	0.4, 0.8, 1.6, 3.2, 6.3, 12.5, 25, 50 μm	1.92, 3.2, 6.15, 12.5, 23.7, 48.7, 102, 185 μm	8 pcs
ISR-CS320	Cylindrical turning	0.4, 0.8, 1.6, 3.2, 6.3, 12.5, 25, 50 μm	1.7, 3.2, 6.1, 12.2, 23.7, 47.5, 95, 190 μm	8 pcs
ISR-CS321	End milling	0.4, 0.8, 1.6, 3.2, 6.3, 12.5, 25, 50 μm	1.92, 3.82, 6.45, 12.2, 25.2, 49.8, 92.6, 191 μm	8 pcs
ISR-CS322	Reaming	0.4, 0.8, 1.6, 3.2 μm	1.7, 3.2, 6.4, 12.8 μm	4 pcs
	Drilling	1.6, 3.2, 6.3, 12.5 μm	7.5, 15.5, 31, 60 μm	4 pcs
ISR-CS323	Horizontal milling	0.4, 0.8, 1.6, 3.2, 6.3, 12.5, 25, 50 μm	1.8, 3.68, 6.63, 12.8, 25.6, 53, 97.5, 197 μm	8 pcs
ISR-CS325	Shaping (planing)	0.8, 1.6, 3.2, 6.3, 12.5, 25, 50, 100 μm	3.84, 6.7, 12.2, 25.2, 48.7, 99.9, 190, 361 μm	8 pcs
ISR-CS326	Linishing (belt sanding)	0.1, 0.2, 0.4, 0.8, 1.6, 3.2 μm	0.9, 1.55, 3.37, 7.42, 18.5, 31 μm	6 pcs
ISR-CS328	Vertical grinding	0.2, 0.4, 0.8, 1.6, 3.2, 6.3 μm	1.1, 3.5, 6.15, 8.78, 22.19, 40.8 μm	6 pcs
ISR-CS329	Grit blasting	3.2, 10.5, 18, 25 μm	19.2, 63, 108, 150 μm	4 pcs
	Shot blasting	3.2, 8, 13, 18 μm	19.2, 48, 78, 108 μm	4 pcs
ISR-CS331	Spark erosion (EDM)	0.4, 0.8, 1.6, 3.2, 6.3, 12.5, 25, 50 μm	2.5, 4.5, 7.2, 14.2, 24.7, 51.2, 105, 196 μm	8 pcs
ISR-CS333	Hand filing	0.4, 0.8, 1.6, 3.2, 6.3 μm	3, 5.6, 12.4, 22.5, 61 μm	5 pcs
ISR-CS334	Castings	0.8, 1.6, 3.2, 6.3, 12.5, 25, 50 μm	3.2, 8, 16, 32, 56, 112, 225 μm	7 pcs
ISR-CS335	Honing	0.05, 0.1, 0.2, 0.4, 0.8, 1.6 μm	0.31, 0.56, 1, 2, 4.2, 9 μm	6 pcs
ISR-CS336	Polishing	0.0125, 0.025, 0.05, 0.1, 0.2 μm	0.29, 0.35, 0.67, 0.72, 1.52 μm	5 pcs

SURFACE ROUGHNESS SPECIMEN SET CODE ISR-CS130-W

INSIZE PLUS
MADE IN UK

- For checking, identifying and specifying the roughness by symbol
- Rust-proof, made of pure Nickel



Machining method	Roughness (Ra)	Roughness (Rz)	Quantity
Flat lapping	0.05, 0.1, 0.2µm	0.55, 1, 1.6µm	3 pcs
	2, 4, 8µm		
Reaming	0.4, 0.8, 1.6µm	3, 6, 10µm	3 pcs
	16, 32, 63µm		
Plain grinding	0.05, 0.1, 0.2, 0.4, 0.8, 1.6µm	0.55, 1, 1.6, 3, 6, 10µm	6 pcs
	2, 4, 8, 16, 32, 63µm		
Horizontal milling	0.4, 0.8, 1.6, 3.2, 6.3, 12.5µm	2.5, 4, 8, 16, 32, 50µm	6 pcs
	16, 32, 63, 125, 250, 500µm		
Vertical milling	0.4, 0.8, 1.6, 3.2, 6.3, 12.5µm	2.5, 4, 8, 16, 32, 50µm	6 pcs
	16, 32, 63, 125, 250, 500µm		
Turning	0.4, 0.8, 1.6, 3.2, 6.3, 12.5µm	2.5, 4, 8, 16, 32, 50µm	6 pcs
	16, 32, 63, 125, 250, 500µm		

MEASURING ACCURACY CAN BE IMPROVED, IF THE CALIBRATION IS MADE ON A REFERENCE SPECIMEN WITH THE ROUGHNESS VALUE CLOSE TO THE WORKPIECE TO BE MEASURED

SURFACE ROUGHNESS REFERENCE SPECIMENS

INSIZE PLUS
MADE IN UK

- To calibrate roughness testers
- Meets ISO 5436-1: 2000
- Rust proof, made of pure Nickel

Code	Roughness (Ra)
ISR-RS525X	6.25µm *
ISR-RS526X	3.15µm *
ISR-RS527X	3.0µm *
ISR-RS528X	0.5µm *
ISR-RS529X	0.1µm * (not suitable for ISR-S400)
ISR-RS530X	1.0µm *
ISR-RS531X	0.3µm * (not suitable for ISR-S400)

*The actual value may be slightly different

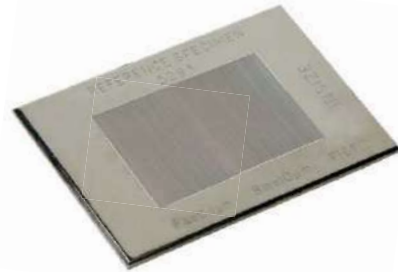

ISR-RS529X

SHOT AND GRIT BLASTING SURFACE ROUGHNESS SPECIMENS

INSIZE PLUS
MADE IN UK

- To check the roughness of steel surfaces which have been blast cleaned before painting
- Meets ISO 8503/1
- Rust-proof, made of pure Nickel
- Each piece contains 4 parts

Code	Machining method	Roughness (Ra)	Roughness (Rz)
ISR-CS017	Shot blasting	3.2, 8, 13, 18µm	19.2, 48, 78, 108µm
ISR-CS018	Grit blasting	3.2, 10.5, 18, 25µm	19.2, 63, 108, 150µm



ISR-CS017

COATING THICKNESS GAGE

INSIZE PLUS
MADE IN GERMANY

SUITABLE FOR SMALL SURFACES,
CONCAVE OR CONVEX SURFACES

FOR MAGNETIC AND
NON-MAGNETIC SUBSTRATES

connected to probe



main unit
ISO-2000FN



magnetic induction
probe Fe (optional)
ISO-2000FN-FE



eddy current probe
NFe (optional)
ISO-2000FN-NFE



- Suitable for small surfaces, concave or convex surfaces
- Magnetic induction probe (Fe) measures the thickness of non-magnetic coating on magnetic substrate
Substrate: iron, steel, magnetic stainless steel (not for non-magnetic stainless steel)
Coating: zinc, copper, chrome-tin, plastic powder, paint (not for nickel)
- Eddy current probe (NFe) measures the thickness of non-conductive coating on non-magnetic metal substrate
Substrate: copper, aluminum, zinc, non-magnetic stainless steel
Coating: plastic powder, paint, anodizing



standard foils (included)

MAIN UNIT

Code	ISO-2000FN (without probes)	
Measuring range	magnetic induction probe (Fe)	0~2000µm
	eddy current probe (NFe)	0~800µm
Accuracy	±(1.5+2%L)µm L is measuring thickness in µm	
Resolution	0.1µm (range<100µm)	
	1µm (range 100~1000µm)	
	10µm (range≥1000µm)	
Repeatability	1µm (range 0~1000µm)	
	10µm (range≥1000µm)	
Measuring mode	continuous or single	
Calibration mode	four points calibration	
Minimum substrate thickness	magnetic induction probe (Fe): 0.2mm, eddy current probe (NFe): 0.05mm	
Minimum measuring area	5x5mm, calibration should be made on workpiece without coating	
Power supply	2×1.5V AA batteries	
Dimension of main unit	122×65×22mm	
Weight of main unit	150g	

STANDARD DELIVERY

Main unit	1 pc
Zero calibration block for Fe probe	1 pc
Zero calibration block for NFe probe	1 pc
Standard foil	7 pcs
Battery (AA)	2 pcs

PROBE (OPTIONAL)

Magnetic induction probe (Fe)	ISO-2000FN-FE
Eddy current probe (NFe)	ISO-2000FN-NFE

FOR MAGNETIC AND
NON-MAGNETIC SUBSTRATES

DATA
OUTPUT



COATING THICKNESS GAGE CODE 9501-1200



eddy current probe
NFE (optional) with
zero calibration block



magnetic induction
probe FE90 for bores
and grooves (optional)



magnetic induction
probe FE10 with big
range (optional)



zero calibration block
for FE (included)



calibration foils
(included)



data transmission
cable (optional)



magnetic induction
probe FE (included)



software CD
(included)

- Magnetic induction probe (FE) measures the thickness of non-magnetic coating on magnetic substrate
Substrate: iron, steel, magnetic stainless steel (not for non-magnetic stainless steel)
Coating: zinc, copper, chrome, tin, plastic, powder, paint (not for nickel)
- Eddy current probe (NFE) measures the thickness of non-conductive coating on non-magnetic substrate
Substrate: copper, aluminum, zinc, non-magnetic stainless steel
Coating: plastic, powder, paint, anodizing
- Tolerance measurement
- Automatic power off

SPECIFICATION

Probe type	FE (included) magnetic induction probe	NFE (optional) eddy current probe	FE90 (optional) magnetic induction probe for bores and grooves	FE10 (optional) magnetic induction probe with big range
Measuring range	0~1250µm	0~1250µm	0~1250µm	500~10000µm
Accuracy	±(3%L+1)µm (range≤1250µm) ±(3%L+10)µm (range>1250µm)		L is measuring thickness in µm	
Resolution	0.1µm (range<100µm) 1µm (range≥100µm)			
Measuring mode	continuous and single			
Minimum substrate thickness	0.5mm	0.3mm	0.5mm	2mm
Minimum measuring area	Ø7mm	Ø5mm	Ø7mm	Ø40mm
Minimum curvature radius of convex workpiece	1.5mm	3mm	—	10mm
Memory	500			
Output	USB			
Power supply	2×1.5V AA batteries			
Dimension	128×68×32mm			
Weight	340g			

STANDARD DELIVERY

Main unit	1 pc
Magnetic induction probe (FE)	1 pc
Zero calibration block for FE probe	1 pc
Calibration foils (50µm, 100µm, 250µm, 500µm, 1000µm)	1 set
1.5V AA battery	2 pcs
USB cable and software	1 pc

OPTIONAL ACCESSORY

Data transmission cable	9501-1200-SPC
Eddy current probe (NFE) with zero calibration block	9501-1200-NFE
Magnetic induction probe (FE90) for bores and grooves	9501-1200-FE90
Magnetic induction probe (FE10) with big range	9501-1200-FE10

CROSS CUT ADHESION TESTER CODE ISQ-PK100



- To test the adhesion of paint coating on metal, wood, plastic, etc.
- According to ISO 2409, ASTM D3359, DIN53151



1mm pitch blade
(included)



2mm pitch blade
(included)



3mm pitch blade
(included)



2X magnifier
(included)



brush (included)



test tape (included)
ISQ-PK100-1

SPECIFICATION

Blade		1mm pitch	2mm pitch	3mm pitch
Applied paint thickness	on hard substrate (like metal)	0~60μm	61~120μm	121~250μm
	on soft substrate (like wood, plaster)	—	0~120μm	121~250μm
Minimum substrate thickness	hard substrate (like metal)	0.25mm	0.25mm	0.25mm
	soft substrate (like wood, plaster)	—	10mm	10mm
Minimum size of test sample		150×100mm	150×100mm	150×100mm
Dimension		170×28×40mm		
Weight		430g		

STANDARD DELIVERY

Handle	1 pc
1mm pitch blade	1 pc
2mm pitch blade	1 pc
3mm pitch blade	1 pc
Test tape (ISQ-PK100-1)	1 pc
2X magnifier	1 pc
Brush	1 pc



step 1: make grid
cutting on surface



step 2: paste and
remove the tape

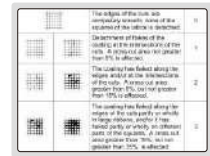

step 3: according to the
shedding status, judge
the adhesion grade

DIGITAL SURFACE PROFILE GAGE

DATA
OUTPUT

DISPLAY MAXIMUM, MINIMUM, DIFFERENCE
VALUE BETWEEN MAXIMUM AND MINIMUM

- Measure peak-to-valley height of blast cleaned surface. If the profile is too low, the adhesion of the coating to the surface will be reduced.
- If the profile is too high, there is the danger that the profile peaks will remain uncoated, allowing rust spots to occur.
- Meet ASTM D 4417-B
- Zero set block is included, set zero before measurement
- Button function: tolerance Go and No-Go display, data preset, measuring direction change, max./min./TIR measurement, inch/metric conversion, absolute/incremental measurement
- CR2032 battery, automatic power off
- Data output
- Stainless steel base
- Optional accessory: data output cable (code 7315-, 7302-, 7305-)



2844-10

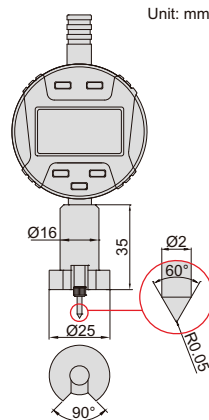

Unit: mm

set zero



zero set block
(included)

measure peak-to-valley height
of blast cleaned surfaces

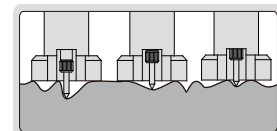

DATA OUTPUT

DIGITAL SURFACE PROFILE GAGE

- Measure peak-to-valley height of blast cleaned surface. If the profile is too low, the adhesion of the coating to the surface will be reduced. If the profile is too high, there is the danger that the profile peaks will remain uncoated, allowing rust spots to occur.
- Meet ASTM D 4417-B
- Zero set block is included, set zero before measurement
- Button function: on/off, zero, mm/inch, absolute/incremental measurement
- CR2032 battery, automatic power off
- Data output
- Stainless steel base
- Optional accessory: data output cable (code 7315-, 7302-, 7305-)



2843-10

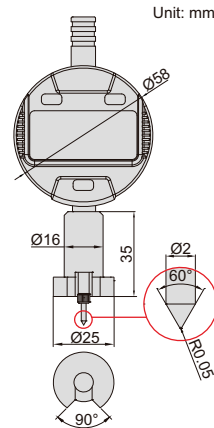

measure peak-to-valley height of blast cleaned surfaces

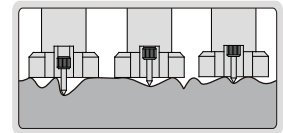

Code	Range	Digital indicator stroke	Digital indicator resolution	Accuracy
2843-10	0-12.7mm/0-0.5"	12.7mm/0.5"	0.001mm/0.00005"	±0.005mm

SURFACE PROFILE GAGE

- Measure peak-to-valley height of blast cleaned surface. If the profile is too low, the adhesion of the coating to the surface will be reduced. If the profile is too high, there is the danger that the profile peaks will remain uncoated, allowing rust spots to occur.
- Meet ASTM D 4417-B
- Zero set block is included, set zero before measurement
- Stainless steel base



2344-1

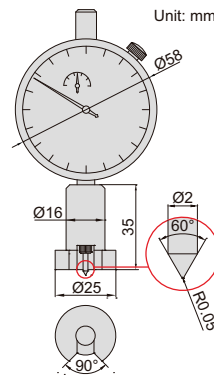

measure peak-to-valley height of blast cleaned surfaces

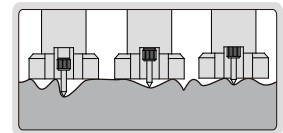

Code	Range	Dial indicator stroke	Dial indicator graduation	Accuracy
2344-1	0-1mm	1mm	0.001mm	±0.005mm

WET FILM GAGES

- Made of stainless steel

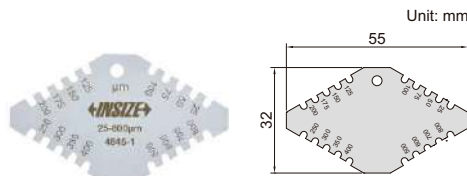

4845-1

4845-1

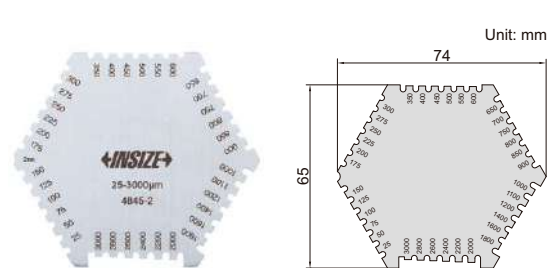

4845-2

4845-2

Code	Range	Accuracy	Thickness
4845-1	25-800µm	±5µm	1.8mm
4845-2	25-3000µm	25-100µm: ±5µm 100µm-3000µm: ±5%	1mm

ULTRASONIC THICKNESS GAGE (THROUGH COATING) CODE ISU-300D

PENETRATE NON-METALLIC COATING AND
MEASURE THE THICKNESS OF METAL SUBSTRATE

INSPECTION
CERTIFICATE

DATA
OUTPUT



- Two measuring modes, Echo-Echo (E-E) and Transmit-Echo (T-E):
 - E-E is applicable for non-metallic coating (such as paint, plastic resin, etc.) on metal substrates, can penetrate coating and measure the thickness of substrates
 - T-E is to measure the thickness of material without coating, such as metal, plastic, glass, nylon, resin, ceramics, ice, etc.
- Tolerance measurement
- Average calculation of maximum 9 readings
- Data can be input to Excel and Word as keyboard signal



SPECIFICATION

Measuring range	E-E mode: coating thickness 0~1mm, substrate thickness 4~25mm
	T-E mode: substrate thickness 1.5~200mm
Resolution	0.01mm (range<100mm) 0.1mm (range≥100mm)
Repeatability	0.03mm (range<100mm) 0.1mm (range≥100mm)
Accuracy	±0.04mm (range<10mm) ±(0.04+H/1000)mm (range 10~100mm) ±H/333mm (range≥100mm) H is the thickness to be measured in mm
Velocity	1000~9999m/s
Power supply	2×1.5V AAA batteries
Dimension	116×64×27mm
Weight	220g

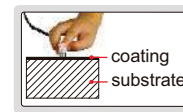

Echo-Echo mode (E-E)

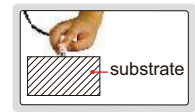

Transmit-Echo mode (T-E)



couplant (included)



transducer ISU-T04 (optional)



transducer ISU-T06 (optional)



transducer ISU-T12 (optional)



transducer ISU-T13 (optional)

STANDARD DELIVERY

Main unit	1 pc
Transducer ISU-T07	1 pc
Battery (AAA)	2 pcs
Couplant (for ISU-T04, ISU-T06, ISU-T07, ISU-T12)	1 bottle
USB cable	1 pc

OPTIONAL ACCESSORY

Transducer	ISU-T04, ISU-T06, ISU-T12, ISU-T13
Couplant (for ISU-T13)	ISU-HT5-COULPLANT

SPECIFICATION OF TRANSDUCERS

Code	Mode	Frequency	Diameter (Ød)	Measuring range	Minimum size of pipe for measurement (diameter × wall thickness)	Applicable temperature	Application
ISU-T07	T-E E-E	5.0MHz	10.8mm	T-E mode: 1.5~200mm E-E mode: 4~25mm	T-E mode: 20×1.2mm E-E mode: 20×4mm	<60°C	general use
ISU-T04	T-E	10.0MHz	6mm	0.7~20mm	10×1mm	<60°C	for small tube
ISU-T06	T-E	7.5MHz	8.5mm	0.7~50mm	15×1.2mm	<60°C	for thin material
ISU-T12	T-E	2.0MHz	16.3mm	2~400mm	30×4mm	<60°C	for casting iron
ISU-T13	T-E	5.0MHz	13mm	2~200mm	25×3mm	<350°C	for high temperature

DATA
OUTPUT

INSPECTION
CERTIFICATE



VIDEO

ULTRASONIC THICKNESS GAGE CODE ISU-250C

- Measure the thickness from one side of object, suitable for pipe, tank, etc.
- Applicable material: metal, plastic, glass, nylon, resin, ceramic, ice
- Tolerance measurement
- Average calculation of 9 readings
- Data can be input to Excel and Word as keyboard signal



couplant (included)



transducer ISU-T04 (optional)



transducer ISU-T06 (optional)



transducer ISU-T12 (optional)



transducer ISU-T13 (optional)

SPECIFICATION

Resolution	0.01mm (range<100mm)
	0.1mm (range≥100mm)
Repeatability	0.03mm (range<100mm)
	0.1mm (range≥100mm)
Accuracy	±0.04mm (range<10mm)
	±(0.04+H/1000)mm (range 10~100mm)
	±H/333mm (range≥100mm)
	H is the thickness to be measured in mm
Velocity	1000-9999m/s
Power supply	2×1.5V AAA batteries
Dimension	64×116×27mm
Weight	220g

STANDARD DELIVERY

Main unit	1 pc
Transducer ISU-T08	1 pc
Battery (AAA)	2 pcs
Couplant (for ISU-T04, ISU-T06, ISU-T08, ISU-T12)	1 bottle
USB cable	1 pc

OPTIONAL ACCESSORY

Transducer	ISU-T04, ISU-T06, ISU-T12, ISU-T13
Couplant (for ISU-T13)	ISU-HT5-COUPPLANT

SPECIFICATION OF TRANSDUCERS

Code	Frequency	Diameter (Ød)	Measuring range	Minimum size of pipe for measurement (diameter × wall thickness)	Applicable temperature	Application
ISU-T08	5.0MHz	10.8mm	0.8~300mm	20×1.2mm	<60°C	general use
ISU-T04	10.0MHz	6mm	0.7~20mm	10×1mm	<60°C	for small tubes
ISU-T06	7.5MHz	8.5mm	0.7~50mm	15×1.2mm	<60°C	for thin materials
ISU-T12	2.0MHz	16.3mm	2~400mm	30×4mm	<60°C	for casting iron
ISU-T13	5.0MHz	13mm	2~200mm	25×3mm	<350°C	for high temperature

INSPECTION
CERTIFICATE

ATTENTION: NOT SUITABLE
FOR CASTING WORKPIECES

ULTRASONIC THICKNESS GAGE (BASIC TYPE) CODE ISU-100D

- Measure the thickness from one side of object, suitable for pipe, tank, etc.
- Applicable material: metal, plastic, glass, nylon, resin, ceramic, ice

SPECIFICATION

Measuring range	0.8~300mm	
Resolution	0.01mm (range<100mm)	
	0.1mm (range≥100mm)	
Accuracy	±0.04mm (range<10mm)	
	±(0.04+H/1000)mm (range 10~100mm)	
	±H/333mm (range≥100mm)	
	H is the thickness to be measured in mm	
Transducer	frequency	5MHz
	diameter (Ød)	10.8mm
Minimum size of pipe for measurement	20×1.2mm (diameter × wall thickness)	
Applicable temperature	<60°C	
Velocity	1000-9999m/s	
Power supply	2×AAA batteries	
Dimension	114×64×28mm	
Weight	200g	



VIDEO



STANDARD DELIVERY

Main unit	1 pc
Transducer	1 pc
Couplant	1 bottle
Battery (AAA)	2 pcs

LASER DISTANCE METERS



- Large display with backlight
- Unit: m, ft, in
- Distance, area, volume and height measurement
- Continuous measuring mode to track maximum and minimum value
- Memory of 99 measurement values
- Automatic power off: laser 20s, main unit 150s

9561-80

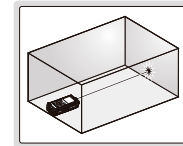

distance measurement

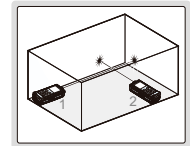

area measurement

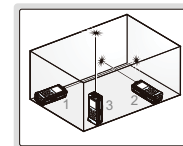

volume measurement

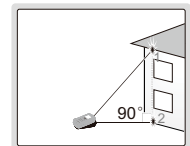

height measurement

SPECIFICATION

Code	9561-40	9561-80
Measuring range	0.05~40m	0.05~80m
Accuracy	±3mm	
Resolution	1mm, 10mm, 0.1", 0.01ft	
Measuring speed	0.5 second	
Laser type	635nm, class II, <1mW	
Power supply	3×AAA batteries, for 4000 measurements	
Dimension (L×W×H)	120×60×28mm	
Weight	175g	

STANDARD DELIVERY

Main unit	1 pc
Battery (AAA)	3 pcs

INFRARED THERMOMETER CODE 9120-550



- With maximum reading
- Tolerance measurement
- Automatic power off



SPECIFICATION

Measuring range	-30~550°C/-22~1022°F
Accuracy	-30~0°C (-22~32°F): ±3°C 0~550°C (32~1022°F): ±(1.5%+2°C)
Resolution	0.1°C/0.1°F
Distance to spot ratio (D:S)	12:1
Emissivity	0.1~1 (adjustable)
Laser type	630~670nm, class II, <1mW
Response time	<0.5s
Power supply	2×1.5V AAA batteries
Dimension	155×110×45mm
Weight	126g (without batteries)

STANDARD DELIVERY

Main unit	1 pc
1.5V AAA battery	2 pcs

front view



IP43
WATERPROOF

DATA
OUTPUT

INFRARED THERMAL CAMERA (BASIC TYPE) CODE 9131-B350

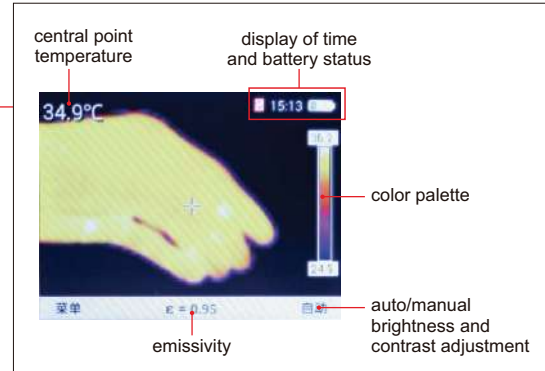

- Easy to use
- Four image presentations: IR, visible, PIP and MIF
- WIFI real-time sharing, one-click connection to mobile devices
- USB interface for data transmission and charging

SPECIFICATION

IR resolution	160×120
NETD	≤50mk
Focus length	5mm/F1.2
Angle of view	30°×23°
Spatial resolution	3.30mrad
Focus adjustment	fixed
Detector type	unrefrigerated vanadium oxide/8~14μm
Pixel size	17μm
Visible camera	resolution 640×480, automatic focus
Display	3.5" highlight LCD screen, 320×240
Image mode	IR image, visible image, MIF, PIP
Digital zoom	x2, x4
Color palette	6 modes
Temperature range	-20°C~350°C
Accuracy	±2°C or ±2% (of maximize range)
Emissivity	0.01-1.00 (adjustable)
Storage	SD card (16G)
Image format	JPG with temp info
Output	USB
Power	rechargeable Li-ion battery, working time≥4h
Operating temperature	-10°C~50°C
Operating humidity	10%~95%RH
Vibration	10HZ~150HZ~10HZ 0.15mm (IEC 60068-2-6)
Impact	30g (IEC 60068-2-27)
Weight	740g
Dimension	258x98x90mm



STANDARD DELIVERY

Main unit	1 pc
Power supply adapter	1 pc
USB cable	1 pc
16G SD card	1 pc

INFRARED THERMAL CAMERA CODE 9130-H360

IP54
WATERPROOF

DATA
OUTPUT

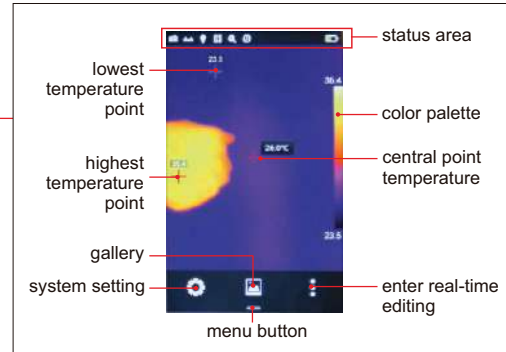

- 4 inch high-brightness touchscreen
- Four image presentations: IR, visible, PIP and MIF
- WIFI real-time sharing, one-click connection to mobile devices
- USB interface for data transmission and charging
- Built-in illumination
- Video can be recorded and stored

SPECIFICATION

IR resolution	192×144
NETD	≤50mk
Focus length	7mm/F1.1
Angle of view	37.8°×28.8°
Spatial resolution	3.45mrad
Focus adjustment	focus-free
Detector type	unrefrigerated vanadium oxide/8~14μm
Pixel size	25μm
Visible camera	resolution 500W, focus-free
Display	4" highlight LCD touch screen, 480×800
Image mode	IR image, visible image, MIF, PIP
Digital zoom	1.1~4
Color palette	8 modes
Temperature range	-20°C~350°C
Accuracy	±2°C or ±2% (of maximize range)
Emissivity	0.01-1.00 (adjustable)
Storage	in camera and TF card (up to 32GB)
Image format	JPG with temp info
Output	USB, HDMI
Power	rechargeable Li-ion battery (7.4V), working time≥4h
Operating temperature	-10°C~50°C
Vibration	10HZ~150HZ~10HZ 0.15mm (IEC 60068-2-6)
Impact	30g 11ms (IEC 60068-2-27)
Weight	735g
Dimension	274x97x78mm



STANDARD DELIVERY

Main unit	1 pc
Power supply adapter	1 pc
USB cable	1 pc
HDMI cable	1 pc
Capacitive screen gloves	1 pc
TF card (16GB)	1 pc

DATA OUTPUT

- Measure velocity, flow, temperature and relative humidity
- Velocity unit: m/s, km/h, mil/h, ft/m, ft/s, knots
- Flow unit: CMS (cubic meter per second), CMM (cubic meter per minute), CFM (cubic feet per minute)
- Temperature type: ambient, dew point, wet bulb
- Maximum and minimum modes
- Automatic power off



VIDEO



software CD (included)

**DIGITAL ANEMOMETER
CODE 9331-40**



SPECIFICATION

Measuring range	velocity	0.8~30m/s, 1.4~108km/h, 0.9~67.2mil/h, 1.3~98.5ft/s, 78~5900ft/m, 0.8~58.3knots
	flow	0~9999CMS, 0~99990CMM, 0~99990CFM
	temperature	-20~60°C/-4~140°F
	relative humidity	0~100%RH
Accuracy	velocity	±(2%+0.5) for m/s, km/h, mil/h, ft/s, knots ±(2%+50) for ft/m
	temperature	±1.5°C/±2.7°F
	relative humidity	±3% (20~80%RH), ±5% (<20%RH or >80%RH)
Resolution	velocity	0.01m/s, 0.01km/h, 0.01mil/h, 0.01ft/s, 1ft/m, 0.01knots
	flow	0.01CMS, 0.1CMM, 0.1CFM
	temperature	0.1°C/0.1°F
	relative humidity	0.1%RH
Flowing area range	0~9.999m²/0~9.999ft²	
Sampling time	0.4s	
Maximum working altitude	2000m	
Output	USB	
Power supply	9V battery	
Dimension	165×85×38mm	
Weight	200g	

STANDARD DELIVERY

Main unit	1 pc
USB cable and software	1 pc
9V battery	1 pc

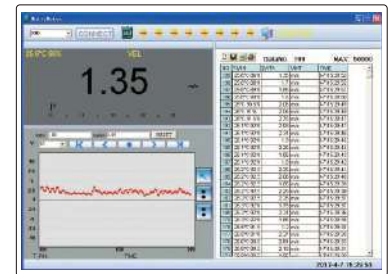

software (included), display measurement values and graph, save and output data

- Suitable for wood, smooth cement, hard gypsum, mixed mortar, brick, etc.
- Measure moisture, temperature and relative humidity
- Temperature type: ambient, dew point, wet bulb
- Maximum and minimum modes
- Automatic power off



VIDEO

**DIGITAL MOISTURE METER
CODE 9341-50**



cover (included)

SPECIFICATION

Measuring depth	0~50mm	
Measuring range	Moisture	0~60%
	temperature	-10~50°C/14~122°F
	relative humidity	0~100%RH
Accuracy	Moisture	±2%
	temperature	±2%
	relative humidity	±5%RH
Resolution	Moisture	0.1%
	temperature	0.1°C/0.1°F
	relative humidity	0.1%RH
Sampling time	0.5s for moisture 1s for temperature and relative humidity	
Power supply	2×AAA batteries	
Dimension	130×56×29mm	
Weight	206g	



STANDARD DELIVERY

Main unit	1 pc
Battery (AAA)	2 pcs

DIGITAL SOUND LEVEL METER CODE 9351-130

- Automatically select best range: 30~80dB, 40~90dB, 50~100dB, 60~110dB, 70~120dB, 80~130dB
- Over range indicator
- Real time, average, maximum modes
- Memory 16000 measurement values
- AC signal output: 0.707 Vrms at FS, impedance approx. 600Ω
- DC signal output: 10mV/dB, impedance approx. 100Ω
- Automatic power off

SPECIFICATION

Measuring range	30~130dB
Accuracy	±2dB
Resolution	0.1dB
Sampling time	0.5s for digital, 0.05s for analogue
Response time	fast: 125ms, slow: 1s
Frequency	30Hz~8KHz
Frequency weighting	A/C
Microphone	electret condenser type
Output	RS232, AC/DC
Power supply	6×AAA batteries
Dimension	265×80×69mm
Weight	317g



software CD
(included)



VIDEO

DATA
OUTPUT

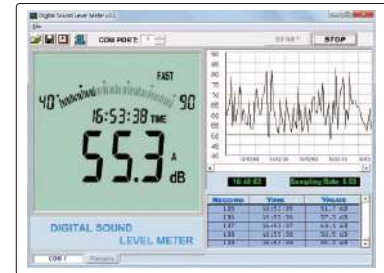

software (included), display measurement values and graph, save and output data

STANDARD DELIVERY

Main unit	1 pc
RS232 cable and software	1 pc
Output connector	1 pc
Battery (AAA)	6 pcs

NON-CONTACT DIGITAL TACHOMETER CODE 9221-999

- Maximum and minimum modes
- Memory 100 measurement values
- Automatic power off



VIDEO

SPECIFICATION

Measuring range	50~99999RPM
Accuracy	±(0.03%+2) RPM
Resolution	0.01RPM (range 50~99.99RPM)
	0.1RPM (range 100~9999.9RPM)
	1RPM (range 10000~99999RPM)
Measuring distance	50~250mm
Power supply	4×AAA batteries
Dimension	155×60×27mm
Weight	118g



reflection sticker (included)

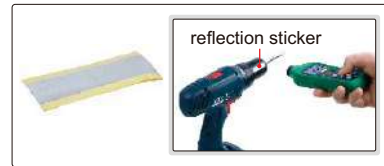

STANDARD DELIVERY

Main unit	1 pc
Reflection sticker	1 roll
Battery (AAA)	4 pcs

CONTACT DIGITAL TACHOMETER CODE 9222-199

- Unit: RPM, m/min, m/sec, ft/min, ft/sec, in/min
- Maximum and minimum modes
- Memory 100 measurement values
- Automatic power off



wheel with 0.1m
perimeter
included)



wheel with 6"
perimeter
(included)



cone cavity
head (included)



cone head
(included)



Extension rod
(included)



VIDEO



SPECIFICATION

Measuring range	50~19999RPM
Accuracy	±(0.03%+2) RPM
Resolution	0.01RPM (range 50~99.99RPM)
	0.1RPM (range 100~9999.9RPM)
	1RPM (range 10000~19999RPM)
Power supply	4×AAA batteries
Dimension	183×60×27mm
Weight	122g

STANDARD DELIVERY

Main unit	1 pc
Wheel with 0.1m perimeter	1 pc
Wheel with 6 inch perimeter	1 pc
Cone cavity head	1 pc
Cone head	1 pc
Extension rod	1 pc
Battery (AAA)	4 pcs



**VIBRATION PEN
CODE 9720-199**

- Measure vibration of motors, fans, pumps, compressors and machine tools to prevent mechanical failure
- Small size, light weight, low energy consumption, easy operation, easy to carry
- One key control
- Automatic power off



SPECIFICATION

Code	9720-199
Measured parameter	speed
Measuring range	0.1~199.9mm/s
Frequency	10Hz~1KHz
Accuracy	±(5%±2)mm/s
Operating temperature	0°C~40°C
Operating humidity	<85%
Power supply	2×LR44 batteries (for 10 hours wroking)
Dimension	150x22x18mm
Weight	55g

STANDARD DELIVERY

Main unit	1 pc
LR44 battery	2 pcs



**PEN-TYPE DIGITAL MULTIMETER
CODE 9241-ML200**

- Auto/manual ranging
- Maximum mode
- Data hold
- Low battery display
- Auto power off
- Safety rating: CAT III 600V



probe (included)



clips (included)



SPECIFICATION

Function	Range	Resolution	Accuracy
DC Voltage	200mV/2V/20V/200V/600V	0.1mV/1mV/10mV/0.1V/1V	±(0.7%+2)
AC Voltage	200mV/2V/20V/200V	0.1mV/1mV/10mV/0.1V	±(0.8%+3)
	600V	1V	±(1.0%+3)
DC Current	20mA/200mA	10µA/0.1mA	±(1.5%+3)
AC Current	20mA/200mA	10µA/0.1mA	±(2.0%+3)
Resistance	200Ω	0.1Ω	±(1.0%+3)
	2kΩ/20kΩ/200kΩ/2MΩ	1Ω/10Ω/0.1kΩ/1kΩ	±(1.0%+1)
	20MΩ	10kΩ	±(1.0%+5)
Logic level test	<1.5V (green LED on) 1.5~3.5V (green & red LED off) >3.5V (red LED on)		
Diode	open circuit voltage 1.5V		
Continuity buzzer	<50Ω		
Power supply	2×1.5V AAA batteries		

STANDARD DELIVERY

Main unit	1 pc
Probe	1 pc
Clip	2 pcs
1.5V battery	2 pcs

DIGITAL MULTIMETER CODE 9242-ML100

- Data hold
- Display backlight
- Low battery display
- Safety rating: CAT II 600V



probes (included)



SPECIFICATION

Function	Range	Resolution	Accuracy
DC Voltage	200mV/2V/20V/200V	0.1mV/1mV/10mV/0.1V	±(0.5%+3)
	600V	1V	±(0.8%+5)
AC Voltage	200V/600V	0.1V/1V	±(1.2%+10)
DC Current	200µA/2mA	0.1µA/1µA	±(1.0%+3)
	20mA	10µA	±(1.0%+5)
	200mA	0.1mA	±(1.5%+5)
	10A	10mA	±(3.0%+10)
Resistance	200Ω	0.1Ω	±(0.8%+5)
	2kΩ/20kΩ/200kΩ	1Ω/10Ω/0.1kΩ	±(0.8%+2)
	2MΩ	1kΩ	±(1.0%+5)
Diode	open circuit voltage 3.0V		
Continuity buzzer	<70±30Ω		
Transistor hFE	measuring range 0~1000		
Power supply	1×9V 6F22/NEDA 1604 battery		

STANDARD DELIVERY

Main unit	1 pc
Probe	2 pcs
9V battery	1 pc

AC DIGITAL CLAMP METER CODE 9243-CA600

- Auto/manual ranging
- Maximum mode
- Data hold
- Display backlight
- Work light
- Low battery display
- Auto power off
- Safety rating: CAT III 600V



probes (included)



SPECIFICATION

Function	Range	Resolution	Accuracy
DC Voltage	200mV/2V/20V/200V	0.1mV/1mV/10mV/0.1V	±(0.8%+2)
	600V	1V	±(1.0%+2)
AC Voltage	200mV	0.1mV	±(1.0%+10)
	2V/20V/200V	1mV/10mV/0.1V	±(1.0%+5)
AC Current	600V	1V	±(1.2%+5)
	2A(≤0.5A)	1mA	±(3.5%+20)
	2A	1mA	±(3.0%+10)
	20A	10mA	±(3.0%+10)
	200A	0.1A	±(2.5%+10)
Resistance	600A	1A	±(1.5%+5)
	200Ω/2kΩ/20kΩ/200kΩ/2MΩ	0.1Ω/1Ω/10Ω/0.1kΩ/1kΩ	±(1.2%+2)
	20MΩ	10kΩ	±(2.0%+5)
Diode	open circuit voltage 1.5V		
Continuity buzzer	<60Ω		
Power supply	3×1.5V AAA batteries		

STANDARD DELIVERY

Main unit	1 pc
Probe	2 pcs
1.5V battery	3 pcs



VIDEO

60° GLOSS METER CODE ISQ-DG6

- To test the gloss of coating, such as painting, varnish, printing ink, etc.
- To test the material surfaces, such as metal, granite, ceramic, plastic, paper, etc.
- According to ISO 2813, ASTM D2457, ASTM D523
- Automatic power off



base with calibration block (included)

SPECIFICATION

Incidence angle	60°
Measuring range	0~150GU
Resolution	0.1GU
Accuracy	±1.2GU
Repeatability	0.4GU
Zero set error	0.2GU
Measuring area	20×10mm
Power supply	1×1.5V AA battery
Dimension	123×38×65mm
Weight	300g

STANDARD DELIVERY

Main unit	1 pc
Base with calibration block	1 pc
Spare calibration block	1 pc

DATA
OUTPUT



VIDEO

20°/60°/85° GLOSS METER CODE ISQ-DG8



software CD (included)

- To test the gloss of coating, such as painting, varnish, printing ink, etc.
- To test the material surfaces, such as metal, granite, ceramic, plastic, paper, etc.
- According to ISO 2813, ASTM D2457, ASTM D523
- Memory of 10000 measurement results for browsing and output
- Automatic power off



base with calibration block (included)

SPECIFICATION

Incidence angle	20°	60°	85°
Measuring range	0~2000GU	0~1000GU	0~160GU
Resolution	0.1GU (range≤119.9GU) 1GU (range>119.9GU)		
Accuracy	±1.5GU (range≤119.9GU) ±1.5% (range>119.9GU)		
Repeatability	0.2GU (range≤119.9GU) 0.2% (range>119.9GU)		
Zero set error	0.2GU		
Measuring area	10×9mm	16×9mm	39×5mm
Power supply	1×1.5V AA battery		
Dimension	155×48×75mm		
Weight	400g		



software (included), output to Excel

STANDARD DELIVERY

Main unit	1 pc
Base with calibration block	1 pc
USB cable and software	1 pc

SPECTROPHOTOMETER CODE 9710-30



VIDEO

- Concave grating spectrophotometric
- 3.5 inch TFT color LCD, capacitive touch screen, 256 image element double arrays CMOS image sensor
- D/8 geometrical optics, conforms with CIE No.15, GB/T 3978, GB2893, GB/T 18833, ISO7724/1, ASTM E1164, DIN5033 Teil
- Use long life and low power consumption combined LED light source
- Camera locating function, switchable 8mm/4mm aperture, support both SCI and SCE at the same time
- Large capacity storage space, over 20,000 measurement data
- USB port and Bluetooth 4.0
- Two standard observer angles, a variety of illuminant, a variety of color indexes, conforms with a variety of standard colorimetric data,
- Measure sample spectra, accurate Lab data, can be used in color matching and accurate color transmission



DATA OUTPUT

CONCAVE GRATING SPECTROPHOTOMETRIC

Ø8/4mm DUAL APERTURE

BLUETOOTH



software CD (included)



white and black calibration cavity (included)



printer (optional)

SPECIFICATION

Optical geometry	reflect: di: 8°, de: 8° (diffused illumination, 8-degree viewing angle)
Integrating sphere size	Ø48mm
Light source	combined LED light, UV light
Spectrophotometric mode	concave grating
Sensor	256 image element double array CMOS image sensor
Wavelength range	400~700nm
Wavelength interval	10nm
Semiband width	10nm
Measured reflectance range	0~200%
Measuring aperture	dual aperture: MAV: Ø8mm; SAV: Ø4mm
Specular component	SCI&SCE
Color space	CIE LAB, XYZ, Yxy, LCh, CIE LUV, Hunter LAB
Color difference formula	ΔE^*ab , ΔE^*uv , ΔE^*94 , ΔE^*cmc (2:1), ΔE^*cmc (1:1), ΔE^*00v , ΔE (Hunter)
Other colorimetric index	WI (ASTM E313, CIE/ISO, AATCC, Hunter), YI (ASTM D1925, ASTM 313), Metamerism index MI, Staining fastness, Color fastness, Colorstrength, Opacity
Observer angle	2°/10°
Illuminant	A, C, D50, D55, D65, D75, F1, F2, F3, F4, F5, F6, F7, F8, F9, F10, F11, F12, CWF, U30, T183, T184, U35
Displayed data	spectrogram/values, samples chromaticity values, color difference values/graph, PASS/FAIL result, color offset
Measuring time	2.6s
Repeatability	spectral reflectance
	colorimetric values
Inter-instrument error	MAV/SCI: $\Delta E^* \leq 0.15$
Measurement mode	single measurement, average measurement
Data port	USB, Bluetooth 4.0
Data storage	standard 1000 pcs, sample 28000 pcs
Illuminant life span	5 years, more than 3 million times measurements
Battery	Li-ion battery, 5000 measurements within 8 hours
Dimension	184×77×105mm
Weight	600g

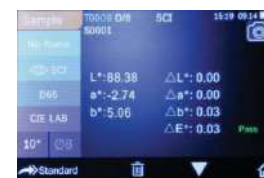

measurement



reflectivity

software

report

measurement data is exported to EXCEL

software (included), test can be controlled from the software, display test data, report

STANDARD DELIVERY

Main unit	1 pc
White and black calibration cavity	1 pc
USB cable and software	1 pc
AC/DC adapter	1 pc

OPTIONAL ACCESSORY

Printer	9710-PRINTER
Powder test box	9710-POWDER
Universal test kit	9710-TEST

DIGITAL LED TACHOMETER/STROBOSCOPE CODE ISQ-TS120K

proximity trigger (included)



- Make cyclical motion (rotation, vibration, etc.) objects to appear slow-moving or stationary
- On-line inspection or observation for moving objects
- Measure the rotation or vibration speed and frequency
- Can be triggered from outside by moving objects, make LED flash frequency same as the rotation or vibration



SPECIFICATION

Flash frequency range	60~120000FPM (Flash Per Minute), 1~2000Hz	
Resolution	FPM	0.1FPM (<100000FPM), 1FPM (≥100000FPM)
	HZ	0.01Hz (<200Hz), 0.1Hz (≥200Hz)
Setting accuracy	±0.01%	
Phase shift increment	3°	
Flash pulse duration time	0.1~2.5°	
LED light	3 pcs CREE 10W lamp	
LED life	3~5 years	
Trigger mode	internal and external	
Power supply	built-in rechargeable battery or AC/DC adapter	
Dimension	208×70×60mm	
Weight	380g	

STANDARD DELIVERY

Main unit	1 pc
AC/DC adapter	1 pc
Proximity trigger	1 pc

SUITABLE FOR WATER
BASED COOLANT

PORTABLE REFRACTOMETER CODE ISQ-RM30



- Quickly measure the concentration of coolant
- Refer to the refraction factor of coolant, for example: the refraction factor of grinding emulsion is 2.1, the reading value is 6%, so the actual concentration is $(2.1 \times 6\%) = 12.6\%$

SPECIFICATION

Measuring range	0~32%
Graduation	0.2%
Dimension	27×40×160mm
Weight	175g



STROKE COUNTER CODE 7600-6

- Accumulate and record the number of mechanical movements
- Rotate back to zero

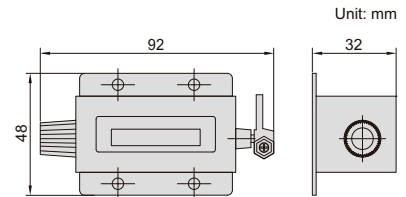

SPECIFICATION

Code	Number of digits	Range
7600-6	6	0-999999

DIGITAL LEVEL CODE ISE-2DT

DATA
OUTPUT

- Color LCD, touch panel
- X-Y axis measurement
- Set the tolerance and the display is shown in different colors

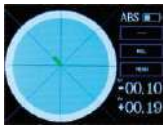

within the tolerance (green)

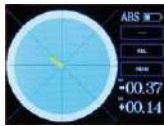

slightly out of the tolerance (yellow)

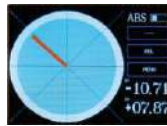

seriously out of the tolerance (red)

- To show the incline with line or bubble

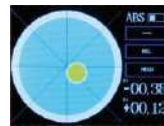
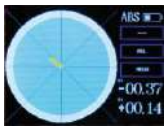

21

22

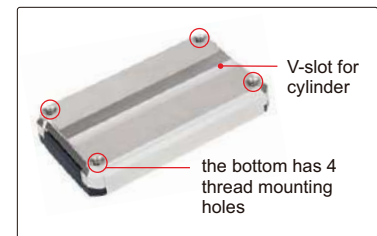
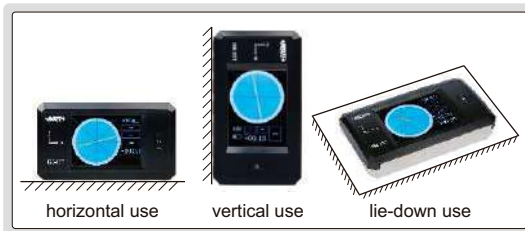

SPECIFICATION

Measuring range	$\pm 30^\circ$
Resolution	0.01°, 0.1mm/m
Accuracy	$\pm 0.03^\circ$ (range 0~3°) $\pm 0.05^\circ$ (range >3°)
Power supply	rechargeable battery
Dimension	115×66×23mm
Weight	224g

STANDARD DELIVERY

Main unit	1 pc
USB cable	1 pc

OPTIONAL ACCESSORY

Software	ISE-2DT-SOFTWARE
----------	------------------

IP67
WATERPROOF

ABSOLUTE
LEVEL

BACKLIGHT

BUZZER ALARM
AT 0° AND 90°

WORKING TEMPERATURE
-5°C ~ 50°C

DIGITAL LEVEL AND SLOPE METER

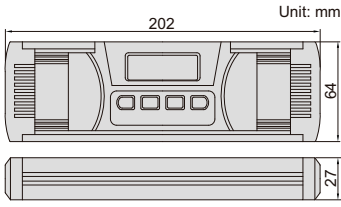

2175-360

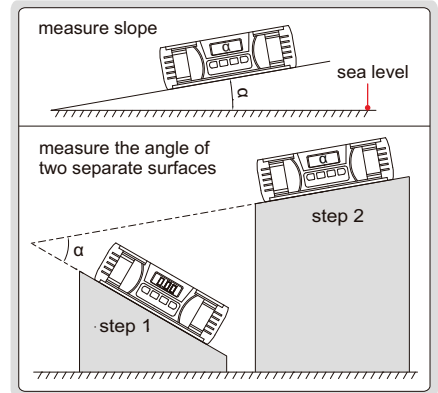

- IP67 dust/waterproof
- Aluminum frame, shock absorbing rubber end caps
- Magnetic bottom with V-groove for shafts
- The sea level is permanently set inside the chip, zero setting is not needed when batteries are replaced
- Buttons: ON/OFF, backlight/buzzer alarm, absolute and incremental measurement, unit (mm/m, %, °), HOLD (keep the reading)
- Three AAA batteries, automatic power off

Code	Range	Resolution	Accuracy
2175-360	0-360° (90°x4)	0.05° (=0.873mm/m)	at 0°: ±0.05°; at others: ±0.1°

IP54
WATERPROOF

ABSOLUTE
LEVEL

BACKLIGHT

BUZZER ALARM
AT 0° AND 90°

WORKING TEMPERATURE
-5°C ~ 50°C

DIGITAL LEVEL AND SLOPE METER

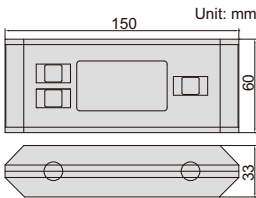

2179-360

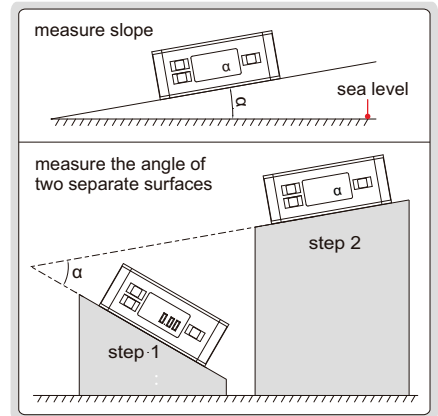

- IP54 dust/waterproof
- Used as level and slope meter
- Aluminum frame
- Magnetic bottom with V-groove for shafts
- The sea level is permanently set inside the chip, zero setting is not needed when battery is replaced
- Buttons: ON/OFF, absolute and incremental measurement, keep the reading, buzzer alarm, unit (mm/m, %, in/ft), conversion, backlight
- Two AAA batteries, automatic power off

Code	Range	Resolution	Accuracy
2179-360	0-360° (90°x4)	0.05° (=0.873mm/m)	at 0° and 90°: ±0.1°; at others: ±0.2°

DISPLAY FLIPS OVER WHEN
THE BOTTOM FACES UP

WORKING TEMPERATURE
-5°C ~ 50°C

BACKLIGHT

ABSOLUTE
LEVEL

MAGNETIC
BOTTOM

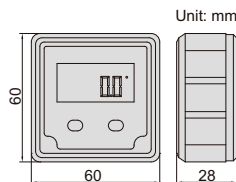

2170-1

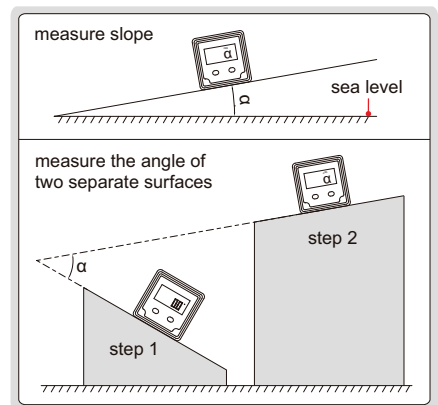

- Used as level and slope meter
- Aluminum frame
- Magnetic bottom
- The display flips over when the bottom faces up
- The backlight is on automatically when in use, and automatically off in 15 minutes after use
- The sea level is permanently set inside the chip, zero setting is not needed when battery is replaced
- Buttons: ON/OFF, ZERO, absolute and incremental measurement
- One AAA battery, automatic power off in 5 minutes

Code	Range	Resolution	Accuracy
2170-1	4x90°	0.1° (=1.745mm/m)	at 0° and 90°: ±0.1°; at others: ±0.2°

FRAME LEVELS

INSIZE PLUS
MADE IN GERMANY

- No need to set zero before use
- Three V-grooves for shafts (shafts dia. 19.3~115.9mm)
- With longitudinal vial

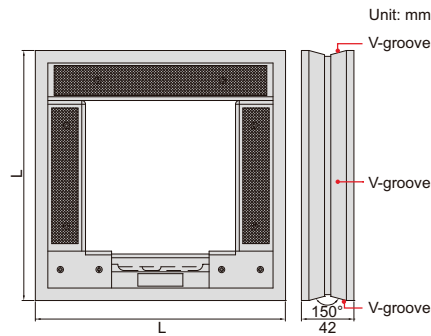

NO NEED TO SET ZERO BEFORE USE



4906-200

Code		Size (LxL)
Sensitivity 0.02mm/m (=0.001°)	Sensitivity 0.1mm/m (=0.0057°)	
4906-150	4906-B150	150x150mm
4906-200	4906-B200	200x200mm
4906-300	4906-B300	300x300mm

FRAME LEVELS (ECONOMIC TYPE)



- V-groove on bottom and left for shafts (shafts dia. 15~70mm)
- With transverse vial
- Supplied with adjusting wrench

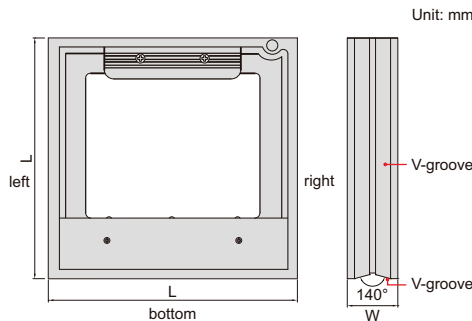

4902-200

Code		Size (LxL)	W
Sensitivity 0.02mm/m (=0.001°)	Sensitivity 0.05mm/m (=0.0029°)		
4902-150	4902-C150	150x150mm	40mm
4902-200	4902-C200	200x200mm	40mm
4902-300	4902-C300	300x300mm	45mm

BLOCK LEVELS

INSIZE PLUS
MADE IN GERMANY

- No need to set zero before use
- V-groove on bottom for shafts (shafts dia. 19.3~115.9mm)
- With longitudinal vial



4905-200

NO NEED TO SET ZERO BEFORE USE

Code		Size (L)
Sensitivity 0.02mm/m(=0.001°)	Sensitivity 0.1mm/m(=0.0057°)	
4905-160	4905-B160	160mm
4905-200	4905-B200	200mm
4905-300	4905-B300	300mm
4905-500	4905-B500	500mm

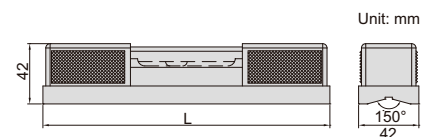

BLOCK LEVELS (ECONOMIC TYPE)



4903-200A

- V-groove on bottom for shafts (shafts dia. 15~70mm)
- With transverse vial
- Supplied with adjusting wrench

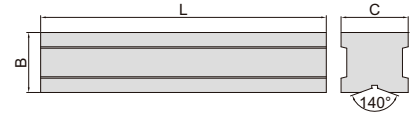

Code		Length (L)	B	C
Sensitivity 0.02mm/m (=0.001°)	Sensitivity 0.05mm/m (=0.0029°)			
4903-150A	4903-C150	150mm	40mm	45mm
4903-200A	4903-C200	200mm	42mm	47mm
4903-300A	4903-C300	300mm	45mm	50mm

NO NEED TO SET ZERO BEFORE USE

- No need to set zero before use
- Suitable for small spaces like crankshaft
- Longitudinal and transverse V-grooves on bottom for shafts (shafts dia. 19.3~115.9mm)
- With transverse vial



4907-90

SHORT LEVEL

INSIZE PLUS
MADE IN GERMANY

Code	Length	Sensitivity
4907-90	90mm	0.1mm/m (=0.0057°)

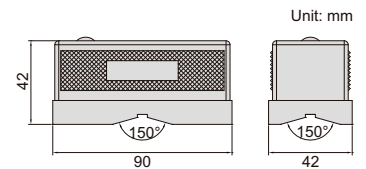

NO NEED TO SET ZERO BEFORE USE

- No need to set zero before use
- With mounting holes (for M5 screws)



4908-100

MINI LEVEL

INSIZE PLUS
MADE IN GERMANY

Code	Length	Sensitivity
4908-100	100mm	0.1mm/m (=0.0057°)

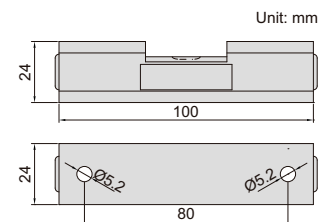

MACHINISTS' LEVELS

- With transverse and longitudinal vials
- V-groove on bottom for shafts (shafts dia. 15-60mm for 4904-150, and 15-70mm for 4904-200/300)
- Supplied with adjust wrench



4904-200

rotate cover to protect vials



Code	Sensitivity	Size (L)	a	b
4904-150	0.3mm/m (=0.017°)	150mm	116mm	58mm
4904-200	0.3mm/m (=0.017°)	200mm	135mm	73mm
4904-300	0.3mm/m (=0.017°)	300mm	216mm	73mm

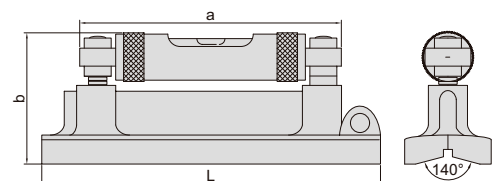

DIGITAL LEVELS AND SLOPE METERS

ABSOLUTE LEVEL

BACKLIGHT

WORKING TEMPERATURE
0°C ~ 50°C

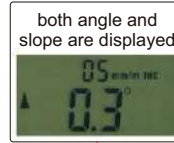
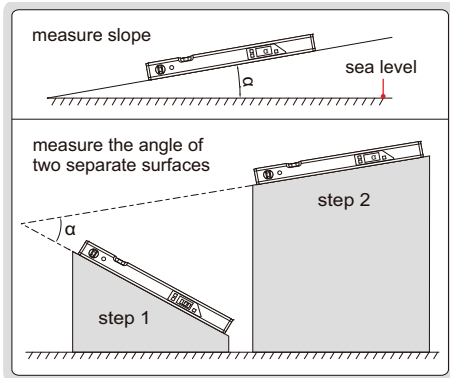

4910-400



4910-600

- With transverse and longitudinal vials
- Used as level and slope meter
- Aluminum frame, magnetic bottom
- The sea level is permanently set inside the chip, zero setting is not needed when batteries are replaced
- Buttons: ON/OFF, absolute and incremental measurement, keep the reading, buzzer alarm (not for 4910-400), unit (mm/m, %, in/ft), conversion (not for 4910-400), backlight
- The display flips over when the bottom faces up
- Two AAA batteries
- Automatic power off

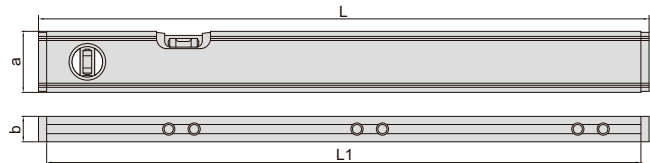

Code	Range	Resolution	Accuracy	Remark	L	L1	a	b
4910-400	0~360° (90°×4)	angle: 0.1°; slope: 1mm/m	±0.2°	both angle and slope are displayed	416	400	50	21
4910-600	0~360° (90°×4)	at 0° and 90°: 0.05° (=0.8725mm/m); at others: 0.1° (=1.745mm/m)	at 0° and 90°: ±0.1°; at others: ±0.2°	at 0° and 90° buzzer alarm	600	585	60	25

(mm)

ALUMINUM ALLOY LEVELS

LIFETIME WARRANTY VIALS

- Top and bottom working surfaces
- Shock-proof and UV-proof vials
- Die casting aluminum alloy frame
- Zero position of horizontal vial can be set
- One graduation of horizontal vial is 2% slope
- Working temperature: -15°C~55°C



4911-600

bottom surface (non-magnetic, milled)



Code	Length (L)	Accuracy
4911-600	600mm	0.5mm/m
4911-800	800mm	0.5mm/m

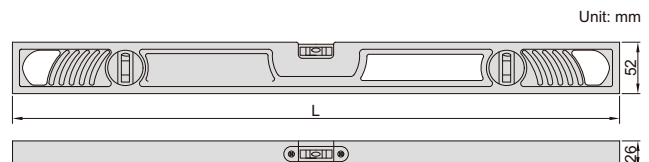

MAGNETIC BASE

LIFETIME WARRANTY VIALS

HANDY LEVEL

magnetic base surface



4912-100

packaging



- Shockproof vials
- Magnetic base
- Shock absorbing rubber end caps
- Working temperature: -15°C~55°C

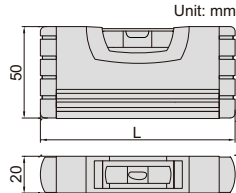

Code	Size (L)	Accuracy
4912-100	100mm	0.5mm/m

MAGNETIC BASE

LIFETIME WARRANTY VIALS

CASTING ALUMINUM LEVEL

magnetic bottom surface (milled)



4913-250

packaging



- Shockproof horizontal and vertical vials
- Magnetic base
- Working temperature: -15°C~55°C
- Casting aluminum body

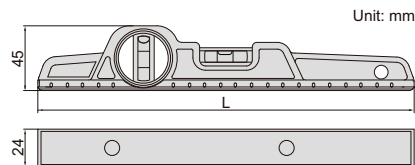

Code	Size (L)	Accuracy
4913-250	250mm	0.5mm/m

LIFETIME WARRANTY VIALS

MAGNETIC BASE

ALUMINUM LEVELS



4914-600

- Shockproof horizontal and vertical vials
- Magnetic base
- Shock absorbing rubber end caps
- Working temperature: -15°C~55°C

magnetic bottom surface (milled)



Code	Size (L)	Accuracy
4914-300	300mm	0.5mm/m
4914-600	600mm	0.5mm/m
4914-800	800mm	0.5mm/m
4914-1000	1000mm	0.5mm/m
4914-1200	1200mm	0.5mm/m
4914-2000	2000mm	0.5mm/m

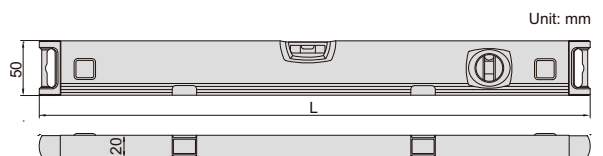

ALUMINUM ALLOY LEVELS (BASIC TYPE)

MAGNETIC BASE

LIFETIME WARRANTY VIALS

- Shock-proof and UV-proof vials
- Magnetic base
- Shock absorbing rubber end caps
- Working temperature: -15°C~55°C



4918-300

Code	Size (L)	Accuracy
4918-300	300mm	1mm/m
4918-600	600mm	1mm/m
4918-800	800mm	1mm/m
4918-1000	1000mm	1mm/m
4918-1200	1200mm	1mm/m
4918-2000	2000mm	1mm/m

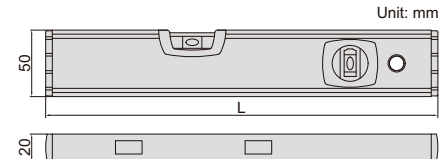
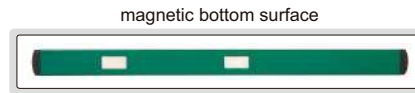

CROSS-LINE LASER LEVEL CODE 4917-30

AUDIBLE AND VISUAL WARNING WHEN OUT OF $\pm 3^\circ$

IP54
WATERPROOF

- Red horizontal and vertical cross laser lines
- Self-leveling within $\pm 3^\circ$, self-leveling time within 4s, audible and visual warning when out of $\pm 3^\circ$
- Folding legs for angle and height adjustment
- Outdoor use can be combined with the detector (code: 4917-DETECTOR)



application examples



folding legs for angle and height adjustment

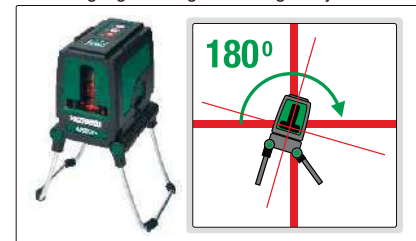

SPECIFICATION

Laser line width	2 \pm 0.5mm (within 5m)
Laser type	630~660nm, class II, <1mW
Beam angle	120 \pm 0.5°
Self-leveling range	$\pm 3^\circ$
Working distance	indoor: 30m, outdoor: 50m with detector (optional)
Accuracy	0.2mm/m
Operation temperature	-10~40°C
Power supply	3 \times AA batteries, for 3 hours working
Dimension	100 \times 82 \times 104mm
Weight	620g

STANDARD DELIVERY

Main unit	1 pc
1/4" to 5/8" tripod adaptor	1 pc
Battery (AA)	3 pcs

OPTIONAL ACCESSORY

Outdoor detector	4917-DETECTOR
------------------	---------------



outdoor detector (optional)

OUTDOOR DETECTOR (OPTIONAL)

Detecting distance	horizontal 1~50m, vertical 1~30m
Detecting accuracy *	high accuracy ± 1.5 mm, low accuracy ± 2.5 mm
Power supply	9V battery
Dimension	168 \times 58 \times 30mm
Weight	140g (battery included)

* Use high accuracy detection mode within 15m, use low accuracy detection mode over 15m

FORCE LOADING BY CLOSE-LOOP SYSTEM (WITHOUT WEIGHT)

AUTOMATIC TESTING, CONTINUOUS TESTING



AUTOMATIC DIGITAL ROCKWELL/SUPERFICIAL ROCKWELL HARDNESS TESTERS (DOLPHIN-NOSE TYPE)

INSPECTION CERTIFICATE

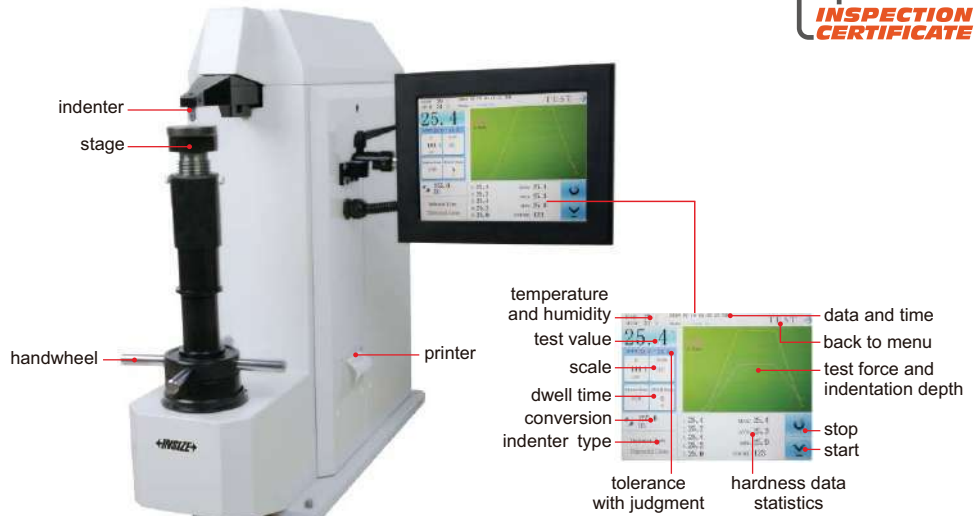

ISHR-T600



The preliminary and total test force are loaded by high speed close-loop system automatically, faster and more stable than traditional motor loading. Loading process is smooth, no overshoot. Loading speed and accuracy are improved greatly

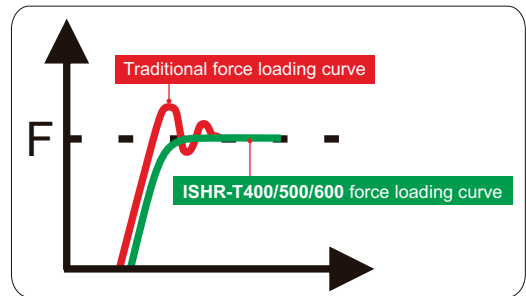

- Automatic testing, the preliminary and total test force are loaded by high speed close-loop system automatically
- Dolphin-nose indenter for easy reach of the internal wall of pipes and grooves, the minimum internal diameter is 40mm
- Can transmit test data to computer
- LCD touch screen
- Tolerance with judgement
- Memory of 120 test values for browsing and output
- Provide the maximum, minimum and average values of measurement
- The test process curve shows the material property
- Test force is selected automatically according to hardness scale

SPECIFICATION

Code	ISHR-T400	ISHR-T500	ISHR-T600
Type	Rockwell	Superficial Rockwell	Rockwell and Superficial Rockwell
Hardness scale	with standard indenters	HRA, HRB, HRC, HRD, HRF, HRG	HR15N, HR30N, HR45N, HR15T, HR30T, HR45T
	with optional indenters	HRE, HRH, HRK, HRL, HRM, HRP, HRR, HRS, HRV	HR15W, HR30W, HR45W, HR15X, HR30X, HR45X, HR15Y, HR30Y, HR45Y
Preliminary test force	Rockwell: 98N (10kg)	Superficial Rockwell: 29.4N (3kg)	Rockwell: 98N (10kg) Superficial Rockwell: 29.4N (3kg)
Total test force	588N (60kg), 980N (100kg), 1471N (150kg)	147.1N (15kg), 294.2N (30kg), 441.3N (45kg)	147.1N (15kg), 294.2N (30kg), 441.3N (45kg), 588N (60kg), 980N (100kg), 1471N (150kg)
Conversion scale	HR, HB, HK, HV		
Stage elevation	manual		
Load control	high speed close-loop system automatic loading (load/dwell/unload)		
Load dwell time	0~99 second		
Resolution	0.1HR		
Data output	built-in printer, RS232		
Max. workpiece height	260mm		
Max. workpiece depth	150mm (from the center of indenter to the main body)		
Power supply	110/220V, 50/60Hz		
Dimension	700×260×700mm		
Weight	85kg		

To be continued

Continued from previous page

STANDARD DELIVERY

Code	ISHR-T400	ISHR-T500	ISHR-T600
Main unit	1 pc	1 pc	1 pc
Ø60mm flat anvil	1 pc	1 pc	1 pc
Ø150mm flat anvil	1 pc	1 pc	1 pc
V-type anvil	1 pc	1 pc	1 pc
Ø1.5875mm carbide ball indenter	1 pc	1 pc	1 pc
Diamond indenter	1 pc	1 pc	1 pc
Hardness test block HRB88~95	1 pc	—	1 pc
Hardness test block HRC20~30	1 pc	—	1 pc
Hardness test block HRC40~50	1 pc	—	1 pc
Hardness test block HRC60~65	1 pc	—	1 pc
Hardness test block 78~88HR15N	—	1 pc	1 pc
Hardness test block 55~73HR30N	—	1 pc	1 pc
Hardness test block 57~69HR30T	—	1 pc	1 pc



Ø60mm flat anvil (included)



Ø150mm flat anvil (included)



V-type anvil (included) for cylinders with diameter Ø4~60mm



small V-type anvil (optional) for cylinders with diameter Ø2~4mm

OPTIONAL ACCESSORY

Hardness test block HRB88~95	ISH-BHRB
Hardness test block HRC20~30	ISH-BHRC1
Hardness test block HRC40~50	ISH-BHRC2
Hardness test block HRC60~65	ISH-BHRC3
Hardness test block 78~88HR15N	ISH-BHR15N1
Hardness test block 55~73HR30N	ISH-BHR30N1
Hardness test block 57~69HR30T	ISH-BHR30T1
Small V-type anvil	ISH-SMALLANVIL
Connection cable and software	ISHR-T-SOFTWARE

AUTOMATIC DIGITAL ROCKWELL/SUPERFICIAL ROCKWELL HARDNESS TESTERS



FORCE LOADING BY ELECTRIC MOTOR (WITHOUT WEIGHT)

DATA OUTPUT

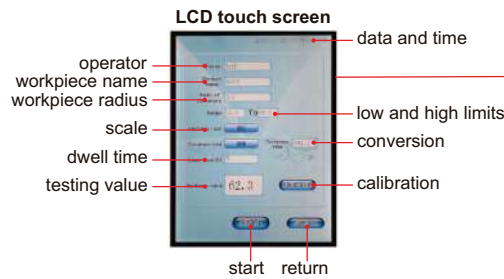

ISH-RSR400

- Automatic testing, the preliminary and main test force are loaded automatically
- LCD touch screen, easy operation
- Convert to other Rockwell scales, HV or HB automatically
- Tolerance testing
- Insert USB flash disk, save the testing results as Excel
- Self-correcting the hardness value for curved workpieces
- Force loading by electric motor (without weights)
- The test force is selected automatically according to hardness scale

To be continued

Continued from previous page



Ø63mm flat anvil
(included)



Ø150mm flat anvil
(included)



level (included)



touch pen (included)



V-type anvil (included)
for cylinders with
diameter Ø4~60mm



small V-type anvil
(optional)
for cylinders with
diameter Ø2~4mm

SPECIFICATION

Code		ISH-RSR400**	ISH-RSR500**	ISH-RSR600**
Type		Rockwell	Superficial Rockwell	Rockwell and Superficial Rockwell
Hardness scale	with standard indenters	HRA, HRB, HRC, HRD, HRF, HRG	HR15N, HR30N, HR45N, HR15T, HR30T, HR45T	HRA, HRB, HRC, HRD, HRF, HRG, HR15N, HR30N, HR45N, HR15T, HR30T, HR45T
	with optional indenter	HRE, HRH, HRK, HRL, HRM, HRP, HRR, HRS, HRV	HR15W, HR30W, HR45W, HR15X, HR30X, HR45X, HR15Y, HR30Y, HR45Y	HRE, HRH, HRK, HRL, HRM, HRP, HRR, HRS, HRV, HR15W, HR30W, HR45W, HR30X, HR45X, HR15Y, HR30Y, HR45Y
Preliminary test force		98N/10kgf for Rockwell	29.4N/3kgf for Superficial Rockwell	98N/10kgf for Rockwell 29.4N/3kgf for Superficial Rockwell
Test force		588N (60kg), 980N (100kg), 1471N (150kg)	147.1N (15kg), 294.2N (30kg), 441.3N (45kg)	147.1N (15kg), 294.2N (30kg), 441.3N (45kg), 588N (60kg), 980N (100kg), 1471N (150kg)
Stage elevation		manual		
Load control		automatic (load/dwell/unload)		
Load dwell time		0~60 second		
Resolution		0.1HR		
Output		USB		
Max. workpiece height		220mm		
Max. workpiece depth		200mm (from the center of indenter)		
Power supply		220V, 50/60Hz**		
Dimension		510×260×780mm		
Weight		70kg		

STANDARD DELIVERY

Code	ISH-RSR400**	ISH-RSR500**	ISH-RSR600**
Main unit	1 pc	1 pc	1 pc
Ø63mm flat anvil	1 pc	1 pc	1 pc
Ø150mm flat anvil	1 pc	1 pc	1 pc
V-type anvil	1 pc	1 pc	1 pc
Diamond indenter	1 pc	1 pc	1 pc
Ø1.5875mm carbide ball indenter	1 pc	1 pc	1 pc
Hardness test block HRB88~95	1 pc	—	1 pc
Hardness test block HRC60~65	1 pc	—	1 pc
Hardness test block HRC20~30	1 pc	—	1 pc
Hardness test block 78~88HR15N	—	1 pc	1 pc
Hardness test block 55~73HR30N	—	1 pc	1 pc
Hardness test block 57~69HR30T	—	1 pc	1 pc
USB flash disk (8G)	1 pc	1 pc	1 pc
Level	1 pc	1 pc	1 pc
Touch pen	1 pc	1 pc	1 pc
Anti-dust cover	1 pc	1 pc	1 pc

** Add "-U" on code No. when power supply is 110V, 50/60Hz

OPTIONAL ACCESSORY

Hardness test block HRB88~95	ISH-BHRB
Hardness test block HRC60~65	ISH-BHRC3
Hardness test block HRC20~30	ISH-BHRC1
Hardness test block 78~88HR15N	ISH-BHR15N1
Hardness test block 55~73HR30N	ISH-BHR30N1
Hardness test block 57~69HR30T	ISH-BHR30T1
Small V-type anvil	ISH-SMALLANVIL

AUTOMATIC DIGITAL ROCKWELL HARDNESS TESTER CODE ISH-MRD200**

INSPECTION
CERTIFICATE

DATA
OUTPUT

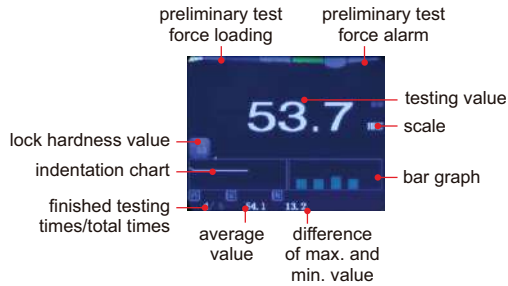

software CD
(included)

- Tolerance testing
- Set testing times (2~10) to have average value and the difference of max. and min. value
- Convert to other Rockwell scales, HV or HB
- Memory of 500 testing values for browsing and output
- Testing value can be sent to wireless printer automatically
- Calibration function compensates the testing value for high accuracy
- The hardness value of soft materials like plastic is not stable, the lock function can obtain the value automatically
- Display unit is automatic power off



Ø60mm flat anvil
(included)



Ø150mm flat anvil
(included)



V-type anvil (included)
for cylinders with diameter
Ø4~60mm



small V-type anvil (optional)
for cylinders with diameter
Ø2~4mm



wireless printer
(optional)

SPECIFICATION

Hardness scale	HRA, HRB, HRC, HRD HRF, HRG (with standard indenters) HRE, HRH, HRK (with optional indenter)
Preliminary test force	98N
Test force	588N, 980N, 1471N
Stage elevation	manual
Load control	automatic (load/dwell/unload)
Load dwell time	1~99 second
Resolution	0.1HR
Output	wireless and USB
Memory	500
Max. workpiece height	170mm
Max. workpiece depth	165mm (from the center of indenter)
Power supply of the display unit	built-in rechargeable battery
Power supply	220V, 50/60Hz **
Dimension	520×160×700mm
Weight	60kg

** Add "U" on code No. when power supply is 110V, 50/60Hz

STANDARD DELIVERY

Main unit	1 pc
Ø60mm flat anvil	1 pc
Ø150mm flat anvil	1 pc
V-type anvil	1 pc
Diamond indenter	1 pc
Ø1.5875mm carbide ball indenter	1 pc
Hardness test block HRB88~95	1 pc
Hardness test block HRC60~65	1 pc
Hardness test block HRC20~30	1 pc
Anti-dust cover	1 pc
USB cable and software	1 pc
AC/DC adapter	1 pc

OPTIONAL ACCESSORY

Wireless printer	ISH-DS-PRINTER
Ø3.175mm carbide ball indenter	ISH-EHK-INDENTER
Hardness test block HRB88~95	ISH-BHRB
Hardness test block HRC60~65	ISH-BHRC3
Hardness test block HRC20~30	ISH-BHRC1
Small V-type anvil	ISH-SMALLANVIL

MANUAL DIGITAL ROCKWELL HARDNESS TESTER CODE ISH-RD200

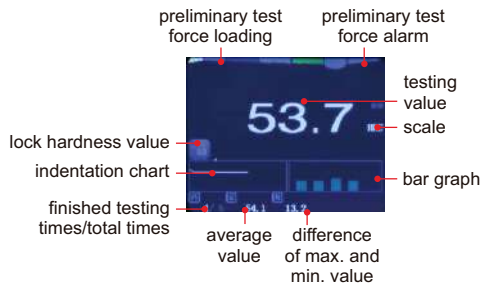

- Tolerance testing
- Set testing times (2~10) to have average value and the difference of max. and min. value
- Convert to other Rockwell scales, HV or HB
- Memory of 500 testing values for browsing and output
- Testing value can be sent to wireless printer automatically
- Calibration function compensates the testing value for high accuracy
- The hardness value of soft materials like plastic is not stable, the lock function can obtain the value automatically
- Automatic power off



Ø60mm flat anvil (included)



Ø150mm flat anvil (included)



V-type anvil (included) for cylinders with diameter Ø4~60mm



small V-type anvil (optional) for cylinders with diameter Ø2~4mm



wireless printer (optional)

SPECIFICATION

Hardness scale	HRA, HRB, HRC, HRD HRF, HRG (with standard indenters) HRE, HRH, HRK (with optional indenter)
Preliminary test force	98N
Test force	588N, 980N, 1471N
Stage elevation	manual
Load control	manual
Resolution	0.1HR
Output	wireless and USB
Memory	500
Max. workpiece height	170mm
Max. workpiece depth	165mm (from the center of indenter)
Power supply	built-in rechargeable battery
Dimension	520×160×700mm
Weight	60kg

STANDARD DELIVERY

Main unit	1 pc
Ø60mm flat anvil	1 pc
Ø150mm flat anvil	1 pc
V-type anvil	1 pc
Diamond indenter	1 pc
Ø1.5875mm carbide ball indenter	1 pc
Hardness test block HRB88~95	1 pc
Hardness test block HRC60~65	1 pc
Hardness test block HRC20~30	1 pc
Anti-dust cover	1 pc
USB cable and software	1 pc
AC/DC adapter	1 pc

OPTIONAL ACCESSORY

Wireless printer	ISH-DS-PRINTER
Ø3.175mm carbide ball indenter	ISH-EHK-INDENTER
Hardness test block HRB88~95	ISH-BHRB
Hardness test block HRC60~65	ISH-BHRC3
Hardness test block HRC20~30	ISH-BHRC1
Small V-type anvil	ISH-SMALLANVIL

AUTOMATIC ROCKWELL HARDNESS TESTER CODE ISH-MR150**



SPECIFICATION

Hardness scale	HRA, HRB, HRC, HRD, HRF, HRG
Preliminary test force	98N
Test force	588N, 980N, 1471N
Display	analogue
Stage elevation	manual
Load control	automatic (load/dwell/unload)
Load dwell time	1~99 second
Min. reading	0.5HR
Max. workpiece height	170mm
Max. workpiece depth	165mm (from the center of indenter)
Power supply	220V, 50/60Hz**
Dimension	520×160×700mm
Weight	60kg

** Add “-U” on code No. when power supply is 110V, 50/60Hz

STANDARD DELIVERY

Main unit	1 pc
Ø60mm flat anvil	1 pc
Ø150mm flat anvil	1 pc
V-type anvil	1 pc
Diamond indenter	1 pc
Ø1.5875mm carbide ball indenter	1 pc
Hardness test block HRB88~95	1 pc
Hardness test block HRC60~65	1 pc
Hardness test block HRC20~30	1 pc
Anti-dust cover	1 pc

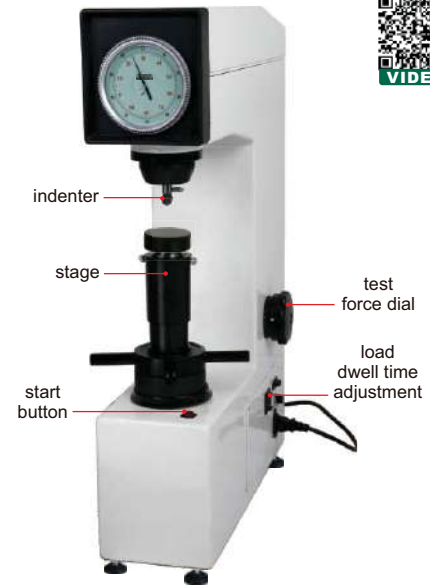

OPTIONAL ACCESSORY

Hardness test block HRB88~95	ISH-BHRB
Hardness test block HRC60~65	ISH-BHRC3
Hardness test block HRC20~30	ISH-BHRC1
Small V-type anvil	ISH-SMALLANVIL

MANUAL ROCKWELL HARDNESS TESTER CODE ISH-R150



SPECIFICATION

Hardness scale	HRA, HRB, HRC, HRD, HRF, HRG
Preliminary test force	98N
Test force	588N, 980N, 1471N
Display	analogue
Stage elevation	manual
Load control	manual
Min. reading	0.5HR
Max. workpiece height	170mm
Max. workpiece depth	165mm (from the center of indenter)
Dimension	520×160×700mm
Weight	60kg

STANDARD DELIVERY

Main unit	1 pc
Ø60mm flat anvil	1 pc
Ø150mm flat anvil	1 pc
V-type anvil	1 pc
Diamond indenter	1 pc
Ø1.5875mm carbide ball indenter	1 pc
Hardness test block HRB88~95	1 pc
Hardness test block HRC60~65	1 pc
Hardness test block HRC20~30	1 pc
Anti-dust cover	1 pc



OPTIONAL ACCESSORY

Hardness test block HRB88~95	ISH-BHRB
Hardness test block HRC60~65	ISH-BHRC3
Hardness test block HRC20~30	ISH-BHRC1
Small V-type anvil	ISH-SMALLANVIL

MANUAL ROCKWELL AND SUPERFICIAL ROCKWELL HARDNESS TESTER CODE HDT-RSR100

SPECIFICATION

Hardness scale	HRA, HRB, HRC, HRD, HRF, HRG, HR15N, HR30N, HR45N, HR15T, HR30T, HR45T
Preliminary test force	29.4N/3kgf for Superficial Rockwell 98N/10kgf for Rockwell
Test force	147N/15kgf, 294N/30kgf, 441N/45kgf, 588N/60kgf, 980N/100kgf, 1471N/150kgf
Display	analogue
Stage elevation	manual
Load control	manual
Min. reading	0.5HR
Max. workpiece height	160mm
Max. workpiece depth	140mm (from the center of indenter)
Dimension	460×240×660mm
Weight	75kg

STANDARD DELIVERY

Main unit	1 pc
Ø60mm flat anvil	1 pc
Ø150mm flat anvil	1 pc
V-type anvil	1 pc
Diamond indenter	1 pc
Ø1.5875mm carbide ball indenter	1 pc
Hardness test block HRB88~95	1 pc
Hardness test block HRC60~65	1 pc
Hardness test block HRC20~30	1 pc
Hardness test block 78~88HR15N	1 pc
Hardness test block 55~73HR30N	1 pc
Hardness test block 57~69HR30T	1 pc
Anti-dust cover	1 pc

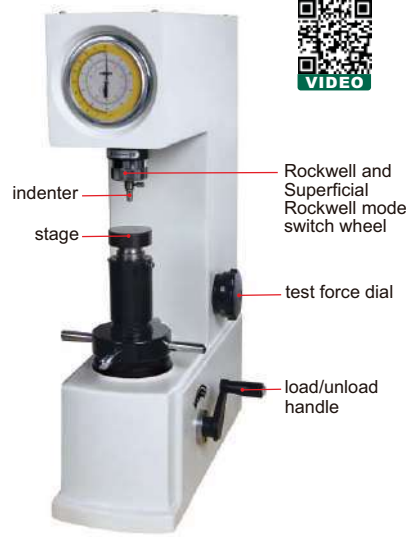

OPTIONAL ACCESSORY

Hardness test block HRB88~95	ISH-BHRB
Hardness test block HRC60~65	ISH-BHRC3
Hardness test block HRC20~30	ISH-BHRC1
Hardness test block 78~88HR15N	ISH-BHR15N1
Hardness test block 55~73HR30N	ISH-BHR30N1
Hardness test block 57~69HR30T	ISH-BHR30T1
Small V-type anvil	ISH-SMALLANVIL

MANUAL ROCKWELL HARDNESS TESTER (BASIC TYPE) CODE HDT-RW160

SPECIFICATION

Hardness scale	HRA, HRB, HRC, HRD, HRF, HRG
Preliminary test force	98N (10kg)
Test force	588N (60kg), 980N (100kg), 1471N (150kg)
Display	analogue
Stage elevation	manual
Load control	manual
Min. reading	0.5HR
Max. workpiece height	170mm
Max. workpiece depth	135mm (from the center of indenter)
Dimension	466×238×630mm
Weight	70kg

STANDARD DELIVERY

Main unit	1 pc
Ø58mm flat anvil	1 pc
Ø150mm flat anvil	1 pc
V-type anvil	1 pc
Diamond indenter	1 pc
Ø1.5875mm steel ball indenter	1 pc
Ø1.5875mm steel ball	5 pcs
Level	1 pc
Hardness test block HRA80~88	1 pc
Hardness test block HRB85~95	1 pc
Hardness test block HRC20~30	1 pc
Hardness test block HRC35~55	1 pc
Hardness test block HRC60~70	1 pc
Anti-dust cover	1 pc

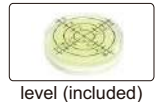

OPTIONAL ACCESSORY

Hardness test block HRA80~88	ISH-BHRA
Hardness test block HRB85~95	ISH-BHRB
Hardness test block HRC20~30	ISH-BHRC1
Hardness test block HRC35~55	ISH-BHRC2
Hardness test block HRC60~70	ISH-BHRC3
Small V-type anvil	ISH-SMALLANVIL

BRINELL/ROCKWELL/VICKERS HARDNESS TESTER

CODE ISH-BRV**



Ø60mm flat anvil for Rockwell (included)



Ø150mm flat anvil for Rockwell (included)



Ø60mm flat anvil for Vickers and Brinell (included)



V-type anvil for Rockwell (included), for cylinders with diameter Ø4~60mm



V-type anvil for Vickers and Brinell (included)



small V-type anvil for Rockwell (optional), for cylinders with diameter Ø2~4mm



SPECIFICATION

Rockwell test load	98N preload, 588, 980, 1471N total load
Min. Rockwell reading	0.5HR
Brinell test load	306, 613, 1839N
Vickers test load	294N
Stage elevation	manual
Load control	manual
Magnification of microscope	37.5X/75X (selectable)
Max. workpiece height	180mm
Max. workpiece depth	200mm (from the center of indenter)
Power supply	220V, 50/60Hz **
Dimension	546×300×767mm
Weight	90kg

** Add “-U” on code No. when power supply is 110V, 50/60Hz

STANDARD DELIVERY

Main unit	1 pc
Ø1.5875mm carbide ball indenter	1 pc
Diamond Rockwell indenter	1 pc
Ø5mm Brinell indenter	1 pc
Ø2.5mm Brinell indenter	1 pc
Vickers indenter	1 pc
Ø60mm flat anvil for Rockwell	1 pc
Ø150mm flat anvil for Rockwell	1 pc
V-type anvil for Rockwell	1 pc
Ø60mm flat anvil for Vickers and Brinell	1 pc
V-type anvil for Vickers and Brinell	1 pc
Hardness test block HRB88~95	1 pc
Hardness test block HRC60~65	1 pc
Hardness test block HRC20~30	1 pc
Hardness test block 400~500HV30	1 pc
Hardness test block 180~200HBW2.5/187.5	1 pc
Anti-dust cover	1 pc

OPTIONAL ACCESSORY

Hardness test block HRB88~95	ISH-BHRB
Hardness test block HRC60~65	ISH-BHRC3
Hardness test block HRC20~30	ISH-BHRC1
Hardness test block 400-500HV30	ISH-BHV30
Hardness test block 180-220HBW2.5/187.5	ISH-BHB25B
Small V-type anvil for Rockwell	ISH-SMALLANVIL

AUTOMATIC DIGITAL BRINELL HARDNESS TESTERS

AUTOMATIC TESTING,
AUTOMATIC TEST FORCE LOADING

FORCE LOADING BY ELECTRIC
MOTOR (WITHOUT WEIGHT)

**INSPECTION
CERTIFICATE**

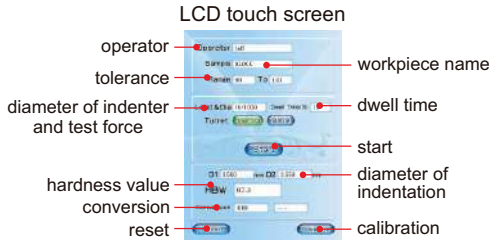

elevate the stage by hand to let the indenter approach the workpiece, press "start" to start testing automatically, the test force is loaded automatically

step: 1



measure indentation with measuring microscope

step: 2



then read the hardness value from LCD

- Automatic testing, automatic test force loading
- LCD touch screen, easy operation
- Measure indentation by measuring microscope then read the hardness value from LCD
- Tolerance testing
- Insert USB flash disk, save the test results as Excel
- Converted to HRA, HRB, HRC, HRD, HRF, HV, HB, HR15N, HR30N, HR45N, HR15T, HR30T, HR45T
- Force loading by electric motor, without weights



Ø80mm flat anvil (included)



Ø200mm flat anvil (included)



V-type anvil (included)



touch pen (included)

SPECIFICATION

Code	ISHB-D200 **	ISHB-D300 **
Turret rotation	manual	automatic
Range	8~650HBW	
Reading mode	directly read from LCD	
Test force	62.5, 100, 125, 187.5, 250, 500, 750, 1000, 1500, 3000kgf	
Max. height of workpiece	200mm	
Max. depth of workpiece	155mm (from the center of indenter)	
Stage elevation	manual	
Load control	automatic (load/dwell/unload)	
Load dwell time	5~60 second	
Measuring microscope	magnification	20X
	resolution	0.625mm
Power supply	220V, 50/60Hz **	
Dimension	550x210x750mm	
Weight	110kg	

** Add "-U" on code No. when power supply is 110V, 50/60Hz

STANDARD DELIVERY

Main unit	1 pc
Ø80mm flat anvil	1 pc
Ø200mm flat anvil	1 pc
V-type anvil	1 pc
Ø2.5mm carbide ball indenter	1 pc
Ø5mm carbide ball indenter	1 pc
USB flash disk (8G)	1 pc
Ø10mm carbide ball indenter	1 pc
Hardness test block 150~250HBW2.5/187.5	1 pc
Hardness test block 75~125HBW10/1000	1 pc
Hardness test block 175~250HBW10/3000	1 pc
Touch pen	1 pc
Anti-dust cover	1 pc

OPTIONAL ACCESSORY

Hardness test block 150~250HBW2.5/187.5	ISH-BHB25B
Hardness test block 75~125HBW10/1000	ISH-BHB10A
Hardness test block 175~250HBW10/3000	ISH-BHB10B
Brinell indentation measuring system	ISHB-TSA/TSB

AUTOMATIC BRINELL HARDNESS TESTER CODE ISHB-M100**

FORCE LOADING BY ELECTRIC MOTOR (WITHOUT WEIGHT)

AUTOMATIC TESTING AFTER PRELIMINARY TEST FORCE IS LOADED BY HAND

INSPECTION
CERTIFICATE

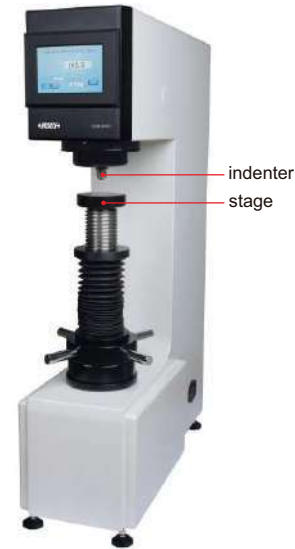
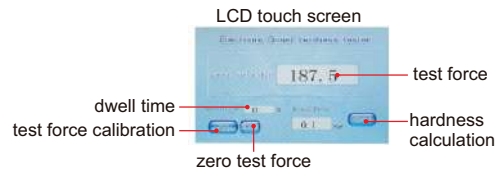

step: 1

measure indentation diameter by measuring microscope

step: 2

input the diameters, the hardness value is shown on screen automatically

- LCD touch screen, easy operation
- Automatic testing after preliminary test force is loaded by hand
- Measure indentation diameter by measuring microscope, input the diameters, the hardness value is shown on screen automatically
- Force loading by electric motor, without weights



Ø80mm flat anvil (included)



Ø200mm flat anvil (included)



V-type anvil (included)



measuring microscope (included)

SPECIFICATION

Range	8~650HBW	
Reading mode	directly read from LCD	
Test force	62.5, 100, 125, 187.5, 250, 500, 750, 1000, 1500, 3000kgf	
Max. height of workpiece	230mm	
Max. depth of workpiece	160mm (from the center of indenter)	
Stage elevation	manual	
Load control	automatic (load/dwell/unload)	
Load dwell time	5~60 second	
Measuring microscope	magnification	20X
	graduation	0.01mm
Power supply	220V, 50/60Hz **	
Dimension	550×210×750mm	
Weight	90kg	

** Add "-U" on code No. when power supply is 110V, 50/60Hz

STANDARD DELIVERY

Main unit	1 pc
Ø80mm flat anvil	1 pc
Ø200mm flat anvil	1 pc
V-type anvil	1 pc
Ø2.5mm carbide ball indenter	1 pc
Ø5mm carbide ball indenter	1 pc
Ø10mm carbide ball indenter	1 pc
Hardness test block 150~250HBW2.5/187.5	1 pc
Hardness test block 75~125HBW10/1000	1 pc
Hardness test block 175~250HBW10/3000	1 pc
Measuring microscope	1 pc
Anti-dust cover	1 pc

OPTIONAL ACCESSORY

Hardness test block 150~250HBW2.5/187.5	ISH-BHB25B
Hardness test block 75~125HBW10/1000	ISH-BHB10A
Hardness test block 175~250HBW10/3000	ISH-BHB10B
Brinell indentation measuring system	ISHB-TSA/TSB

DIGITAL VICKERS HARDNESS TESTERS

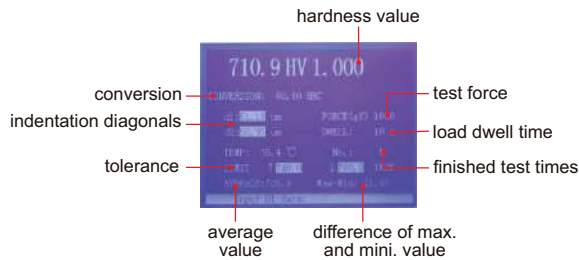

ISH-DV5

- Based on Vickers (HV), can be converted to HRA, HRB, HRC, HRD, HR15N, HR30N, HR45N, HR15T, HR30T, HR45T, HK, HBW
- Can take tests up to 99 times, display average value and the difference of max. and mini. value
- Tolerance testing
- Also for Knoop hardness test, Knoop indenter is needed (optional)

SPECIFICATION

Code	ISH-DV5 **	ISH-DV10 **	ISH-DV50 **
Measuring range	5HV0.2~2500HV5	8HV0.3~2500HV10	5HV1~2500HV50
Test force	0.2, 0.5, 1, 2, 3, 5kgf	0.3, 0.5, 1, 3, 5, 10kgf	1, 5, 10, 20, 30, 50kgf
Accuracy	±3%	±3%	±3% (test force 1, 5, 10, 20kgf) ±2% (test force 30, 50kgf)
Eyepiece	magnification	10X	
	resolution	0.0625µm	
Objective	10X, 20X		
Total magnification	100X (for observation) 200X (for measuring)		
Stage elevation	manual		
Load control	automatic (load/dwell/unload)		
Dwell time	5~60 second		
Max. workpiece height	160mm		
Max. workpiece depth	135mm		
Data output	RS232C		
Power supply	220V, 50/60Hz **		
Dimension	540×270×650mm		
Weight	33kg	35kg	45kg



** Add "-U" on code No. when power supply is 110V, 50/60Hz

STANDARD DELIVERY

Main unit	1 pc
Ø60mm flat anvil	1 pc
Ø150mm flat anvil	1 pc
V-type anvil	1 pc
Vickers indenter	1 pc
10X objective	1 pc
20X objective	1 pc (for ISH-DV5/DV10)
Vickers test block	2 pcs
Anti-dust cover	1 pc

OPTIONAL ACCESSORY

Knoop indenter	ISH-KNOOP
Hardness test block 400~500HV5	ISH-BHV5B
Hardness test block 650~750HV5	ISH-BHV5C
Hardness test block 400~500HV10	ISH-BHV10A
Hardness test block 650~750HV10	ISH-BHV10B
Hardness test block 400~500HV30	ISH-BHV30
Camera adapter	ISH-DV-ADAPTER
Measuring system	9631-130

AUTOMATIC DIGITAL MICRO-VICKERS HARDNESS TESTER CODE ISHV-D120**

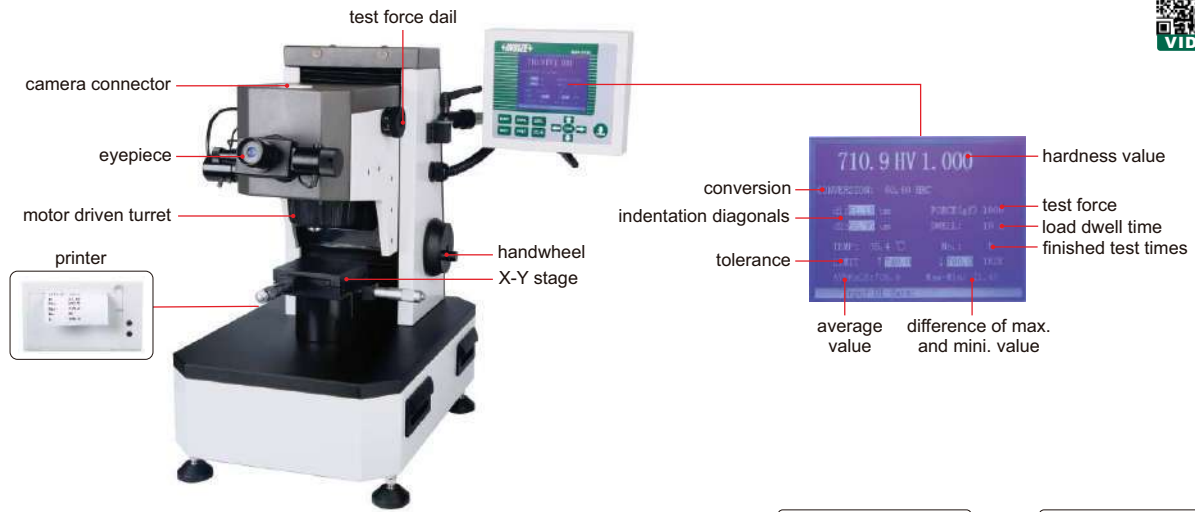

- Based on Vickers (HV), can be converted to HRA, HRB, HRC, HRD, HR15N, HR30N, HR45N, HR15T, HR30T, HR45T, HK, HBW
- Can take tests up to 99 times, display average value and the difference of max. and mini. value
- Tolerance testing
- Also for Knoop hardness test, Knoop indenter is needed (optional)



SPECIFICATION

Range	10~3000HV	
Test force	0.01, 0.025, 0.05, 0.1, 0.2, 0.3, 0.5, 1kgf	
Vickers scales	HV0.01, HV0.025, HV0.05, HV0.1, HV0.2, HV0.3, HV0.5, HV1	
Load control	automatic (load/dwell/unload)	
Load dwell time	0~60 second	
Eyepiece	magnification	10X
	resolution	0.01 μ m (D \geq 10 μ m), 0.001 μ m (D<10 μ m) D is diagonal length of indentation
Objective	10X, 40X	
Total magnification	100X (for observation), 400X (for measurement)	
Max. height of workpiece	210mm	
Max. depth of workpiece	135mm (from the center of indenter)	
X-Y stage	dimension: 100 \times 100mm, travel range: 25 \times 25mm, graduation: 0.01mm	
Power supply	220V, 50/60Hz **	
Dimension	490 \times 320 \times 530mm	
Weight	45kg	

** Add "-U" on code No. when power supply is 110V, 50/60Hz

STANDARD DELIVERY

Main unit	1 pc
Micro Vickers indenter	1 pc
Hardness test block (400~500HV0.2)	1 pc
Hardness test block (700~800HV1)	1 pc
Slice holder	1 pc
Vice	1 pc
Cylinder holder	1 pc
Level	1 pc
Anti-dust cover	1 pc

OPTIONAL ACCESSORY

Hardness test block (400~500HV0.2)	ISH-BHV02A
Hardness test block (700~800HV1)	ISH-BHV1
Knoop indenter	ISHV-D120-KNOOP
Measuring system	9631-130
Camera adapter	ISHV-D120-ADAPTER

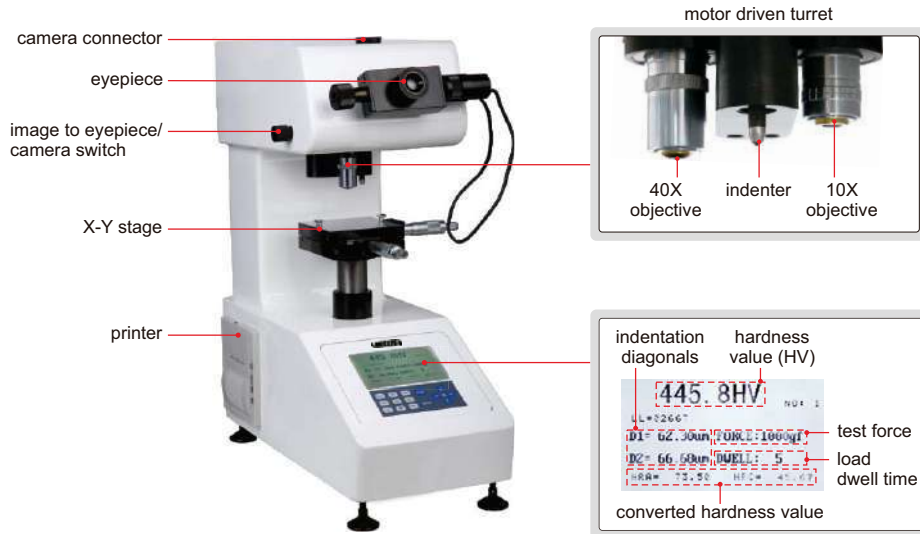

- Measure hardness of thin or small workpieces
- Based on Vickers (HV), can be converted to Rockwell (HRA, HRB and HRC)



cylinder holder (included)



vice (included)



slice holder (included)

SPECIFICATION

Test force	0.01, 0.025, 0.05, 0.1, 0.2, 0.3, 0.5, 1kgf
Vickers scales	HV0.01, HV0.025, HV0.05, HV0.1, HV0.2, HV0.3, HV0.5, HV1
Stage elevation	manual
Load control	automatic (load/dwell/unload)
Load dwell time	5~60 second (5 second increment)
Objective	10X, 40X
Eyepiece	15X
Total magnification	150X (for observation) 600X (for measurement)
Max. workpiece height	85mm
Max. workpiece depth	85mm (from the center of indenter) dimensions: 100×100mm
X-Y stage	travel range: 25×25mm graduation: 0.01mm
Data output	RS232C
Power supply	110/220V, 50Hz**
Dimension	540x500x640mm
Weight	50kg

STANDARD DELIVERY

Main unit	1 pc
10X, 40X objective	1 pc of each
Micro Vickers indenter	1 pc
Hardness test block (400~500HV0.2)	1 pc
Hardness test block (700~800HV1)	1 pc
Slice holder	1 pc
Vice	1 pc
Cylinder holder	1 pc
Level	1 pc
Anti-dust cover	1 pc

OPTIONAL ACCESSORY

20X objective	ISH-TDV-20X
Hardness test block (400~500HV0.2)	ISH-BHV02A
Hardness test block (700~800HV1)	ISH-BHV1
Measuring system	9631-130
Camera adapter	ISH-TDV-ADAPTER

** Add "-B" on code No. when power supply is 110/220V, 60Hz

BRINELL INDENTATION MEASURING SYSTEMS



software CD (included)

- Connected to computer USB port
- Automatically measure the indentation
- Result saved to Excel automatically
- Tolerance testing
- Calibration with indentation on standard hardness block



ISHB-TSA

SPECIFICATION

Code	ISHB-TSA	ISHB-TSB
Applicable Brinell indenter	Ø10mm	Ø2.5mm, Ø5mm
Hardness range	8-650HB	
Range of indentation diameter	Ø2.4-6mm	Ø0.6-3mm
Test force	100, 250, 500, 1000, 1500, 3000kgf	62.5, 125, 187.5, 250, 750kgf
Hardness resolution	1HB	
Length resolution	0.01mm	
Length accuracy	±1% (diameter of indentation)	
Camera	Sensor	1/3.2" CMOS
	Pixel	2M (resolution 1024x768)
	View filed	9x6.8mm 4.5x3.4mm
Dimension	170x54x54mm	
Weight	420g	

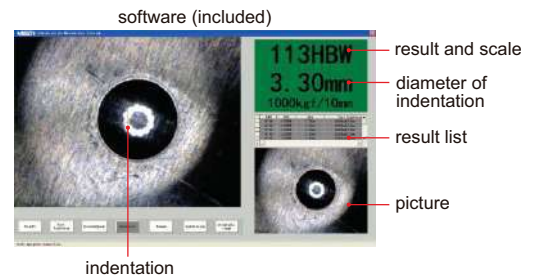

STANDARD DELIVERY

Main unit	1 pc
Software and dongle	1 pc of each

VICKERS HARDNESS MEASURING SYSTEM CODE 9631-130

- Connected to computer USB port
- Measure the indentation sizes automatically or manually
- Multiple measurements to have average value, max. value and min. value
- Tolerance testing
- Convert to HRA, HRB, HRC, HRD, HRE, HRF, HRG, HRK, HR15T/30T/45T, HR15N/30N/45N, HK, HV, HB, HS, HSD
- Calibration with standard test block
- Measurement result can be sent to Word or Excel



software CD (included)

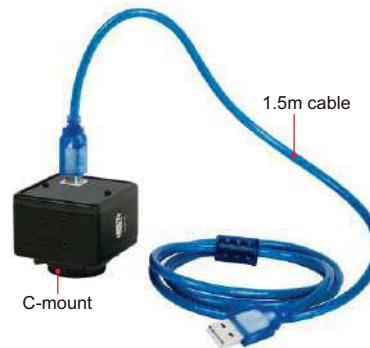

application example



SPECIFICATION

Sensor	1/2" CMOS
Pixel	1.3M (resolution 1280x1024)
Hardness measurement resolution	0.1HV
Length measurement resolution	0.1µm
Hardness measurement accuracy	±3%
Test force	0.01, 0.025, 0.05, 0.1, 0.2, 0.3, 0.5, 1, 2, 2.5, 3, 5, 10, 20, 30, 50, 100kgf
Dimension	57x51x49mm
Weight	200g

STANDARD DELIVERY

Main unit	1 pc
USB dongle	1 pc
USB cable and software	1 pc

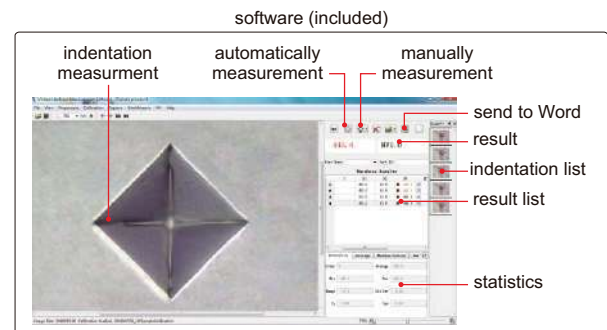

ATTENTION: HARDNESS BLOCKS FOR CALIBRATION ARE OPTIONAL

ATTENTION: NEED TO CONFIRM IF THE WORKPIECES ARE SUITABLE BEFORE PURCHASE

ULTRASONIC HARDNESS TESTER CODE ISHU-330

INSPECTION
CERTIFICATE

DATA
OUTPUT



software CD
(included)

Application:

1. For steel material
2. Test surface hardening layers (carburized, nitriding, high frequency hardened, etc.)
3. Suitable for arc and conical surface
4. Suitable for small or light workpieces
5. Test large workpieces at any direction
6. Suitable for rough surfaces



test flat surfaces
(with the cover)



test cylinder surfaces
(use V-groove
on the cover)



cover

- Small test indentation
- Test force and time are not affected by the operator
- Quick testing, only 2 seconds
- Average and statistics test modes
- Memory of 1024 test results for browsing and output
- Automatic power off
- Anti-dust and waterproof

SPECIFICATION OF MAIN UNIT

Hardness scale		HV, HB, HRC, MPa
Range		100~940HV, 80~650HB, 20~70HRC, 370~1740MPa
Resolution		1HV, 1HB, 0.1HRC, 1MPa
Accuracy	HB	±3%
	HV	±3%
	HRC	±1.5%
Data output		USB
Operating temperature		-20°C ~ +40°C
Power supply		built-in rechargeable battery
Dimension of main unit		120×60×25mm
Weight of main unit		200g

STANDARD DELIVERY

Main unit	1 pc
Probe A	1 pc
Rechargeable battery	2 pcs
Charger	1 pc
USB cable and software	1 pc

SPECIFICATION OF PROBE

Type	A (standard)	B (optional)
Test force	50N	10N (small force)
Application	general use	plating
Maximum roughness of workpiece (Ra)	2.5μm	1.5μm
Minimum weight of workpiece (direct measurement)	0.1kg *	0.1kg *
Minimum thickness of workpiece (direct measurement)	1mm *	1mm *
Minimum radius of workpiece	5mm	5mm
Minimum thickness of surface hardening layer or plating	0.1mm	0.03mm
Minimum test area	Ø1mm	Ø1mm
Dimension and weight of probe	140×Ø37mm, 271g	145×Ø37mm, 271g

*If the weight or thickness of workpiece is less than required, the workpiece should be fixed or coupled on solid support.

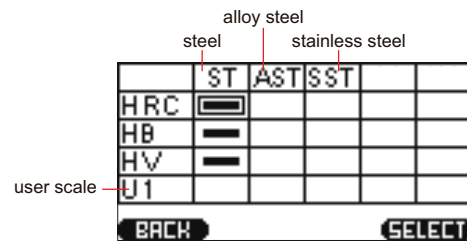

select the material and scale, use the corresponding standard hardness blocks or workpieces for calibration (calibration of HRC, HB and HV for steel are already made, calibration is needed before use other materials and scales)

OPTIONAL ACCESSORY

Probe B	ISHU-460-B
Couplant	ISH-COUPPLANT
Hardness block HRC20~30	ISH-BHRC1
Hardness block HRC45~50	ISH-BHRC2
Hardness block HRC60~65	ISH-BHRC3
Hardness block 150~250HV5	ISH-BHV5A
Hardness block 400~500HV5	ISH-BHV5B
Hardness block 650~750HV5	ISH-BHV5C
Hardness block 75~125HBW10/1000	ISH-BHB10A
Hardness block 175~250HBW10/3000	ISH-BHB10B
Hardness block 400~500HBW10/3000	ISH-BHB10C

PORTABLE LEEB HARDNESS TESTER APPLICABLE MATERIAL AND HARDNESS RANGE OF IMPACT DEVICE D

Material	HLD	HV	HB	HRC	HRB	HS	Tensile strength (MPa)
Steel & cast steel	300-900	81-955	81-654	20-68	38-100	32-100	375-2639
Tool steel	300-840	80-898		20-67			
Stainless steel	300-800	85-802	85-655		46-101		
Cast iron	360-650		93-334				
Cast aluminum alloy	170-570		19-164		23-84		
Brass	200-550		40-173		13-95		
Bronze	300-700		60-290				
Copper	200-690		45-315				

PORTABLE LEEB HARDNESS TESTER CODE ISH-PHB



- Based on Leeb (HLD), converted to Vickers (HV), Brinell (HB), Rockwell (HRC and HRB), Shore (HS) and tensile strength (MPa)
- Memory of 99 measurement values for browsing
- Set measurement times (1-9) to have average value
- Connected with printer via bluetooth
- Automatic power off, according to ASTM A 956



hardness test block D (included)



small support ring (included)



wireless printer (optional)

SPECIFICATION

Min. reading	1HLD, 1HV, 1HB, 0.1HRC, 0.1HRB, 1HS, 1MPa	
Accuracy	±6HLD (when HLD=800)	
Display	Leeb (HLD), converted hardness, material, impact direction, test times, average value, date	
Output	bluetooth	
Applicable workpiece	minimum weight	5kg 2kg (on solid support) 0.1kg (coupled on plate)
	minimum thickness	5mm
	minimum radius of curved surface	30mm
	maximum roughness (Ra)	1.6µm
Power supply	3×AAA batteries	
Dimension	150×84×28mm	
Weight	200g	

STANDARD DELIVERY

Main unit	1 pc
Impact device D	1 pc
Hardness test block D	1 pc
Small support ring	1 pc
Cleaning brush	1 pc

OPTIONAL ACCESSORY

Wireless printer	ISH-DS-PRINTER
Couplant	ISH-COUPPLANT
Support rings	see details
Hardness test block D	ISH-BHLD



PORTABLE LEEB HARDNESS TESTER CODE ISH-SPHA

- Based on Leeb (HL), converted to Vickers (HV), Brinell (HB), Rockwell (HRC and HRB), Shore (HS) and tensile strength (MPa)
- Connected with printer via bluetooth
- Connected with computer via USB port
- Up to 800 test results can be saved
- Tolerance testing
- Touch screen operation, large display with backlight
- Language: English, Chinese, Italian, German, French and Portuguese
- Automatic power off
- According to ASTM A 956



software CD
(included)



hardness test
block D (included)



small support ring
(included)



printer (included)

SPECIFICATION

Min. reading	1HL, 1HV, 1HB, 0.1HRC, 0.1HRB, 1HS, 1MPa
Accuracy	±6HL (when HL=800)
Display	Leeb (HL), converted hardness, material, impact direction, test times, average value, deviation, time
Output	bluetooth and USB
Power supply	built-in rechargeable battery
Dimension	135×83×24mm
Weight	350g

STANDARD DELIVERY

Main unit	1 pc
Impact device D	1 pc
Printer	1 pc
Hardness test block D	1 pc
Small support ring	1 pc
Cleaning brush	1 pc
AC/DC adapter	1 pc
USB cable and software disc	1 pc
Pen for touch screen	1 pc

OPTIONAL ACCESSORY

Impact device DC	ISH-SPHA-DC
Impact device C	ISH-SPHA-C
Impact device D+15	ISH-SPHA-D15
Impact device DL	ISH-SPHA-DL
Impact device G	ISH-SPHA-G
Hardness test block D*	ISH-BHLD
Hardness test block G*	ISH-BHLG
Couplant	ISH-COUPPLANT
Support rings	see details

- * Hardness test block G (ISH-BHLG) is for impact device G (ISH-SPHA-G).
Hardness test block D (ISH-BHLD) is for all others impact devices.

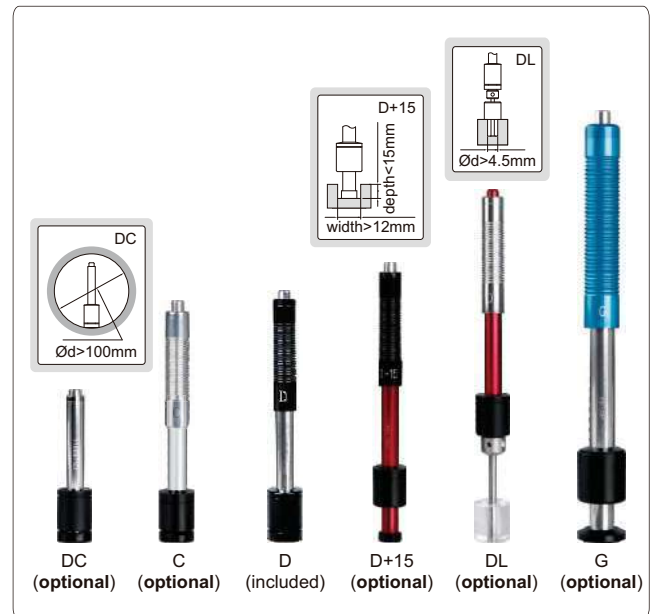

APPLICABLE WORKPIECE

Impact device	DC	C	D	D+15	DL	G
Application	inner wall of small space	small or thin workpiece, coating layer	general use	deep groove	narrow slot or small hole	casting or forging workpiece
Maximum roughness of workpiece (Ra)	1.6µm	0.4µm	1.6µm	1.6µm	1.6µm	7µm
Minimum weight of workpiece	direct measurement	5kg	1.5kg	5kg	5kg	15kg
	on solid support	2kg	0.5kg	2kg	2kg	5kg
	coupled on plate	0.1kg	0.02kg	0.1kg	0.1kg	0.5kg
Minimum thickness of workpiece	5mm	1mm	5mm	5mm	5mm	10mm

PORTABLE LEEB HARDNESS TESTER (BASIC TYPE) CODE HDT-LP200



- Can change probes
- Dual-coil probe for high accuracy
- Universal testing angle, no need to set impact direction
- Based on Leeb (HLD), converted to Vickers (HV), Brinell (HB), Rockwell (HRC, HRA and HRB), Shore (HS) and tensile strength (SGM)
- Dual value display, shows both Leeb and converted hardness
- Large LCD display with backlight
- Can choose large font display and statistics display
- Automatically calculate maximum, minimum and average value
- Save 300 data
- Operating temperature: -10°C~45°C
- According to ASTM A956, DIN 50156, GB/T 17394



wireless printer
(optional)



hardness test
block D (included)



small support ring
(included)

SPECIFICATION

Resolution	1HLD/1HV/1HB/0.1HRC/0.1HRB/ 0.1HRA/0.1HS/1SGM
Accuracy	±2HLD/±0.3% (when HLD=800)
Measuring range	HL 100-960/HRC 0.9-79.2/HRB 1-140/ HB 1-1878/HV 1-1698/HS 0.5-1370/ HRA 1-88.5/SGM (rm) 1-6599N/mm ²
Power supply	2xAA battery
Dimension	127×67×30mm
Weight	240g

STANDARD DELIVERY

Main unit	1pc
Hardness test block D	1pc
Small support ring	1pc
Cleaning brush	1pc
Impact device D	1pc

OPTIONAL ACCESSORY

Impact device DC	HDT-LP200-DC
Impact device C	HDT-LP200-C
Impact device D+15	HDT-LP200-D15
Impact device DL	HDT-LP200-DL
Impact device E	HDT-LP200-E
Impact device G	HDT-LP200-G
Hardness test block D *	ISH-BHLD
Hardness test block G *	ISH-BHLG
Printer	ISH-LP200-PRINTER
Support rings	see details

* Hardness test block G (ISH-BHLG) is for impact device G (ISH-LP200-G).
Hardness test block D (ISH-BHLD) is for all others impact devices.

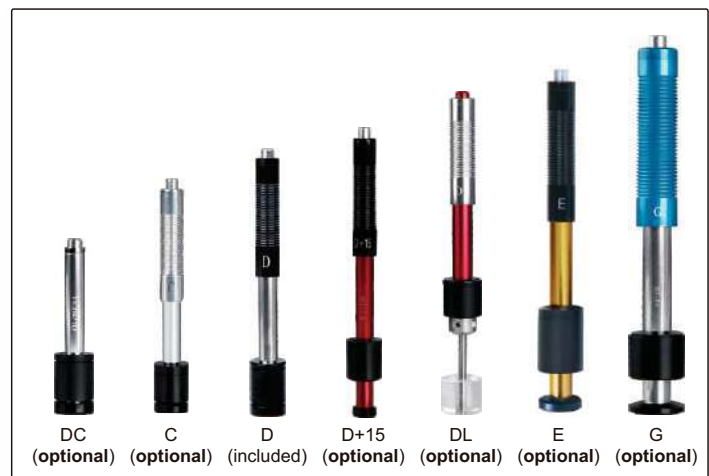
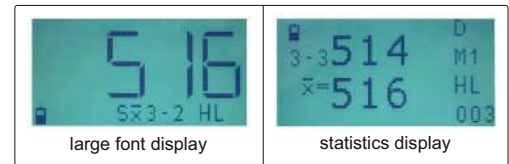

APPLICABLE WORKPIECE

Impact device	DC	C	D	D+15	DL	E	G
Application	inner wall of small space	small or thin workpiece, coating layer	general use	deep groove	narrow slot or small hole	very hard material	casting or forging workpiece
Maximum roughness of workpiece (Ra)	2µm	0.4µm	2µm	2µm	2µm	2µm	7µm
Minimum weight of workpiece	direct measurement	5kg	1.5kg	5kg	5kg	5kg	15kg
	on solid support	2kg	0.5kg	2kg	2kg	2kg	5kg
	coupled on plate	0.05kg	0.02kg	0.05kg	0.1kg	0.05kg	0.5kg
Minimum thickness of workpiece	3mm	1mm	3mm	3mm	3mm	3mm	10mm

DATA OUTPUT

HIGH ACCURACY

DL PROBE IS OPTIONAL

PORTABLE LEEB HARDNESS TESTER (HIGH ACCURACY) CODE HDT-L410

INSPECTION CERTIFICATE



software CD (included)



hardness test block D (included)



wireless printer (optional)



small support ring (included)

DL probe can be installed (optional)



- Metal housing
- HD TFT 320×320 display
- Impact device D
- Accuracy: $\pm 2\text{HLD} \pm 0.3\%$ (when $\text{HLD}=800$)
- Based on Leeb (HLD), converted to Vickers (HV), Brinell (HB), Rockwell (HRC, HRA and HRB), Shore (HS) and tensile strength (SGM)
- Four display modes
- Automatic direction correction
- Tolerance testing
- Automatic power off, automatic calculation of statistics
- Dual value display, shows both Leeb and other conversion values
- 31 files can be saved, each containing 100 measurement data
- Connected to PC software via USB or Bluetooth 2.0
- Connected with printer via Bluetooth
- Operating temperature: $-20^{\circ}\text{C} \sim 70^{\circ}\text{C}$
- According to ASTM A956, DIN 50156, GB/T 17394



dynamic ring display

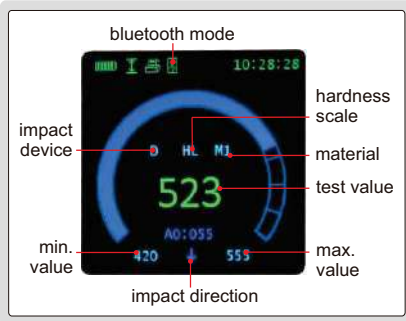

statistic display

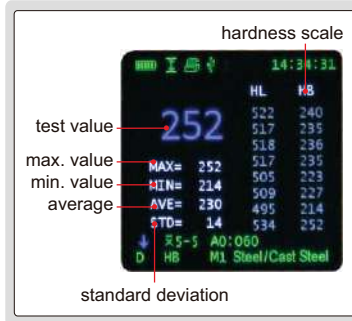

regular display

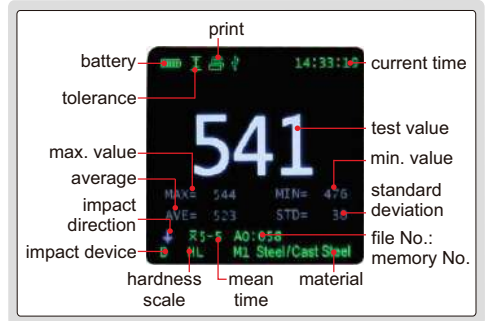

Software (included), upload the memory to PC, print and send to EXCEL

upload the memory to PC software via USB cable or Bluetooth



send the stored data to EXCEL

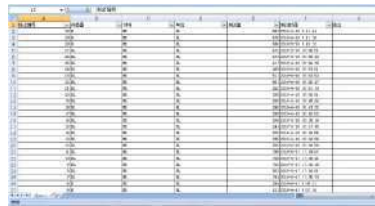

histogram display

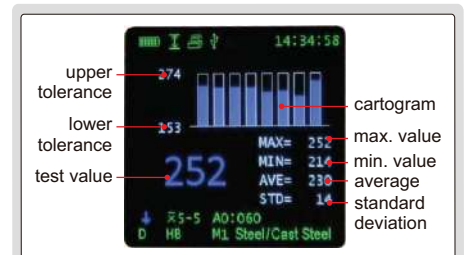

SPECIFICATION

Resolution	1HLD, 1HV, 1HB, 0.1HRC, 0.1HRB, 0.1HRA, 0.1HS, 1SGM	
Accuracy	$\pm 2\text{HLD} \pm 0.3\%$ (when $\text{HLD}=800$)	
Output	USB and bluetooth	
Applicable workpiece	minimum weight	5kg (direct measurement)
		2kg (on solid support)
	0.05kg (coupled on plate)	
Applicable workpiece	minimum thickness: 5mm	
	minimum radius of curved surface: 30mm	
	maximum roughness (Ra): 2 μm	
Power supply	built-in 3.7V rechargeable battery	
Dimension	148×44×22mm	
Weight	115g	

STANDARD DELIVERY

Main unit	1 pc
Hardness test block D	1 pc
Small support ring	1 pc
Cleaning brush	1 pc
AC/DC adapter	1 pc
USB cable and software disc	1 pc

OPTIONAL ACCESSORY

Printer	HDT-L410-PRINTER
Support rings	see details
Hardness test block D	ISH-BHLD
DL probe	HDT-L410-DL

PORTABLE LEEB HARDNESS TESTER (BASIC TYPE) CODE HDT-L411

DATA
OUTPUT

INSPECTION
CERTIFICATE



software CD
(included)



VIDEO



hardness test
block D (included)



small support ring
(included)



large font display

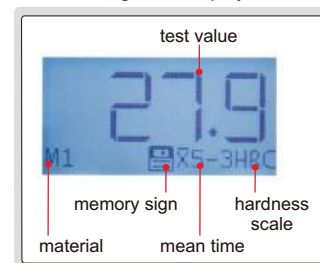

Software (included), upload the memory
to PC, print and send to EXCEL

upload the memory to PC
software via USB cable



send the stored data to EXCEL



- Impact device D
- Universal testing angle, no need to set impact direction
- Dual-coil probe, high accuracy
- Based on Leeb (HLD), converted to Vickers (HV), Brinell (HB), Rockwell (HRC, HRA and HRB), Shore (HS) and tensile strength (SGM)
- Dual value display, shows both Leeb and converted hardness
- High contrast digital LCD display
- Can choose large font display
- Automatically calculate maximum, minimum, average value
- Connected to PC via USB
- Save 999 data
- Operating temperature: -20°C~45°C
- According to ASTM A956, DIN 50156, GB/T 17394

SPECIFICATION

Resolution	1HLD, 1HV, 1HB, 0.1HRC, 0.1HRB, 0.1HRA, 0.1HS, 1SGM	
Accuracy	±2HLD/±0.3% (when HLD=800)	
Output	USB	
Measuring range	HL100-960, HRC1-74.7, HRB1.2-140, HB28-1027, HV45-1230 HS4-112, HRA7-88.5, SGM (rm) 118-3315N/mm ²	
Applicable workpiece	minimum weight	5kg (direct measurement)
		2kg (on solid support)
		0.05kg (coupled on plate)
	minimum thickness: 5mm	
minimum radius of curved surface: 30mm		
maximum roughness (Ra): 2µm		
Power supply	1xAAA battery	
Dimension	148×45×21mm	
Weight	105g	

STANDARD DELIVERY

Main unit	1 pc
Hardness test block D	1 pc
Cleaning brush	1 pc
AAA battery	1 pc
Small support ring	1 pc
USB cable and software disc	1 pc

OPTIONAL ACCESSORY

Support rings	see details
Hardness test block D	ISH-BHLD



SUPPORT RING SET FOR PORTABLE LEEB HARDNESS TESTER CODE ISH-PH-SP9

type A

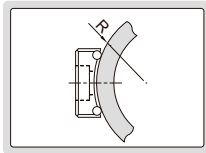

type B

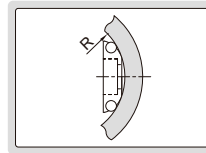

type C

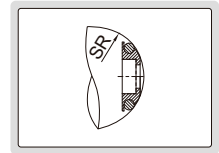

SPECIFICATION

Type	Applicable workpiece	Range (mm)	Quantity
A	cylindrical outside surface	R10-15	3 pcs
		R14.5-30	
		R25-50	
B	cylindrical inside surface	R11-13	3 pcs
		R12.5-17	
		R16.5-30	
C	spherical inside surface	SR11-13	3 pcs
		SR12.5-17	
		SR16.5-30	
D	spherical outside surface	SR10-15	2 pcs
		SR14.5-30	
E	cylindrical outside surface	R > 10	1 pcs

type D

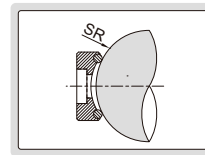

type E

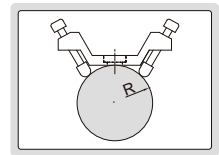

DIGITAL MAGNETIC ROCKWELL HARDNESS TESTER CODE ISHR-D121



flat anvil for test block
(included)



- Apply to large and heavy steel or iron workpieces
- With statistic function, display average, maximum and minimum values
- Convert to HV, HB and tensile strength
- According to ISO 6508, ASTM E18

SPECIFICATION

Hardness scale	HRA, HRB, HRC
Preliminary test force	10kg
Test force	60kg, 100kg, 150kg
Load control	manual
Min. reading	0.1HR
Flat workpiece requirement	length>190mm, width>60mm, thickness>5mm
Cylinder or tube workpiece requirement	length>200mm, diameter>Ø50mm, wall thickness>8mm
Power supply	3×AAA batteries
Dimension	245×105×230mm
Weight	5.3kg

STANDARD DELIVERY

Main unit	1 pc
Flat anvil	1 pc
Diamond indenter	1 pc
Ø1.5875mm carbide ball indenter	1 pc
Hardness test block HRB85~95	1 pc
Hardness test block HRC60~70	1 pc
Hardness test block HRC20~30	1 pc

MAGNETIC ROCKWELL HARDNESS TESTER CODE ISHR-M111

- Apply to large and heavy steel or iron workpieces
- According to ISO 6508, ASTM E18



flat anvil for test block (included)



supports for cylinder or tube workpieces (included)



magnifier with LED (included)

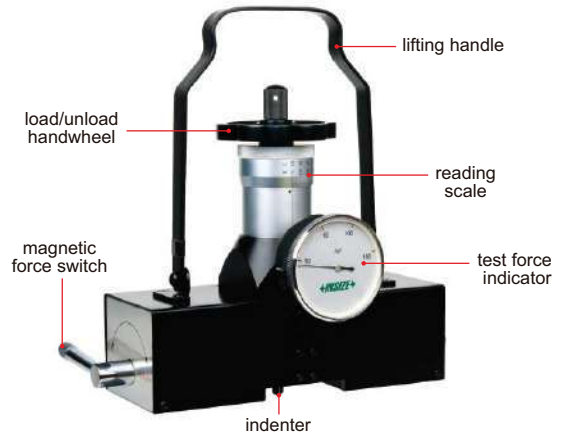

SPECIFICATION

Hardness scale	HRA, HRB, HRC, HRD, HRF, HRG
Preliminary test force	10kg
Test force	60kg, 100kg, 150kg
Load control	manual
Min. reading	1HR
Flat workpiece requirement	length>180mm, width>60mm, thickness>5mm
Cylinder or tube workpiece requirement	length>180mm, diameter>Ø50mm, wall thickness>8mm
Dimension	220×70×220mm
Weight	4.7kg

STANDARD DELIVERY

Main unit	1 pc
Diamond indenter	1 pc
Ø1.5875mm carbide ball indenter	2 pcs
Hardness test block HRB85~95	1 pc
Hardness test block HRC60~70	1 pc
Hardness test block HRC20~30	1 pc
Flat anvil	1 pc
Support	4 pcs
Magnifier with LED	1 pc

MAGNETIC BRINELL/ROCKWELL HARDNESS TESTER CODE ISHR-B141



flat anvil for test block (included)



supports for cylinder or tube workpieces (included)



magnifier with LED (included)



measuring microscope (included)

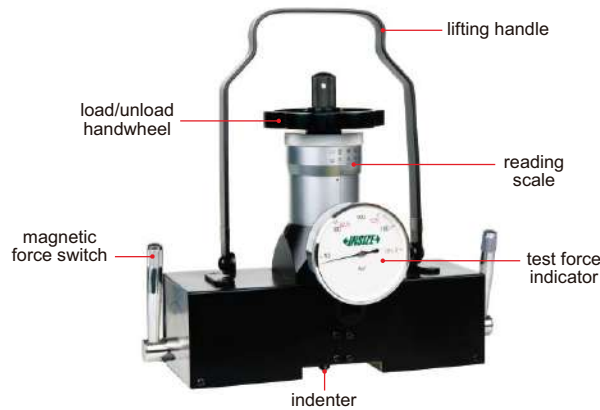

- Apply to large steel or iron workpieces
- According to ISO 6508, ASTM E18

SPECIFICATION

Rockwell scale	HRA, HRB, HRC, HRD, HRF, HRG
Brinell measuring range	20~650HBW
Rockwell test force	10kg preload, 60kg, 100kg, 150kg total load
Brinell test force	62.5kg, 125kg, 187.5kg
Load control	manual
Min. Rockwell reading	1HR
Measuring microscope	40X, graduation 0.01mm
Flat workpiece requirement	length>180mm, width>60mm, thickness>5mm
Cylinder and tube workpiece requirement	length>180mm, diameter>Ø50mm, thickness>8mm
Dimension	220×70×220mm
Weight	4.7kg

STANDARD DELIVERY

Main unit	1 pc
Flat anvil	1 pc
Support	4 pcs
Diamond Rockwell indenter	1 pc
Ø1.5875mm carbide ball indenter	1 pc
Ø2.5mm Brinell indenter	1 pc
Hardness test block HRB85~95	1 pc
Hardness test block HRC60~70	1 pc
Hardness test block HRC20~30	1 pc
Brinell test block	1 pc
Measuring microscope	1 pc
Magnifier with LED	1 pc

- According to ISO 6508, ASTM E18

SPECIFICATION

Hardness scale	HRA, HRB, HRC, HRD, HRF, HRG
Preliminary test force	10kg
Test force	60kg, 100kg, 150kg
Load control	manual
Min. reading	1HR
Max. workpiece thickness	25mm
Max. workpiece depth	25mm
Dimension	240×70×160mm
Weight (with base)	2.5kg

STANDARD DELIVERY

Main unit	1 pc
Diamond indenter	1 pc
Ø1.5875mm carbide ball indenter	2 pcs
Hardness test block HRB88~95	1 pc
Hardness test block HRC60~65	1 pc
Hardness test block HRC20~30	1 pc
Flat anvil	1 pc
V-type anvil	1 pc
Base	1 pc
Anvil extension	1 pc
Magnifier	2 pcs

PORTABLE ROCKWELL HARDNESS TESTER CODE ISHR-P151



- Measure Brinell hardness of large and heavy workpieces
- 1580kg test force and Ø7.26mm ball indenter, equal to 3000kg test force and Ø10mm ball indenter
- Static and impact test modes
- According to ISO and ASTM standard

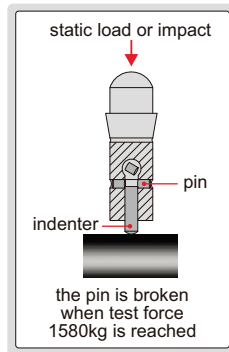

PIN BRINELL HARDNESS TESTER CODE ISHB-P101

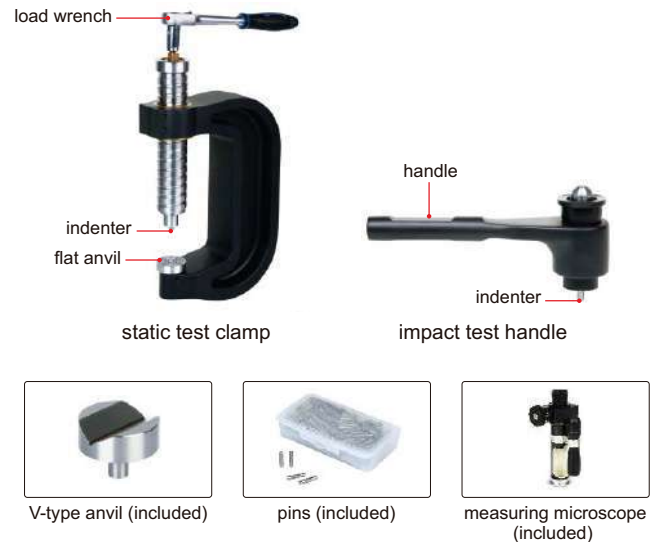

SPECIFICATION

Measuring range	100~350HBW (with Ø7.26mm indenter, included) 350~650HBW (with Ø4mm indenter, optional)
Test force	1580kg
Accuracy	static test: ±3% impact test: ±5%
Measuring microscope	20X, graduation 0.01mm
Max. workpiece height of static test	150mm
Max. workpiece depth of static test	80mm (from the center of indenter)
Dimension	195×60×350mm
Weight	4.2kg

STANDARD DELIVERY

Static test clamp	1 pc
Impact test handle	1 pc
Flat anvil	1 pc
V-type anvil	1 pc
Ø7.26mm indenter	1 pc
Hardness test block	1 pc
Pin	250 pcs
Measuring microscope	1 pc

OPTIONAL ACCESSORY

Ø4mm indenter	ISHB-P101-INDENTER
Pin (250 pcs)	ISHB-P101-PIN

HYDRAULIC BRINELL HARDNESS TESTER CODE ISHB-H131

- According to ISO 6506, ASTM E10



SPECIFICATION

Measuring range	16~650HBW
Test force	3000kg
Indenter	Ø10mm carbide ball
Measuring microscope	20X, graduation 0.01mm
Max. workpiece height	350mm
Max. workpiece depth	90mm (from the center of indenter)
Dimension	270×225×570mm
Weight	13.8kg

STANDARD DELIVERY

Main unit	1 pc
Flat anvil	1 pc
V-type anvil	1 pc
Spherical anvil	1 pc
Ø10mm carbide ball	2 pcs
Brinell test block	2 pcs
Measuring microscope	1 pc

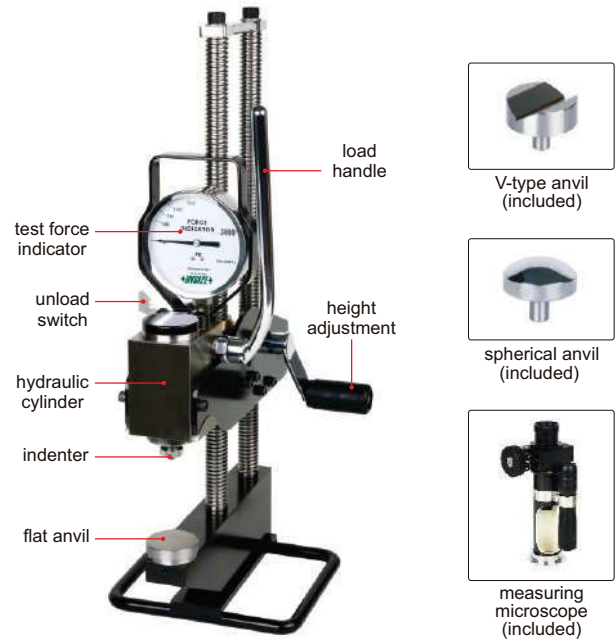

CHAIN TYPE HYDRAULIC BRINELL HARDNESS TESTER CODE ISHB-C161

- To measure the hardness of cylinders or tubes
- According to ISO 6506, ASTM E10

SPECIFICATION

Measuring range	32~650HBW
Workpiece diameter range	Ø150~Ø500mm
Test force	3000kg
Indenter	Ø10mm carbide ball
Measuring microscope	20X, graduation 0.01mm
Dimension	270×225×570mm
Weight	14.5kg

STANDARD DELIVERY

Main unit	1 pc
1.5m chain	1 pc
Ø10mm carbide ball	2 pcs
Brinell test block	2 pcs
Measuring microscope	1 pc



BARCOL HARDNESS TESTER CODE ISHB-B300



SPECIFICATION

Hardness range	0~100HBa (equal to 25~150HBW)
Min. reading	1HBa
Accuracy	±2HBa (at 42~52HBa) ±1HBa (at 84~88HBa)
Min. workpiece thickness	0.8mm
Dimension	142×65×90mm
Weight	500g



- To measure the hardness of workpieces made of pure aluminum, aluminum alloy, fiber reinforced plastic, hard plastic, etc.
- According to ASTM B648-00, ASTM D2853-07

STANDARD DELIVERY

Main unit	1 pc
Spare indenter	2 pcs
Hardness test block	2 pcs
Wrench	1 pc

WEBSTER HARDNESS TESTERS



ISHW-L20

- To measure the hardness of soft metal such as aluminum alloy, copper, brass, soft steel, etc.
- According to ASTM B647-84 (2000)

STANDARD DELIVERY

Main unit	1 pc
Spare indenter	1 pc
Hardness test block	1 pc
Wrench	1 pc

SPECIFICATION

Code	ISHW-L20	ISHW-L20A	ISHW-L20B	ISHW-B70	ISHW-B75	ISHW-B92
Application	for aluminum alloy general use	for aluminum alloy thick workpiece	for aluminum alloy small tube	for hard aluminum alloy and hard brass	for soft brass and copper	for soft steel and cold-rolled steel
Thickness requirement of flat workpiece	0.6~6mm	0.6~13mm	0.6~8mm	0.6~6mm	0.6~6mm	0.6~6mm
Internal diameter requirement of tube workpiece	>Ø10mm	>Ø10mm	>Ø6mm	>Ø10mm	>Ø10mm	>Ø10mm
Wall thickness requirement of tube workpiece	0.6~6mm	6~13mm (internal diameter Ø10~23.3mm) 0.6~6mm (internal diameter >Ø23.3mm)	0.6~8mm	0.6~6mm	0.6~6mm	0.6~6mm
Hardness range	0~20HW					
Min. reading	1HW					
Accuracy	±0.5HW (at 5~17HW)					
Dimension	205×30×85mm					
Weight	500g					

DATA OUTPUT

- According to ISO868, ISO7619, ASTM D 2240
- Average and peak (max.) mode
- Dwell time is adjustable
- Tolerance testing
- 500 memories
- Wireless connection to printer
- Handhold use or work with test stand (code ISH-DS-STANDA)
- Automatic power off



software CD (included)

SPECIFICATION

Code	ISH-DSA	ISH-DSD
Unit	Shore A	Shore D
Test material	soft plastic, soft rubber, etc.	hard plastic, hard rubber, etc.
Measuring range*	0~100HA	0~100HD
Resolution	0.1HA	0.1HD
Accuracy	±1HA	±1HD
Indenter protrusion	2.5mm	
Output	wireless and USB	
Power supply	built-in rechargeable battery	
Dimension	153×50×29mm	
Weight	170g	

* Use ISH-DSD when measuring result is higher than 90HA
Use ISH-DSA when measuring result is lower than 20HD

DIGITAL SHORE DUROMETERS



STANDARD DELIVERY

Main unit	1 pc
Calibration block	1 pc
USB cable and software	1 pc
AC/DC adapter	1 pc

OPTIONAL ACCESSORY

Printer	ISH-DS-PRINTER
Test stand	ISH-DS-STAND



calibration block (included)



printer (optional)

TEST STAND FOR DIGITAL SHORE DUROMETERS CODE ISH-DS-STANDA

- For digital shore durometers (code **ISH-DSA** and **ISH-DSD**)
- Perform repeatable hardness measurement due to fewer possibilities of human error or measurement variations
- Special structure for stable loading
- Weight block A is for **ISH-DSA** (included), weight block D is for **ISH-DSD** (optional)

SPECIFICATION

Stage diameter	Ø115mm
Maximum workpiece height	45mm
Dimension	Ø195×370mm
Weight	5.61kg

STANDARD DELIVERY

Test stand	1 pc
Weight block A (for ISH-DSA)	1 pc

OPTIONAL ACCESSORY

Weight block D (for ISH-DSD)	ISH-DS-W4
------------------------------	-----------



SHORE DUROMETERS

INSIZE PLUS
MADE IN GERMANY



- According to ISO868, ISO7619, ASTM D 2240
- With peak value indicator
- Handhold use or work with test stand (code **ISH-OS2**)

SPECIFICATION

Code	ISH-S30A	ISH-S30D
Scale	Shore A	Shore D
Test material	soft plastic, soft rubber, etc.	hard plastic, hard rubber, etc.
Measuring range *	0~100HA	0~100HD
Resolution	1HA	1HD
Accuracy	±0.5HA	±0.5HD
Indenter protrusion	2.5mm	
Weight	184g	

* Use **ISH-S30D** when measuring result is higher than 90HA
Use **ISH-S30A** when measuring result is lower than 20HD

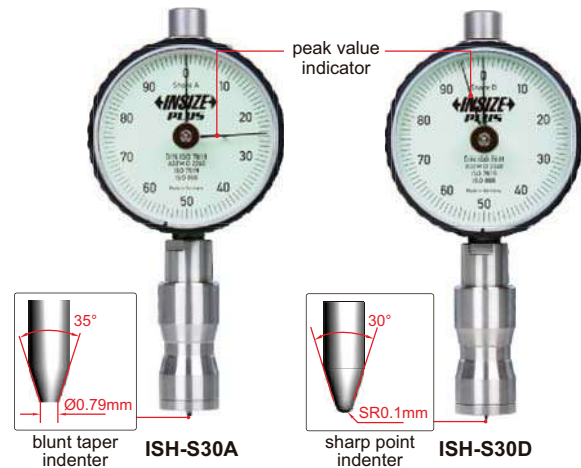

HARDNESS TEST BLOCKS FOR SHORE DUROMETERS

INSIZE PLUS
MADE IN GERMANY

SPECIFICATION

Code	ISH-S30A-BLOCK	ISH-S30D-BLOCK
Type	Shore A	Shore D
Hardness value	7 pcs/set: 30, 40, 50, 60, 70, 80, 90HA	3 pcs/set: 60, 75, 85HD



TEST STAND FOR SHORE DUROMETERS CODE ISH-OS2

INSIZE PLUS
MADE IN GERMANY

- For shore durometers (code **ISH-S30A** and **ISH-S30D**)
- Perform repeatable hardness measurement due to fewer possibilities of human error or measurement variations
- Special structure for stable loading
- 1kg weight block is for **ISH-S30A** (included), 4kg weight block is for **ISH-S30D** (optional)



SPECIFICATION

Stage diameter	Ø98mm
Maximum workpiece height	180mm
Maximum workpiece depth	115mm (from test point to column)
Dimension	Ø200×500mm
Weight	18kg

STANDARD DELIVERY

Test stand	1 pc
1kg weight block (for ISH-S30A)	1 pc
Calibration block	1 pc

OPTIONAL ACCESSORY

4kg weight block (for ISH-S30D)	ISH-OS2-W4
---------------------------------	------------

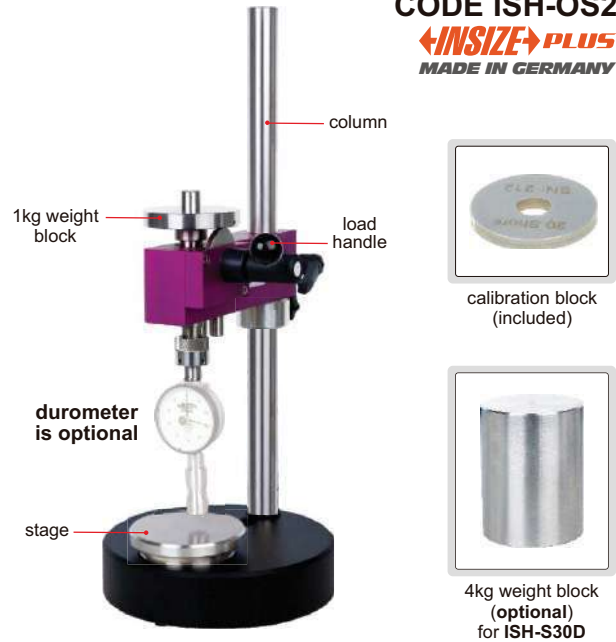

- According to ISO868, ISO7619, ASTM D 2240
- With peak value indicator
- Optional accessory: test stand **ISH-STAC** and **ISH-STD**



SPECIFICATION

Code	ISH-SAM	ISH-SDM
Scale	Shore A	Shore D
Application	nature rubber, soft elastomer, etc.	hard rubber, plastic, hard elastomer, etc.
Measuring range *	10~90HA	20~90HD
Graduation	1HA	1HD
Indenter protrusion	2.5mm	
Dimension	115×60×25mm	
Weight	160g	

* Use **ISH-SDM** when measuring result is higher than 90HA
Use **ISH-SAM** when measuring result is lower than 20HD

SHORE DUROMETERS

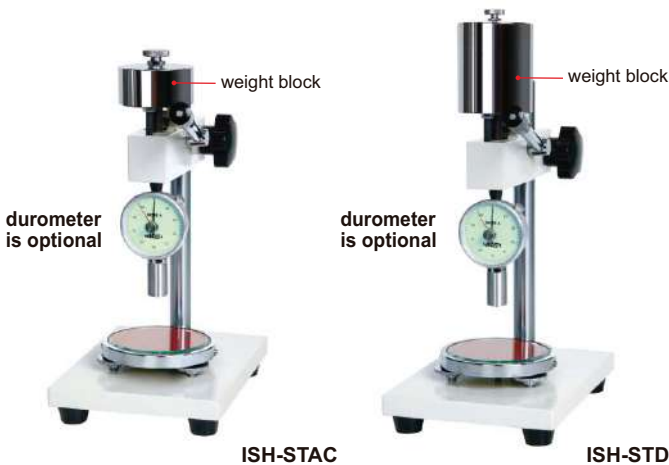
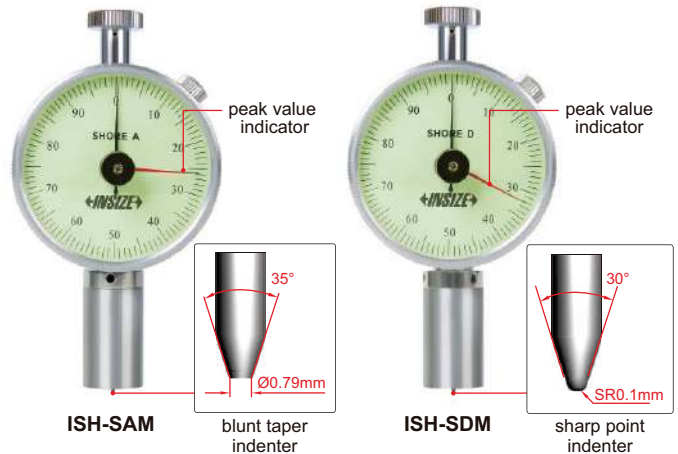

TEST STANDS FOR SHORE DUROMETERS

- For shore durometers (code **ISH-SAM** and **ISH-SDM**)
- Perform repeatable hardness measurement due to fewer possibilities of human error or measurement variations



SPECIFICATION

Code	ISH-STAC	ISH-STD
Applicable durometer	ISH-SAM	ISH-SDM
Stage diameter	Ø100mm	Ø100mm
Maximum workpiece height	75mm	75mm
Weight block	1kg	5kg

DIGITAL FORCE GAGES (HIGH ACCURACY)



**INSPECTION
CERTIFICATE**

DATA
OUTPUT

printer (optional)



software CD (included)



- Push and pull test
- Peak (max.) and tracking mode
- Units: mN, N, gf, kgf, ozf, lbf, MPa (only for type B)
- Tolerance testing
- 1000 memories
- Automatic power off
- Metal case, touch buttons
- LCD display with backlight
- The display flips over when the bottom faces up
- Overload alarm



ISF-DF100A
type A

ISF-DF5KA
type B

accessory for type A (included)

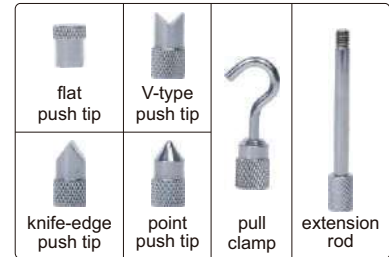

accessory for type B (included)



SPECIFICATION

Code	ISF-DF 5A	ISF-DF 10A	ISF-DF 20A	ISF-DF 50A	ISF-DF 100A	ISF-DF 200A	ISF-DF 500A	ISF-DF 1KA	ISF-DF 2KA	ISF-DF 5KA	ISF-DF 10KA	ISF-DF 20KA
Type	A (internal sensor)								B (external sensor)			
Load capacity (N)	5	10	20	50	100	200	500	1000	2000	5000	10000	20000
Resolution (N)	0.0005	0.001	0.005	0.005	0.01	0.05	0.05	0.1	0.5	0.5	1	5
Accuracy	±0.2% (of load capacity)											
Power supply	built-in rechargeable battery											

STANDARD DELIVERY

Code	ISF-DF 5A	ISF-DF 10A	ISF-DF 20A	ISF-DF 50A	ISF-DF 100A	ISF-DF 200A	ISF-DF 500A	ISF-DF 1KA	ISF-DF 2KA	ISF-DF 5KA	ISF-DF 10KA	ISF-DF 20KA
Main unit	1 pc								1 pc			
AC/DC adapter	1 pc								1 pc			
USB cable and software	1 pc								1 pc			
Push/pull accessory	6 pcs (flat push tip, V-type push tip, knife-edge push tip, point push tip, pull clamp, extension rod)								4 pcs (flat push tip, adapter, pull clamps)			

OPTIONAL ACCESSORY

Printer	ISF-DF-PRINTER
Test stand	ISF-MT1K

TEST STAND FOR DIGITAL FORCE GAGE CODE ISF-MT1K

- For digital force gages (code ISF-1DF□□□ and ISF-DF□□□)
- To be used in vertical and horizontal orientation

SPECIFICATION

Load capacity	1000N
Travel	200mm (3mm vertical movement per revolution of handwheel)
Dimension	196x250x446mm
Weight	13kg

OPTIONAL ACCESSORY

Digital scale (range: 200mm, resolution: 0.01mm/0.0005")	ISF-MT1K-SCALE
--	----------------

force gage is optional



digital scale (optional)



horizontal orientation test



- Push and pull test
- Units: N, gf, kgf, ozf, lbf
- 500 memories
- Automatic power off
- Metal case
- LCD display with backlight
- The display flips over when the bottom faces up
- Overload alarm

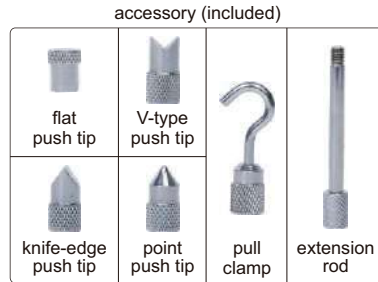

ISF-1DF100

DIGITAL FORCE GAGES

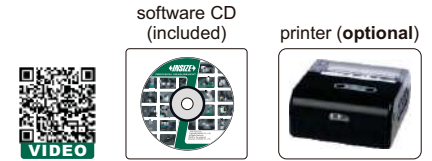

STANDARD DELIVERY

Main unit	1 pc
AC/DC adapter	1 pc
USB cable and software	1 pc
Push/pull accessory	6 pcs (flat push tip, V-type push tip, knife-edge push tip, point push tip, pull clamp, extension rod)

OPTIONAL ACCESSORY

Printer	ISF-DF-PRINTER
Test stand	ISF-MT1K

SPECIFICATION

Code	ISF-1DF10	ISF-1DF50	ISF-1DF100	ISF-1DF500	ISF-1DF1000
Load capacity (N)	10	50	100	500	1000
Resolution (N)	0.01	0.01	0.1	0.1	1
Accuracy	±0.3% (of load capacity)				
Measuring mode	tracking, peak (max.), tolerance testing				
Power supply	built-in rechargeable battery				
Dimension	150×73×33mm				
Weight	450g				

- Push and pull test
- Peak (max.) or tracking mode

STANDARD DELIVERY

Main unit	1 pc
Push tip	4 pcs (flat, V type, knife-edge, point)
Pull clamp	1 pc
Extension rod	1 pc

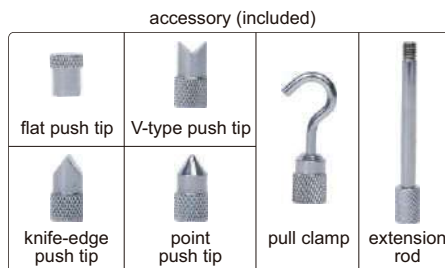

ISF-F500



SPECIFICATION

Code	ISF-F10	ISF-F20	ISF-F30	ISF-F50	ISF-F100	ISF-F200	ISF-F300	ISF-F500	
Capacity	N	10	20	30	50	100	200	300	500
	kgf	1	2	3	5	10	20	30	50
Graduation	N	0.05	0.1	0.2	0.25	0.5	1	2	2.5
Accuracy	±1% (of load capacity)								

OPTIONAL ACCESSORY

Test stand	ISF-MT500
------------	-----------

TEST STAND FOR FORCE GAGE CODE ISF-MT500

- For force gages (code ISF-F□□□)
- To be used in vertical and horizontal orientation



SPECIFICATION

Load capacity	500N
Travel	150mm (3mm vertical movement per revolution of handwheel)
Dimension	160×240×460mm
Weight	12kg

force gage is optional



horizontal orientation test

DIAL TENSION GAGES

- Clockwise and counter-clockwise use
- For electronic and precision mechanical industry, such as test the contact pressure of relay, adjust the tension or compression of spring

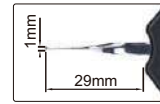

ISF-TG3

SPECIFICATION (Unit: N)

Code	ISF-TGD1	ISF-TGD3	ISF-TGD5	ISF-TG1	ISF-TG1D5	ISF-TG3	ISF-TG5
Range (N)	0.01~0.1	0.03~0.3	0.05~0.5	0.1~1	0.15~1.5	0.3~3	0.5~5
Graduation (N)	0.002	0.005	0.01	0.02	0.025	0.05	0.1
Accuracy	±2% (full scale)						
Dimension (L×W×H)	90×47×19mm						
Weight	60g						

SPECIFICATION (Unit: gf)

Code	ISF-TG10	ISF-TG30	ISF-TG50	ISF-TG100	ISF-TG150	ISF-TG300	ISF-TG500
Range (gf)	1~10	3~30	5~50	10~100	15~150	30~300	50~500
Graduation (gf)	0.2	0.5	1	2	2.5	5	10
Accuracy	±2% (full scale)						
Dimension (L×W×H)	90×47×19mm						
Weight	60g						

DIGITAL TORQUE TESTERS

ATTENTION: NOT SUITABLE FOR ELECTRIC WRENCHES, IMPACT WRENCHES OR PNEUMATIC WRENCHES

- With external sensor, to test torque wrenches, torque screwdrivers and other torque tools
- Clockwise and counter-clockwise operation
- Peak, track and first peak working modes
- Unit: N.m, in.lb, ft.lb, kg.cm
- Tolerance testing
- LED indicator for the target torque alarm:
 - Yellow LED light on when the value is below the low tolerance; green LED light on when the value is within tolerance; red LED light on when the value is above the high tolerance
 - The buzzer alarms when the maximum torque value is captured in the first peak mode
- Automatic power off



IST-TT550

STANDARD DELIVERY

Main unit	1 pc
Transducer with 1.5m cable	1 pc
Extension cable (1.2m)	1 pc
AC/DC adapter	1 pc
Adaptor	see details



extension cable (included)



adaptor (included)



with 3 mounting holes on the bottom

SPECIFICATION

Code	IST-TT05	IST-TT5	IST-TT50	IST-TT220	IST-TT550	IST-TT1000	IST-TT2200
Range	0.1~0.5N.m	0.5~5N.m	5~50N.m	22~220N.m	55~550N.m	100~1000N.m	220~2200N.m
Accuracy	±1% (clockwise and counter-clockwise)						
Resolution	0.0001N.m	0.0001N.m	0.001N.m	0.01N.m	0.01N.m	0.1N.m	0.1N.m
Square socket (L)	1/4"	1/4"	3/8"	1/2"	3/4"	1"	1"
Power supply	DC						
Adaptor	no	no	3/8" to 1/4"	1/2" to 3/8" 3/8" to 1/4"	3/4" to 1/2" 1/2" to 3/8"	1" to 3/4" 3/4" to 1/2" 1/2" to 3/8"	1" to 3/4" 3/4" to 1/2"
Transducer dimension	63×63×65mm	63×63×65mm	89×89×75mm	109×109×83mm	140×140×107mm	160×160×126mm	160×160×126mm
Weight	0.75kg	0.75kg	1.1kg	1.4kg	2.9kg	5.0kg	5.1kg

TORQUE WRENCH TEST STAND CODE IST-TS500



VIDEO



application example



digital torque tester (optional)



adaptor (optional, for digital torque tester IST-TT5, IST-TT50, IST-TT220)

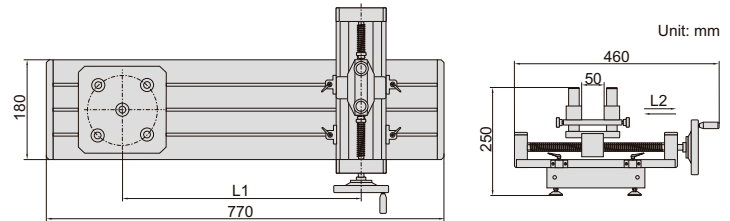

Unit: mm

- Work with digital torque testers (IST-TT5, IST-TT50, IST-TT220, IST-TT550)

SPECIFICATION

Digital torque tester	IST-TT5 (optional)	IST-TT50 (optional)	IST-TT220 (optional)	IST-TT550 (optional)
Applicable torque wrenches	0.5~5N.m	5~50N.m	22~220N.m	220~340N.m
Arm length (L1)	150~620mm, adjustable			
Maximum travel (L2)	200mm			
Weight	12.78kg			

OPTIONAL ACCESSORY

Digital torque tester	IST-TT5, IST-TT50, IST-TT220, IST-TT550
Adaptor	IST-TS500-BLOCK (necessary for IST-TT5, IST-TT50 and IST-TT220, not needed for IST-TT550)



printer (optional)



software CD (included)

- External sensor
- Metal case, touch buttons
- Clockwise and counter-clockwise operation
- Test mode: track, peak, first peak, preset tolerance
- Unit: N.m, N.cm, kgf.cm, lbf.in, lbf.ft
- Set tolerance with judgement
- 1000 memories
- LCD display with backlight, can automatically turn 180°
- Overload alarm
- Automatic power off



IST-DTT5

two display modes

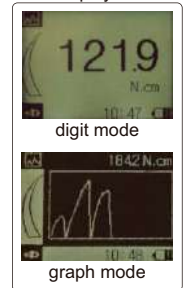

SPECIFICATION

Code	IST-DTT1	IST-DTT5	IST-DTT10
Load capacity	1N.m	5N.m	10N.m
Resolution	0.001N.m	0.001N.m	0.01N.m
Max. clamping diameter	Ø10mm	Ø10mm	Ø13mm
Sampling frequency	2000 times per second		
Accuracy	±0.3% (of load capacity)		
Output	USB, RS232, alarm signal		
Power supply	built-in rechargeable battery		
Dimension	145x73x34mm		
Weight	1.4kg		

DIGITAL TORQUE TESTERS



DATA OUTPUT

VIDEO

STANDARD DELIVERY

Main unit	1 pc
External sensor	1 pc
AC/DC adapter	1 pc
USB cable and software	1 pc

OPTIONAL ACCESSORY

Printer	ISF-DF-PRINTER
RS232 cable	IST-DTT-CABLE

DIGITAL BOTTLE CAP TORQUE TESTERS

- Measure the opening and tightening torque of bottle caps
- Unit: N.m, N.cm, kgf.cm, lbf.in, lbf.ft
- 1500 memories
- Wireless connection to printer
- Automatic power off
- LCD display with backlight
- Overload alarm
- With calibration function



software CD (included)



printer (optional)



IST-DCT20

DATA OUTPUT



VIDEO

SPECIFICATION

Code	IST-DCT2	IST-DCT5	IST-DCT10	IST-DCT20
Load capacity	2N.m	5N.m	10N.m	20N.m
Resolution	0.001N.m	0.001N.m	0.01N.m	0.01N.m
Clamping range	Ø19.5~190mm			
Accuracy	±0.5% (of load capacity)			
Measuring mode	tracking, peak (max.), first peak, double peak, tolerance testing			
Output	wireless and USB			
Power supply	built-in rechargeable battery			
Dimension	200×197×142mm			
Weight	2.5kg			

two display modes

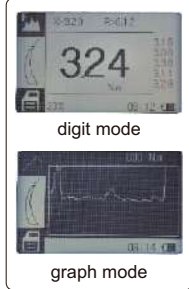

digit mode

graph mode

STANDARD DELIVERY

Main unit	1 pc
AC/DC adapter	1 pc
USB cable and software	1 pc

OPTIONAL ACCESSORY

Printer	ISH-DS-PRINTER
---------	----------------

DIGITAL TORQUE SCREWDRIVERS

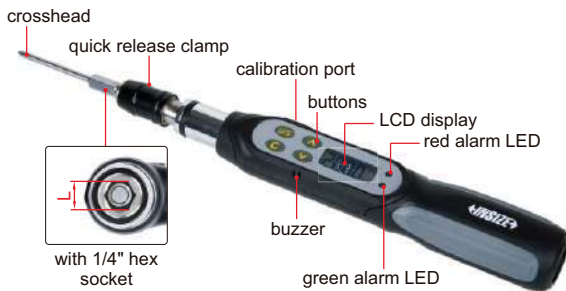

IST-SD200

OPTIONAL ACCESSORY

Calibration cable	IST-SD-CABLE
-------------------	--------------



VIDEO

- Clockwise and counter-clockwise operation
- Unit: cN.m, in.lb, kg.cm
- Peak and track working mode
- Target torque value can be set, with audible and visible alarm:
 - Green LED light on and buzzer sounds when target torque value is 90%~100% of target torque
 - Red LED light on and buzzer sounds when target torque value is reached
- Power off automatically in 5 minutes without any operations



SPECIFICATION

Code	IST-SD50	IST-SD200	IST-SD400
Range	10~50cN.m	40~200cN.m	80~400cN.m
Accuracy	clockwise	±3%	±2.5%
	counter-clockwise	±4%	±3.5%
Resolution	0.1cN.m	0.1cN.m	0.1cN.m
Size of hex socket (L)	1/4"	1/4"	1/4"
Power supply	1×AAA battery		
Length	193mm	203mm	203mm
Weight	190g	200g	200g

SMALL RANGE DIGITAL TORQUE WRENCHES

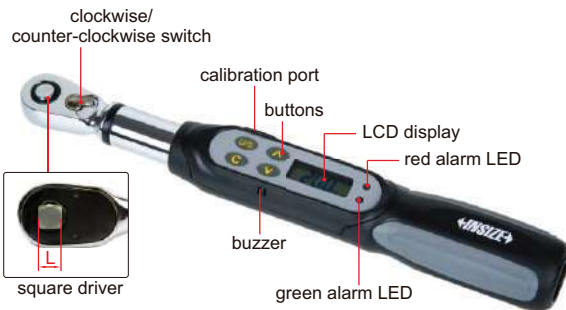

IST-WP20

OPTIONAL ACCESSORY

Calibration cable	IST-SD-CABLE
-------------------	--------------



VIDEO

- Clockwise and counter-clockwise operation
- Unit: N.m, in.lb, ft.lb, kg.cm
- Peak and track working mode
- Target torque value can be set, with audible and visible alarm:
 - Green LED light on and buzzer sounds when target torque value is 90%~100% of target torque
 - Red LED light on and buzzer sounds when target torque value is reached
- Power off automatically in 5 minutes without any operations
- Non-slip grip handle
- With overload record (once the torque reaches 110% of the maximum range)



SPECIFICATION

Code	IST-WP6	IST-WP12	IST-WP20
Range	1.2~6N.m	2.4~12N.m	4~20N.m
Accuracy	clockwise	±3%	±3%
	counter-clockwise	±4%	±4%
Resolution	0.001N.m	0.01N.m	0.01N.m
Square driver (L)	1/4"	1/4"	1/4"
Power supply	1×AAA battery		
Length	260mm	260mm	260mm
Weight	430g	430g	430g



SHORT HANDLE DIGITAL TORQUE WRENCHES

- Clockwise and counter-clockwise operation
- Unit: N.m, in.lb, ft.lb, kg.cm
- Peak and track working mode
- Target torque value can be set, with audible and visible alarm:
 - Green LED light on and buzzer sounds when torque value is 90%~100% of target torque
 - Both green and red LED light on and buzzer sounds when target torque value is reached
- Power off in 5 minutes automatically
- Non-slip grip handle
- With damp record
- With overload record (once the torque reaches 110% of the maximum range)



IST-WS60

SPECIFICATION

Code	IST-WS30	IST-WS30A	IST-WS60	IST-WS85
Range	6~30N.m	6~30N.m	12~60N.m	17~85N.m
Accuracy	clockwise	±3%		
	counter-clockwise	±4%		
Resolution	0.01N.m	0.01N.m	0.01N.m	0.1N.m
Square driver (L)	1/4"	3/8"	3/8"	3/8"
Power supply	2×AAA batteries			
Length	215mm	215mm	225mm	271mm
Weight	750g	830g	917g	1000g



OPTIONAL ACCESSORY

Calibration cable	IST-SD-CABLE
-------------------	--------------

OPTIONAL ACCURACY:
CLOCKWISE: ±1%
COUNTER-CLOCKWISE: ±2%
ONLY FOR RANGE 6~850N.m



DIGITAL TORQUE WRENCHES

- Clockwise and counter-clockwise operation
- Unit: N.m, in.lb, ft.lb, kg.cm
- Peak and track working mode
- Target torque value can be set, with audible and visible alarm:
 - Green LED light on and buzzer sounds when torque value is 90%~100% of target torque
 - Both green and red LED light on and buzzer sounds when target torque value is reached
- Power off automatically in 5 minutes without any operations
- Non-slip grip handle
- With damp record
- With overload record (once the torque reaches 110% of the maximum range)



IST-W135A



SPECIFICATION

Code	Range	Accuracy	Resolution	Square driver (L)	Power supply	Length	Weight
IST-W30A	6~30N.m	clockwise: ±2% counter-clockwise: ±3%	0.01N.m	1/4"	2×AA batteries	390mm	830g
IST-W135A	27~135N.m		0.1N.m	3/8"		415mm	950g
IST-W200A	40~200N.m		0.1N.m	1/2"		530mm	1.4kg
IST-W340A	68~340N.m		0.1N.m	1/2"		650mm	1.6kg
IST-W500A	100~500N.m	clockwise: ±2.5% counter-clockwise: ±3.5%	0.1N.m	3/4"		950mm	2.1kg
IST-W850A	170~850N.m		0.1N.m	3/4"		1220mm	2.55kg
IST-W1200A	240~1200N.m		1N.m	1"		1800mm	13kg
IST-W1500A	300~1500N.m		1N.m	1"		1800mm	13kg
IST-W2000A	400~2000N.m		1N.m	1"		1800mm	14kg
						1800mm	14kg

OPTIONAL ACCESSORY

Calibration cable	IST-W-CABLE
-------------------	-------------

BLUETOOTH DIGITAL TORQUE WRENCHES



OPTIONAL ACCURACY:
CLOCKWISE: ±1%
COUNTER-CLOCKWISE: ±2%

BUILT-IN
BLUETOOTH

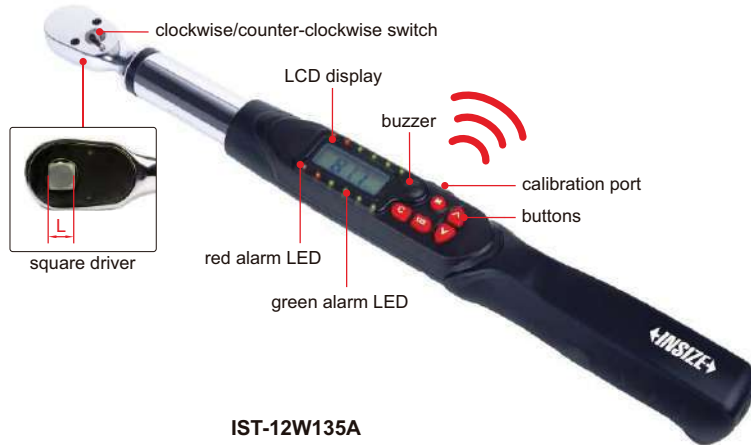

IST-12W135A

Torque wrench:

- Unit: N.m, in.lb, ft.lb, kg.cm
- Clockwise and counter-clockwise operation
- Peak and track working mode
- Can set tolerance with judgement in peak working mode
- 9 target torque values can be set, with audible and visible alarm:
 - Green LED light on and buzzer sounds when torque value is 80%~99.5% of target torque
 - Both green and red LED light on and buzzer sounds when torque value is over 99.5% of target torque
- Memory of 2000 results
- Power off in 2 minutes automatically
- Non-slip grip handle
- With overload record (once the torque reaches 110% of the maximum range)

Data transmission:

- Data transmission via bluetooth (bluetooth 4.0)
- Two-way transmission and control
- Transmission distance: 10m (no obstacles, no electromagnetic interference)
- Bluetooth connection and disconnection are displayed by indicator light

Software:

- Windows10 system version 1709 or above
- Two operation modes:
 - Data transmission mode: wrench transmits actual torque value to software after operation
 - Program guidance mode: firstly set process in software (set sequence of tightening, select wrench and set torque values and tolerances). Then software shows which wrench the operator should use (indicator light of the selected wrench is on) and shows the target torque value, and serial number of the screw to be tightened (shows on the wrench); After the operation is finished, the actual torque value is sent to software.
- Can select whether the wrench only sends qualified data after operation (in accordance with the tolerance)
- Two data transmission modes: automatic or press button to send
- When the wrench is disconnected, data is stored in the wrench and automatically sent to computer after connection via Bluetooth
- The data in software can be printed or exported to Excel



a computer can be connected with multiple wrenches, the transmission distance is 10 meters (no obstacles, no electromagnetic interference)

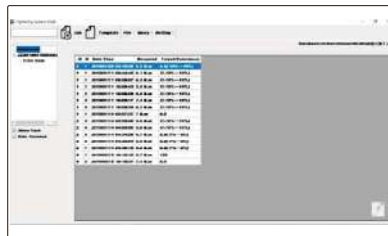

Data transmission mode

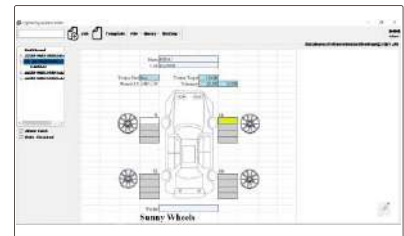

Program guidance mode

SPECIFICATION

Code	IST-12W30A	IST-12W135A	IST-12W200A	IST-12W340A
Range	6~30N.m	27~135N.m	40~200N.m	68~340N.m
Accuracy	clockwise	±2%		
	counter-clockwise	±3%		
Tolerance setting range	-20%~+20% (target torque value)			
Resolution	0.01N.m	0.1N.m	0.1N.m	0.1N.m
Square driver (L)	1/4"	3/8"	1/2"	1/2"
Power supply	2xAA batteries			
Length	390mm	415mm	530mm	650mm
Weight	760g	940g	1340g	1540g

OPTIONAL ACCESSORY

Calibration cable IST-W-CABLE

ATTENTION: CLOCKWISE
OPERATION ONLY

INTERCHANGEABLE HEAD TORQUE WRENCHES

**INSPECTION
CERTIFICATE**

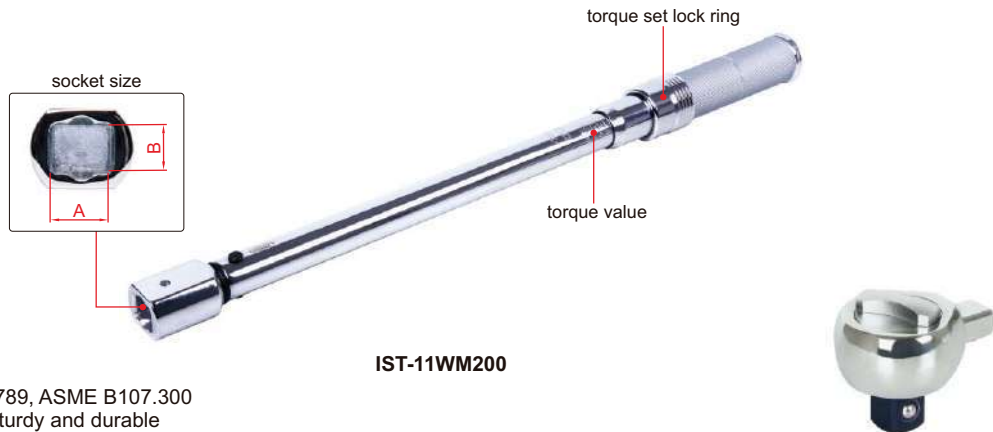

IST-11WM200

- According to DIN ISO 6789, ASME B107.300
- All-metal construction, sturdy and durable

SPECIFICATION

Code	Range (clockwise)	Accuracy	Graduation	Socket size (A×B)	Length	Weight
IST-11WM12	2.5~12N.m	±6% (<10N.m) ±4% (≥10N.m)	0.05N.m	12×9mm	284mm	580g
IST-11WM30	6.0~30N.m	±6% (<10N.m) ±4% (≥10N.m)	0.1N.m	12×9mm	303mm	720g
IST-11WM60	10~60N.m	±4%	0.5N.m	12×9mm	372mm	860g
IST-11WM125	25~125N.m	±4%	0.5N.m	12×9mm	427mm	940g
IST-11WM200	40~200N.m	±4%	1N.m	18×14mm	460mm	1060g
IST-11WM335	65~335N.m	±4%	1N.m	18×14mm	520mm	1200g

RATCHET HEAD (optional)

Code	Square driver	Applicable wrenches
IST-11WM-R1	1/4"	IST-11WM12 IST-11WM30
IST-11WM-R2	3/8"	IST-11WM12 IST-11WM30 IST-11WM60 IST-11WM125
IST-11WM-R3	1/2"	IST-11WM200 IST-11WM335
IST-11WM-R4*	3/4"	IST-11WM200 IST-11WM335



OPEN END HEAD (optional)

Code	Open size	Applicable wrenches
IST-11WM-K8	8mm	IST-11WM12 IST-11WM30 IST-11WM60 IST-11WM125
IST-11WM-K10	10mm	
IST-11WM-K13	13mm	
IST-11WM-K14	14mm	
IST-11WM-K15	15mm	
IST-11WM-K17	17mm	
IST-11WM-K19*	19mm	
IST-11WM-K13A	13mm	IST-11WM200 IST-11WM335
IST-11WM-K14A	14mm	
IST-11WM-K15A	15mm	
IST-11WM-K17A	17mm	
IST-11WM-K19A	19mm	
IST-11WM-K22A	22mm	
IST-11WM-K24A	24mm	
IST-11WM-K27A*	27mm	
IST-11WM-K30A*	30mm	
IST-11WM-K32A*	32mm	

BOX END HEAD (optional)

Code	Open size	Applicable wrenches
IST-11WM-M8	8mm	IST-11WM12 IST-11WM30 IST-11WM60 IST-11WM125
IST-11WM-M10	10mm	
IST-11WM-M13	13mm	
IST-11WM-M14	14mm	
IST-11WM-M15	15mm	
IST-11WM-M17	17mm	
IST-11WM-M19	19mm	
IST-11WM-M13A	13mm	IST-11WM200 IST-11WM335
IST-11WM-M14A	14mm	
IST-11WM-M15A	15mm	
IST-11WM-M17A	17mm	
IST-11WM-M19A	19mm	
IST-11WM-M22A	22mm	
IST-11WM-M24A	24mm	
IST-11WM-M27A	27mm	
IST-11WM-M30A	30mm	
IST-11WM-M32A	32mm	

*Torque value needs to be corrected with those heads

TORQUE WRENCHES

ATTENTION: CLOCKWISE OPERATION ONLY

- According to DIN ISO 6789, ASME B107.300
- All-metal construction, sturdy and durable



INSPECTION CERTIFICATE

IST-9WM335

SPECIFICATION

Code	IST-9WM12	IST-9WM20	IST-9WM30	IST-9WM60	IST-9WM100	IST-9WM125	IST-9WM200
Range (clockwise)	2.5~12N.m	4~20N.m	6~30N.m	10~60N.m	20~100N.m	25~125N.m	40~200N.m
Accuracy	±6% (<10N.m) ±4% (≥10N.m)	±6% (<10N.m) ±4% (≥10N.m)	±6% (<10N.m) ±4% (≥10N.m)	±4%	±4%	±4%	±4%
Graduation	0.1N.m	0.1N.m	0.2N.m	0.5N.m	0.5N.m	0.5N.m	1N.m
Square driver (D)	1/4"	1/4"	3/8"	3/8"	1/2"	1/2"	1/2"
Length	290mm	290mm	318mm	388mm	443mm	443mm	468mm
Weight	680g	680g	820g	960g	1040g	1040g	1160g

Code	IST-9WM335	IST-9WM500	IST-9WM800	IST-9WM1000	IST-9WM1500	IST-9WM2000	IST-9WM3000
Range (clockwise)	65~335N.m	100~500N.m	160~800N.m	200~1000N.m	300~1500N.m	400~2000N.m	600~3000N.m
Accuracy	±4%	±4%	±4%	±4%	±4%	±4%	±4%
Graduation	1N.m	2.5N.m	4N.m	5N.m	5N.m	10N.m	15N.m
Square driver (D)	1/2"	3/4"	3/4"	3/4"	1"	1"	1"
Length	528mm	855mm	1055mm	1055mm	1260mm	1260mm	1260mm
Weight	1300g	5000g	5900g	5900g	9200g	9200g	10500g

PRESET TORQUE WRENCHES

ATTENTION: CLOCKWISE OPERATION ONLY

- Torque is preset, to prevent adjustment by mistake during use
- The torque is set at the factory before delivery. Customers can also set the torque with torque adjustment tool (IST-PW-TOOL, optional) and digital torque testers (IST-TT□□□, optional)
- Clockwise operation only



IST-PW60



torque adjustment tool (optional)

SPECIFICATION

Code	IST-PW12	IST-PW20	IST-PW30	IST-PW60	IST-PW125	IST-PW200
Adjustable range *	2.5~12N.m	4~20N.m	6~30N.m	10~60N.m	25~125N.m	40~200N.m
Accuracy	±3%	±3%	±3%	±3%	±3%	±3%
Square driver (D)	1/4"	1/4"	3/8"	3/8"	3/8"	1/2"
Length	184mm	184mm	214mm	255mm	366mm	457mm
Weight	450g	450g	500g	560g	790g	1200g

Code	IST-PW340	IST-PW500	IST-PW650	IST-PW800	IST-PW1000A	IST-PW1000B
Adjustable range *	65~340N.m	100~500N.m	150~650N.m	160~800N.m	200~1000N.m	200~1000N.m
Accuracy	±3%	±3%	±4%	±4%	±4%	±4%
Square driver (D)	1/2"	3/4"	3/4"	3/4"	3/4"	1"
Length	691mm	910mm	910mm	1037mm	1265mm	1265mm
Weight	1960g	2800g	2800g	5000g	6000g	6000g

OPTIONAL ACCESSORY

Torque adjustment tool	IST-PW-TOOL
------------------------	-------------

* Adjust to a fixed torque value according to customer requirements before delivery

DIAL TORQUE WRENCHES



- Clockwise and counter-clockwise operation
- According to DIN ISO 6789, ASME B107.300

IST-DW70

SPECIFICATION

Code	IST-DW3D5	IST-DW9	IST-DW18	IST-DW35	IST-DW70	IST-DW140	IST-DW240	IST-DW350
Range	0.7~3.5N.m 6~30in.lb	1.8~9N.m 15~75in.lb	3.6~18N.m 30~150in.lb	7~35N.m 60~300in.lb	14~70N.m 120~600in.lb	28~140N.m 20~100ft.lb	48~240N.m 35~175ft.lb	70~350N.m 50~250ft.lb
Accuracy	$\pm 3\%$	$\pm 3\%$	$\pm 3\%$	$\pm 3\%$	$\pm 3\%$	$\pm 3\%$	$\pm 3\%$	$\pm 3\%$
Graduation	0.05N.m 0.5in.lb	0.1N.m 1in.lb	0.2N.m 2in.lb	0.5N.m 5in.lb	1N.m 10in.lb	2N.m 1ft.lb	3N.m 2.5ft.lb	2.5N.m 2.5ft.lb
Square driver (D)	1/4"	1/4"	3/8"	3/8"	3/8"	1/2"	1/2"	1/2"
Length	254mm	254mm	254mm	254mm	378mm	546mm	546mm	546mm
Weight	480g	480g	480g	480g	820g	1300g	1300g	1300g

DIGITAL TORQUE ADAPTERS

- Clockwise and counter-clockwise operation
- Set the desired torque first. After reaching the desired torque, set the angle and turn the wrench at this angle to apply extra torque
- Unit: N.m, in.lb, ft.lb, kg.cm, degree
- Peak and track working mode
- Target torque or angle value can be set, with audible and visible alarm:
 - Green LED light on and buzzer sounds when torque or angle value is 80%~100% of target torque or angle
 - Both green and red LED light on and buzzer sounds when target torque or angle value is reached
- Power off in 2 minutes automatically
- Memory 50 measurement values for browsing
- With overload record (once the torque reaches 110% of the maximum range)

IST-5W135A

SPECIFICATION

Code		IST-5W30A	IST-5W135A	IST-5W200A	IST-5W340A
Range	torque	6~30N.m	27~135N.m	40~200N.m	68~340N.m
	angle	0~999°			
Accuracy	clockwise	$\pm 3\%$			
	counter-clockwise	$\pm 4\%$			
	angle	$\pm 2^\circ$ (rotate at 90°)			
Resolution	torque	0.01N.m	0.1N.m	0.1N.m	0.1N.m
	angle	1°			
Square driver (L)		1/4"	3/8"	1/2"	1/2"
Power supply		2xAAA batteries			
Length		Ø85×60mm	Ø85×75mm	Ø85×80mm	Ø85×80mm
Weight		150g	220g	240g	240g



working with mechanical wrenches

OPTIONAL ACCESSORY

Calibration cable	IST-SD-CABLE
-------------------	--------------

TORQUE MULTIPLIERS



IST-TM2000



IST-TM3500P

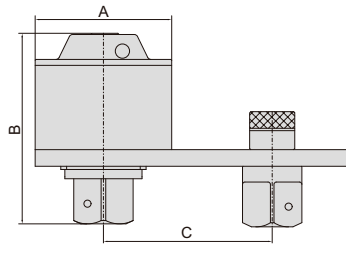
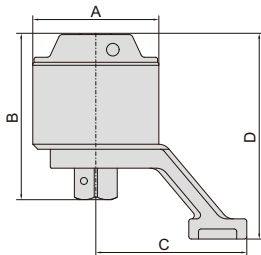

Example: the maximum output torque is 1000N.m (torque ratio is 1:4), the maximum input torque can not exceed 250N.m, otherwise may be damaged the torque multiplier

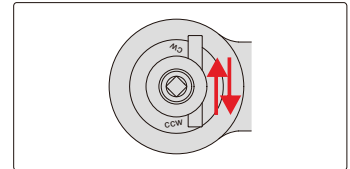

After reaching the target torque, toggle the anti-bounce reversing dowel, turn the wrench in the anticlockwise direction, then remove the wrench and torque multiplier

- Accuracy: $\pm 5\%$
- Suitable for occasions where space is limited and external power sources can not be used
- High-efficiency planetary gear sets input small torque, output high torque
- Torque multiplier output torque accuracy is $\pm 5\%$
- Alloy steel, long service life
- The position of the force cylinder (plate type) can be adjusted according to working conditions
- According to user's requirements, special reaction arm can be made

BEVEL TYPE TORQUE MULTIPLIER

Code	Capacity	Torque ratio	Square socket	Square driver	Dimension (A×B×C×D)	For bolt	For nut	Weight
IST-TM1000	1000N.m	1:4	1/2"	1"	82x98.5x97x122.4mm	M20~30	S30~46	2.1kg
IST-TM2000	2000N.m	1:13	1/2"	1"	82x120x105x147mm	M22~35	S32~55	3.15kg
IST-TM3500	3500N.m	1:16	1/2"	1"	98x131x120x163mm	M30~45	S46~70	4.9kg
IST-TM5500	5500N.m	1:20.5	1/2"	1 1/2"	115x163.5x137x199mm	M38~52	S55~80	8.1kg
IST-TM7500	7500N.m	1:23	1/2"	1 1/2"	127x173x146x215mm	M42~60	S65~90	10.6kg
IST-TM10000	10000N.m	1:28	1/2"	1 1/2"	141x170x164x238mm	M52~72	S80~105	14kg

PLATE TYPE TORQUE MULTIPLIER

Code	Capacity	Torque ratio	Square socket	Square driver	Dimension (A×B×C)	For bolt	For nut	Weight
IST-TM1000P	1000N.m	1:4	1/2"	1"	82x91x (76.7~127.3)mm	M20~30	S30~46	2.4kg
IST-TM2000P	2000N.m	1:13	1/2"	1"	82x120x (92.7~129.3)mm	M22~35	S32~55	3.5kg
IST-TM3500P	3500N.m	1:16	1/2"	1"	98x128x (102.7~145.3)mm	M30~45	S46~70	5.0kg
IST-TM5500P	5500N.m	1:20.5	1/2"	1 1/2"	115x157x (134.05~165.95)mm	M38~52	S55~80	8.7kg
IST-TM7500P	7500N.m	1:23	1/2"	1 1/2"	127x168x (139.05~190.95)mm	M42~60	S65~90	11.7kg
IST-TM10000P	10000N.m	1:28	1/2"	1 1/2"	141x186x (144.05~215.95)mm	M52~72	S80~105	15.2kg
IST-TM15000P	15000N.m	1:50	3/4"	2 1/2"	156x246x (155.25~244.75)mm	M60~85	S80~120	24.1kg
IST-TM20000P	20000N.m	1:76	3/4"	2 1/2"	170x264x (163.75~276.25)mm	M72~100	S105~145	27.8kg

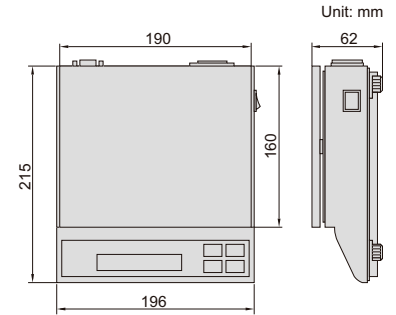
DATA OUTPUT
ELECTRONIC BALANCES

Unit: mm

- Automatic zero when power on
- Unit: g (gram), ct (carat), ozt (troy ounce)
- Weighing, counting, taring
- Overload alarm
- Data output

8301-3000

Code	8301-300	8301-600	8301-1200	8301-3000	8301-6000
Maximum weighing	300g	600g	1200g	3000g	6000g
Minimum weighing	0.2g	0.2g	0.2g	2g	2g
Resolution	0.01g	0.01g	0.01g	0.1g	0.1g
Weighing pan size	Ø135mm			190×160mm	
Verification scale interval	10d				
Working temperature	0~40°C				
Working humidity	≤80% RH				
Power supply	power adapter				
Dimension (L×W×H)	215×196×62mm				

 calibration weight
 (included in **8301-300**,
8301-600 and **8301-1200**)

 windshield
 (included in **8301-300**,
8301-600 and **8301-1200**)

OPTIONAL ACCESSORY

RS232 CABLE	8301-CABLE
--------------------	-------------------

WEIGHING SCALES (OIML CERTIFICATE)

- LCD display, with backlight
- Zero-setting, subtracting tare value
- Overload alarm
- Automatic power off
- OIML certificate (No. 0200-NAWI-04601)

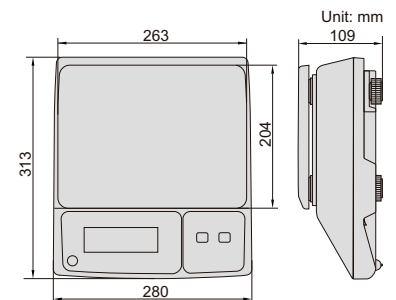

Unit: mm

8002-30M
SPECIFICATION

Code	8002-6M	8002-15M	8002-30M	8002-6MD	8002-15MD	8002-30MD
Maximum capacity	3/6kg	6/15kg	15/30kg	3/6kg	6/15kg	15/30kg
Minimum capacity	20g	40g	100g	20g	40g	100g
Division	1/2g	2/5g	5/10g	1/2g	2/5g	5/10g
Verification interval	2g	5g	10g	2g	5g	10g
Output	no			RS232		
Operating temperature	-10~40°C					
Power	rechargeable battery (6V/3.2Ah), power adapter (12V/500mA)					
Dimensions of pan	263×204mm					

WEIGHING SCALES (HIGH PRECISION)

- LCD display, with backlight
- Zero-setting, subtracting tare value
- Overload alarm
- Automatic power off



8001-30

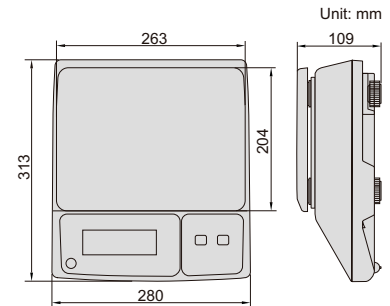

SPECIFICATION

Code	8001-6	8001-15	8001-30	8001-6D	8001-15D	8001-30D
Maximum capacity	6kg	15kg	30kg	6kg	15kg	30kg
Minimum capacity	4g	10g	20g	4g	10g	20g
Division	0.2g	0.5g	1g	0.2g	0.5g	1g
Verification interval	2g	5g	10g	2g	5g	10g
Output	no			RS232		
Operating temperature	-10~40°C					
Power	rechargeable battery (6V/3.2Ah), power adapter (12V/500mA)					
Dimensions of pan	263×204mm					



printer (optional)

OPTIONAL ACCESSORY (for scales with RS232)

Printer	8001-PRINTER
---------	--------------

COUNTING SCALES

- LCD display, with backlight
- Zero-setting, subtracting tare value, counting, accumulation, checking alarm
- Overload alarm



8101-30

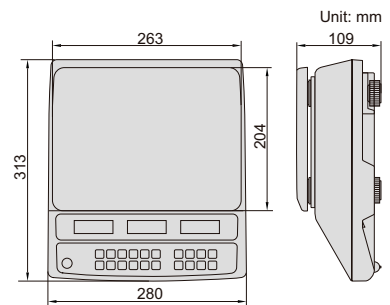

SPECIFICATION

Code	8101-6	8101-15	8101-30	8101-6D	8101-15D	8101-30D
Maximum capacity	6kg	15kg	30kg	6kg	15kg	30kg
Minimum capacity	4g	10g	20g	4g	10g	20g
Division	0.2g	0.5g	1g	0.2g	0.5g	1g
Verification interval	2g	5g	10g	2g	5g	10g
Output	no			RS232		
Operating temperature	-10~40°C					
Power	rechargeable battery (6V/3.2Ah), power adapter (12V/500mA)					
Dimensions of pan	263×204mm					



printer (optional)

OPTIONAL ACCESSORY (for scales with RS232)

Printer	8001-PRINTER
---------	--------------

IP65
WATERPROOF

ELECTRONIC CRANE SCALES

- Dust/waterproof level: IP65
- LED display, remote control
- Low voltage indicator
- Unit: kg, lb
- Automatic power off
- Overload alarm
- 360° safe rotary hook and shackle
- Aluminum alloy die casting case with high strength

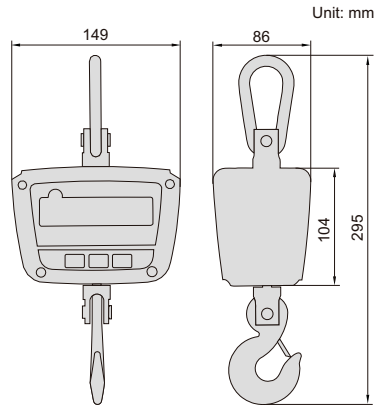

Remote controller (included)



8201-150KG

SPECIFICATION

Code	8201-50KG	8201-150KG	8201-300KG
Maximum capacity	50kg	150kg	300kg
Minimum capacity	0.4kg	1.0kg	2.0kg
Resolution	0.02kg/0.01kg	0.05kg/0.02kg	0.10kg/0.05kg
Operating temperature	-10~40°C		
Operating humidity	30%~90% RH		
Overload alarm	100%F.S.+9e		
Maximum safe load	125%F.S.		
Limited overload	400%F.S.		
Power supply	rechargeable battery 6V/3Ah (for 40 hours working)		
Stable reading time	≤8s		

STANDARD DELIVERY

Main unit	1 pc
Remote controller	1 pc
Battery charger	1 pc

ELECTRONIC CRANE SCALES (ECONOMIC TYPE)

- LED display, remote control
- Low voltage indicator
- Unit: kg, lb
- Automatic power off
- Overload alarm
- 360° safe rotary hook and shackle
- Plastic case

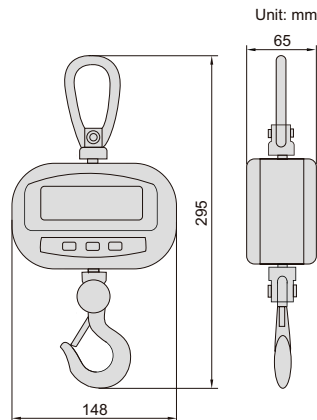

Remote controller (included)



8202-150KG

SPECIFICATION

Code	8202-50KG	8202-150KG	8202-300KG
Maximum capacity	50kg	150kg	300kg
Minimum capacity	0.4kg	1.0kg	2.0kg
Resolution	0.02kg/0.01kg	0.05kg/0.02kg	0.10kg/0.05kg
Operating temperature	-10~40°C		
Operating humidity	30%~90% RH		
Overload alarm	100%F.S.+9e		
Maximum safe load	125%F.S.		
Limited overload	400%F.S.		
Power supply	4×1.5V AA batteries (for 40 hours working)		
Stable reading time	≤8s		

STANDARD DELIVERY

Main unit	1 pc
Remote controller	1 pc

PLATFORM SCALES

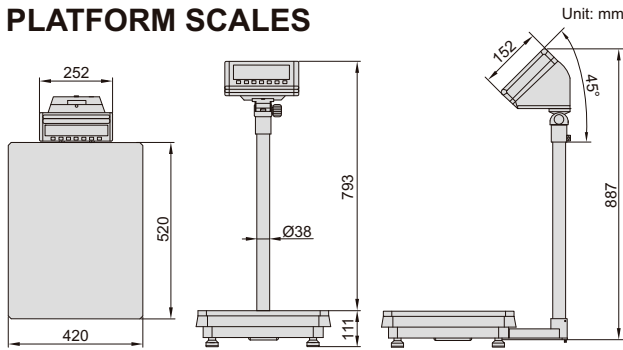

SPECIFICATION

Code	8501-AL60	8501-AL150	8501-AL300
Maximum capacity	60kg	150kg	300kg
Minimum capacity	100g	200g	400g
Division	5g	10g	20g
Verification interval	5g	10g	20g
Operating temperature	-10~40°C		
Material	platform: stainless steel, base: die-cast aluminum		
Dimension of platform	420×520mm		
Power	rechargeable lead acid battery (6V/4Ah)		
Output	RS232		
Weight	18.3kg		



8501-AL150

DATA OUTPUT



printer (optional)

- LCD large screen display with LED backlight
- Weighing, overweight alarm, counting, keyboard lock, accumulating, auto zero and animal scale
- Units: kg, g, lb, oz

OPTIONAL ACCESSORY

Printer	8001-PRINTER
---------	--------------

FLOOR SCALES

- LCD large screen display with automatic backlight
- Zeroing, overweight alarm, deduction, unit conversion, accumulating, animal scale, etc.
- Units: kg, g, lb, oz
- OIML approved load cell

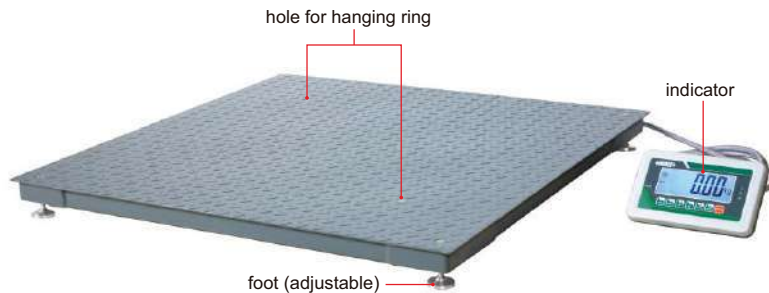

8401-1T1212

DATA OUTPUT



printer (optional)

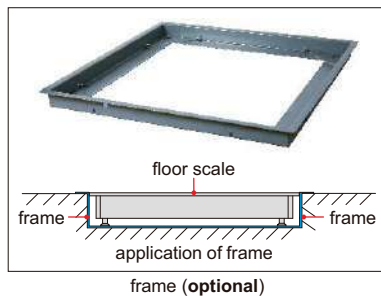

frame (optional)

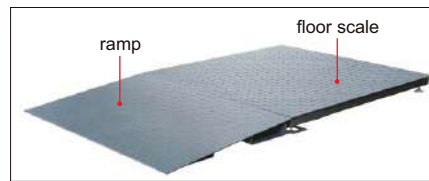

ramp (optional)

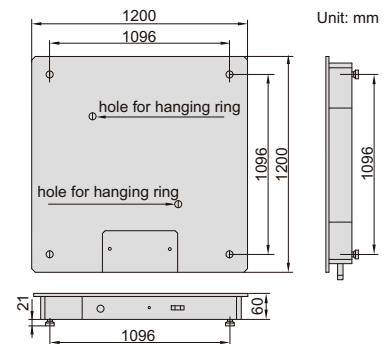

SPECIFICATION

Code	8401-1T1212	8401-2T1212	8401-3T1212
Maximum capacity	1t	2t	3t
Minimum capacity	10kg	20kg	20kg
Division	0.5kg	1kg	1kg
Verification interval	0.5kg	1kg	1kg
Load cell	4 pcs 350Ω		
Operating temperature	-10~40°C		
Material	mild steel		
Dimension of platform	1200×1200mm		
Power	rechargeable lead acid battery (6V/4Ah)		
Output	RS232		
Weight	140kg		

STANDARD DELIVERY

Main unit	1 pc
Indicator	1 pc
AC/DC adapter	1 pc
Stainless steel foot	4 pcs
Hanging ring	2 pcs

OPTIONAL ACCESSORY

Ramp	8401-1212-1
Frame	8401-1212-2
Stand	8401-STAND
Printer	8001-PRINTER



stand (optional)



OIML R111-2004 TOLERANCE

Weight	E2	F1	F2	M1
1mg	0.006mg	0.020mg	0.06mg	0.20mg
2mg	0.006mg	0.020mg	0.06mg	0.20mg
5mg	0.006mg	0.020mg	0.06mg	0.20mg
10mg	0.008mg	0.025mg	0.08mg	0.25mg
20mg	0.010mg	0.03mg	0.10mg	0.3mg
50mg	0.012mg	0.04mg	0.12mg	0.4mg
100mg	0.016mg	0.05mg	0.16mg	0.5mg
200mg	0.020mg	0.06mg	0.20mg	0.6mg
500mg	0.025mg	0.08mg	0.25mg	0.8mg
1g	0.03mg	0.10mg	0.3mg	1.0mg
2g	0.04mg	0.12mg	0.4mg	1.2mg
5g	0.05mg	0.16mg	0.5mg	1.6mg
10g	0.06mg	0.20mg	0.6mg	2.0mg
20g	0.08mg	0.25mg	0.8mg	2.5mg
50g	0.10mg	0.3mg	1.0mg	3.0mg
100g	0.16mg	0.5mg	1.6mg	5.0mg
200g	0.3mg	1.0mg	3.0mg	10mg
500g	0.8mg	2.5mg	8.0mg	25mg
1kg	1.6mg	5.0mg	16mg	50mg
2kg	3.0mg	10mg	30mg	100mg
5kg	8.0mg	25mg	80mg	250mg
10kg	16mg	50mg	160mg	500mg
20kg	30mg	100mg	300mg	1000mg

- Supplied with manufacturer inspection certificate

WEIGHT CLASS SELECTION

Accuracy of the weighing instrument	Resolution of the weighing instrument	Required class of weights
III medium accuracy	≤10000d	M1
II high accuracy	≤30000d	F2
	≤100000d	F1
I special accuracy	>100000d	E2

Weight	Class and material						Shape
	E2 (non-magnetic stainless steel)	F1 (non-magnetic stainless steel)	F1 (304 stainless steel)	F2 (304 stainless steel)	M1 (304 stainless steel)	M1 (steel chrome plated)	
1mg	8911-1MGE2	8911-1MGF1	8911-1MGF1S	8911-1MGF2	8911-1MGM1	8911-1MGM1C	sheet
2mg	8911-2MGE2	8911-2MGF1	8911-2MGF1S	8911-2MGF2	8911-2MGM1	8911-2MGM1C	
5mg	8911-5MGE2	8911-5MGF1	8911-5MGF1S	8911-5MGF2	8911-5MGM1	8911-5MGM1C	
10mg	8911-10MGE2	8911-10MGF1	8911-10MGF1S	8911-10MGF2	8911-10MGM1	8911-10MGM1C	
20mg	8911-20MGE2	8911-20MGF1	8911-20MGF1S	8911-20MGF2	8911-20MGM1	8911-20MGM1C	
50mg	8911-50MGE2	8911-50MGF1	8911-50MGF1S	8911-50MGF2	8911-50MGM1	8911-50MGM1C	
100mg	8911-100MGE2	8911-100MGF1	8911-100MGF1S	8911-100MGF2	8911-100MGM1	8911-100MGM1C	
200mg	8911-200MGE2	8911-200MGF1	8911-200MGF1S	8911-200MGF2	8911-200MGM1	8911-200MGM1C	
500mg	8911-500MGE2	8911-500MGF1	8911-500MGF1S	8911-500MGF2	8911-500MGM1	8911-500MGM1C	
1g	8911-1GE2	8911-1GF1	8911-1GF1S	8911-1GF2	8911-1GM1	8911-1GM1C	cylinder
2g	8911-2GE2	8911-2GF1	8911-2GF1S	8911-2GF2	8911-2GM1	8911-2GM1C	
5g	8911-5GE2	8911-5GF1	8911-5GF1S	8911-5GF2	8911-5GM1	8911-5GM1C	
10g	8911-10GE2	8911-10GF1	8911-10GF1S	8911-10GF2	8911-10GM1	8911-10GM1C	
20g	8911-20GE2	8911-20GF1	8911-20GF1S	8911-20GF2	8911-20GM1	8911-20GM1C	
50g	8911-50GE2	8911-50GF1	8911-50GF1S	8911-50GF2	8911-50GM1	8911-50GM1C	
100g	8911-100GE2	8911-100GF1	8911-100GF1S	8911-100GF2	8911-100GM1	8911-100GM1C	
200g	8911-200GE2	8911-200GF1	8911-200GF1S	8911-200GF2	8911-200GM1	8911-200GM1C	
500g	8911-500GE2	8911-500GF1	8911-500GF1S	8911-500GF2	8911-500GM1	8911-500GM1C	
1kg	8911-1KGE2	8911-1KGF1	8911-1KGF1S	8911-1KGF2	8911-1KGM1	8911-1KGM1C	
2kg	8911-2KGE2	8911-2KGF1	8911-2KGF1S	8911-2KGF2	8911-2KGM1	8911-2KGM1C	
5kg	8911-5KGE2	8911-5KGF1	8911-5KGF1S	8911-5KGF2	8911-5KGM1	8911-5KGM1C	
10kg	8911-10KGE2	8911-10KGF1	8911-10KGF1S	8911-10KGF2	8911-10KGM1	8911-10KGM1C	
20kg	8911-20KGE2	8911-20KGF1	8911-20KGF1S	8911-20KGF2	8911-20KGM1	8911-20KGM1C	

WEIGHT SETS



■ Supplied with manufacturer inspection certificate

CLASS AND MATERIAL

Specification	Code				
	E2 (non-magnetic stainless steel)	F1 (non-magnetic stainless steel)	F1 (304 stainless steel)	F2 (304 stainless steel)	M1 (304 stainless steel)
1mg~100g	8910-100GE2	8910-100GF1	8910-100GF1S	8910-100GF2	8910-100GM1
1mg~200g	8910-200GE2	8910-200GF1	8910-200GF1S	8910-200GF2	8910-200GM1
1mg~1kg	8910-1KGE2	8910-1KGF1	8910-1KGF1S	8910-1KGF2	8910-1KGM1
1mg~2kg	8910-2KGE2	8910-2KGF1	8910-2KGF1S	8910-2KGF2	8910-2KGM1
1mg~5kg	8910-5KGE2	8910-5KGF1	8910-5KGF1S	8910-5KGF2	8910-5KGM1

SPECIFICATION AND SHAPE

Weight	Specification				
	1mg~100g	1mg~200g	1mg~1kg	1mg~2kg	1mg~5kg
1mg	◆	◆	◆	◆	◆
2mg	◆◆*	◆◆*	◆◆*	◆◆*	◆◆◆*
5mg	◆	◆	◆	◆	◆
10mg	◆	◆	◆	◆	◆
20mg	◆◆*	◆◆*	◆◆*	◆◆*	◆◆◆*
50mg	◆	◆	◆	◆	◆
100mg	◆	◆	◆	◆	◆
200mg	◆◆*	◆◆◆*	◆◆◆*	◆◆◆*	◆◆◆◆*
500mg	◆	◆	◆	◆	◆
1g	■	■	■	■	■
2g	■◆*	■◆*	■◆*	■◆*	■◆◆*
5g	■	■	■	■	■
10g	■	■	■	■	■
20g	■◆*	■◆*	■◆*	■◆*	■◆◆*
50g	■	■	■	■	■
100g	■	■	■	■	■
200g		■◆*	■◆*	■◆*	■◆◆*
500g			■	■	■
1kg			■	■	■
2kg				■◆*	■◆◆*
5kg					■
Quantity	21 pcs	23 pcs	25 pcs	27 pcs	28 pcs
Total range	1mg~211.11g	1mg~611.11g	1mg~2111.11g	1mg~6111.11g	1mg~11111.11g

◆ sheet ■ cylinder
 ◆* sheet, with mark ■* cylinder, with mark



CUTTING MACHINE CODE MLP-CM60



cutting blade (optional)



coolant (optional)

- For metal and non-metal materials
- Cooling device avoids overheating and destroying sample structure
- With safety switch, the machine will automatically stop running when the cover is opened



SPECIFICATION

Maximum cutting diameter	Ø60mm
Cutting blade	Ø250×1.5×Ø25.4mm
Rotation speed	2800r/min
Motor power	2.2kW
Power supply	AC 380V
Dimension	760×620×450mm
Weight	82kg

water tank



STANDARD DELIVERY

Main unit	1 pc
Cutting blade	2 pcs
Coolant	1 barrel (4L)
Water tank	1 pc

OPTIONAL ACCESSORY

Description	Code	Specification
Coolant	MLP-CM60-COLT	4L, 1:20 diluted with water
Cutting blade	MLP-CM60-CUT	250×2×32mm, 50 pcs/box

- Automatic heating, pressuring, cooling and pressure relief
- Water cooling system

SPECIFICATION

Diameter of workpiece	Ø30mm
Heating temperature range	100~200°C
Delay range	0~999s
Hold time	0~999s
Cooling temperature	20~90°C
Heating power	600W
Power supply	AC 220V, 50Hz
Dimension	350×450×470mm
Weight	45kg

STANDARD DELIVERY

Main unit	1 pc
Hot mounting resin	1 bottle (250g)
Funnel	1 pc



hot mounting resin (optional)

OPTIONAL ACCESSORY

Description	Code	Specification
Hot mounting resin	MLP-MP30-PDR	black, 4kg

GRINDER AND POLISHER CODE MLP-GP260



- ABS case and stainless steel parts, anti-corrosion, easy to clean
- Can hold up to 4 samples
- Smooth rotation, low noise
- Adjustable speed
- Water cooling device and abrasive cleaning nozzle prevent samples from overheating and destroying structure
- Platen rotation direction can be selected
- Replaceable platen



SPECIFICATION

Platen diameter	Ø250mm
Platen rotation speed	50~1000r/min (stepless adjustable), 150/300r/min (two fixed speeds)
Platen rotation direction	clockwise or counterclockwise
Grinding head speed	50~150r/min (stepless adjustable)
Pressure range	5~60N
Operating time	5~995s
Sample diameter	Ø30mm
Air pressure	0.6~0.8MPa
Power supply	AC 220V, 50Hz
Input power	1.1kW
Dimension	730×795×594mm
Weight	90kg



silicon carbide paper
(optional)

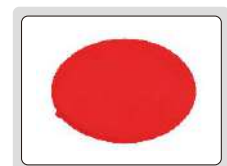

polishing cloth (optional)

STANDARD DELIVERY

Main unit	1 pc
Silicon carbide paper	6 pcs (200, 600, 1000)
Polishing cloth	4 pcs

OPTIONAL ACCESSORY

Description	Code	Specification
Silicon carbide paper	MLP-GP260-S□□*	50 pcs select granularity: 120, 180, 240, 400, 600, 800, 1000, 1200, 1500, 2000
Polishing cloth	MLP-GP260-CLT	15 pcs, long velvet silk material
Diamond polishing agent	MLP-GP260-D□□*	500ml select granularity (µm): W40, W28, W20, W14, W9, W7, W5, W 3.5, W2.5, W1.5, W1.0, W0.5, W0.25

* □□ is granularity specification, for example, code MLP-GP260-D40 stands for diamond polishing agent 40µm granularity



CODE	PAGE
11	
1106.....	17
1108.....	8
1109.....	9
1110.....	11
1111.....	12
1113.....	7
1114.....	8
1117.....	17
1118.....	7
1119.....	9
1120.....	24
1121.....	25
1122.....	29
1123.....	28
1124.....	23
1125.....	21
1126.....	8
1130.....	10
1135.....	18
1136.....	17
1139.....	12
1140.....	40
1141.....	35
1142.....	35
1143.....	36
1144.....	36
1145.....	40
1146.....	48
1147.....	36
1148.....	37
1149.....	34
1150.....	45
1154.....	46
1155.....	45
1156.....	46
1160.....	197
1161.....	30
1162.....	33
1163.....	155
1165.....	32
1166.....	213
1167.....	34
1168.....	34
1169.....	27
1170.....	11
1171.....	12
1172.....	32
1176.....	25
1177.....	28
1178.....	25
1179.....	32
1180.....	196
1181.....	33
1183.....	27
1185.....	26
1186.....	30
1187.....	26
1188.....	27
1189.....	30
1192.....	28
1193.....	10
1196.....	9

CODE	PAGE
12	
1201.....	13
1202.....	14
1203.....	13
1204.....	13
1205.....	14
1207.....	18
1208.....	19
1210.....	19
1214.....	20
1215.....	20
1217.....	15
1223.....	15
1224.....	16
1233.....	14
1236.....	18
1238.....	15
1240.....	38
1243.....	39
1244.....	40
1247.....	38
1248.....	39
1249.....	38
1250.....	47
1253.....	48
1267.....	196
1275.....	211
13	
1311.....	13
1312.....	13
1351.....	47
15	
1520.....	24
1524.....	29
1525.....	29
1526.....	22
1527.....	31
1528.....	31
1529.....	33
1530.....	24
21	
2103.....	113
2104.....	113
2108.....	115
2109.....	115
2112.....	112
2113.....	114
2114.....	116
2115.....	114
2116.....	112
2117.....	117
2118.....	116
2121.....	146
2122.....	101
2124.....	81
2127.....	102
2128.....	103
2131.....	147
2132.....	148
2133.....	110

CODE	PAGE
2134.....	111
2140.....	109
2141.....	43
2142.....	41
2143.....	43
2151.....	147
2152.....	102
2163.....	155
2164.....	155
2166.....	154
2167.....	154
2168.....	156
2170.....	334
2171.....	180
2172.....	182
2174.....	180
2175.....	334
2176.....	180
2179.....	334
2183.....	107
2184.....	153
2186.....	153
2187.....	154
22	
2222.....	146
2275.....	187
2276.....	211
2278.....	212
23	
2301.....	121
2302.....	124
2308.....	122
2309.....	125
2310.....	124
2311.....	121
2313.....	121
2314.....	122
2316.....	125
2318.....	124
2321.....	146
2322.....	101
2324.....	123
2328.....	123
2332.....	148
2333.....	147
2341.....	42
2342.....	42
2343.....	41
2344.....	320
2357.....	123
2361.....	151
2363.....	151
2364.....	149
2365.....	150
2366.....	149
2367.....	151
2372.....	182
2373.....	182
2374.....	181
2380.....	132
2381.....	132
2383.....	133

CODE	PAGE
2385.....	234
2386.....	133
2391.....	134
2394.....	238
2395.....	105
2396.....	136
2397.....	238
2398.....	132
2399.....	133
24	
2421.....	94
2422.....	97
2423.....	97
2424.....	98
2425.....	96
2426.....	93
2427.....	95
2428.....	98
2429.....	96
2430.....	108
2432.....	99
2433.....	100
2480.....	134
2491.....	92
25	
2501.....	115
27	
2724.....	103
28	
2801.....	122
2824.....	103
2827.....	102
2828.....	103
2830.....	118
2841.....	156
2843.....	320
2844.....	319
2852.....	102
2862.....	152
2863.....	152
2866.....	152
2871.....	148
2872.....	149
2873.....	150
2874.....	156
2875.....	150
2876.....	151
2880.....	130
2881.....	117
2882.....	120
2885.....	120
2886.....	118
2887.....	118
2888.....	119
2889.....	120
2890.....	117
2891.....	118
2892.....	119
2893.....	119
2894.....	119

CODE	PAGE
2895.....	131
2896.....	131
2897.....	130
2898.....	132
2899.....	131
29	
2921.....	99
2941.....	105
2942.....	105
2943.....	197
2944.....	197
31	
3101.....	53
3102.....	55
3108.....	54
3109.....	54
3127.....	83~84
3128.....	85
32	
3202.....	57
3203.....	56
3205.....	58
3206.....	59
3208.....	55
3209.....	57
3210.....	58
3220.....	85
3221.....	88
3222.....	88
3224.....	89
3225.....	88
3226.....	91
3227.....	82~83
3228.....	85
3229.....	87
3230.....	64
3232.....	65
3233.....	66
3235.....	60
3236.....	57
3238.....	73
3239.....	69
3240.....	44
3241.....	44
3260.....	68
3261.....	67
3262.....	70
3263.....	74
3264.....	74
3266.....	66
3280.....	71
3281.....	63
3282.....	72
3285.....	74
3287.....	61
3288.....	68
3290.....	70
3291.....	63
3292.....	74
3293.....	75
3294.....	72

CODE	PAGE
3296.....	61
33	
3331.....	60
3332.....	60
3333.....	49
3334.....	153
3335.....	152
34	
3400.....	55
35	
3506.....	59
3520.....	86
3521.....	87
3530.....	65
3532.....	65
3533.....	67
3538.....	73
3539.....	69
3540.....	44
3560.....	68
3561.....	67
3562.....	70
3566.....	66
3580.....	72
3581.....	63
3588.....	69
3590.....	71
3591.....	64
3594.....	73
36	
3633.....	50
3634.....	90
3635.....	89
3636.....	52
3637.....	86
3638.....	90
3639.....	50
3640.....	86
3641.....	91
3661.....	49
40	
4001.....	165
4002.....	167
4003.....	225
4004.....	225
41	
4100.....	160
4101.....	161
4105.....	158
4106.....	159
4107.....	163
4108.....	162
4110.....	167
4111.....	157
4118.....	168
4120.....	174
4121.....	179
4124.....	171

CODE	PAGE
4129.....	175~178
4130.....	171
4131.....	178
4139.....	172~173
4141.....	183
4142.....	184
4143.....	224
4144.....	184
4147.....	189
4155.....	226
4157.....	145
4164.....	162
4166.....	168
4168.....	179
4180.....	190
4184.....	75
42	
4206.....	106
4208.....	106
4209.....	106
46	
4601.....	191
4602.....	191
4605.....	191
4621.....	192
4622.....	192
4630.....	198
4653.....	92
47	
4700.....	189
4701.....	187
4702.....	189
4705.....	186
4706.....	188
4707.....	186
4710.....	183
4720.....	144
4721.....	145
4722.....	143
4723.....	144
4725.....	142
4726.....	143
4745.....	187
4747.....	187
4754.....	189
4760.....	188
4762.....	188
4770.....	183
4780.....	181
4782.....	144
4786.....	143
4788.....	145
4789.....	142
4790.....	184
4791.....	185
4792.....	185
4793.....	185
4794.....	185
4795.....	186
4797.....	181
4799.....	181

CODE	PAGE
48	
4801.....	195
4802.....	195
4804.....	195
4806.....	195
4807.....	194
4810.....	194
4812.....	194
4820.....	193
4824.....	193
4830.....	199
4831.....	199
4832.....	200
4833.....	198
4834.....	200
4835.....	202
4836.....	200
4837.....	198
4838.....	202
4839.....	205
4840.....	204
4841.....	204
4842.....	206
4843.....	206
4844.....	196
4845.....	320
4846.....	203
4847.....	201
4848.....	201
4849.....	203
4850.....	203
4851.....	204
4852.....	199
4860.....	192
49	
4902.....	335
4903.....	336
4904.....	336
4905.....	335
4906.....	335
4907.....	336
4908.....	336
4910.....	337
4911.....	337
4912.....	338
4913.....	338
4914.....	338
4917.....	339
4918.....	339
50	
5013.....	217
5021.....	214
5022.....	214
5023.....	214
5024.....	214
5031.....	215
5041.....	215
5042.....	215
5051.....	215
5052.....	216
5061.....	216



CODE	PAGE
5062.....	216
5063.....	217
5064.....	205
5071.....	206
5072.....	206
5091.....	217
51	
5101-M500.....	281
5101-M500BD.....	281
5102-M600.....	283
5102-M600BD.....	283
5103-M1000.....	284
5103-M1000BD.....	284
5104-M700.....	282
53	
5301-D400.....	268
5302-AF105.....	266
5303-AF103.....	267
5305-ZS80.....	288
5307-ID100.....	272
61	
6140.....	16
6141.....	39
6143.....	26
6144.....	16
62	
6200.....	137
6201.....	137
6202.....	137
6207.....	139
6208.....	136
6210.....	137
6211.....	139
6212.....	139
6214.....	138
6215.....	138
6217.....	138
6224.....	139
6272.....	138
6282.....	126~128
6284.....	134
6291.....	135
6293.....	135
6294.....	234
6295.....	234
6296.....	135
6297.....	135
6298.....	134
63	
6300.....	77
6301.....	76
6307.....	76
6310.....	77
6312.....	170
6315.....	75
6353.....	77
6354.....	77
6372.....	78
6373.....	78

CODE	PAGE
6375.....	80
6377.....	80
6381.....	79
6384.....	78
6385.....	78
6386.....	79
6387.....	79
6388.....	80
65	
6521.....	228
6522.....	227
6523.....	227
6524.....	228
6525.....	229
6526.....	229
6527.....	227
6528.....	228
6533.....	224
6534.....	224
6535.....	225
6547.....	226
6548.....	226
6549.....	226
6550.....	237
6553.....	237
6554.....	237
6555.....	238
6556.....	237
6562.....	236
6566.....	235
6567.....	236
6568.....	236
6571.....	235
6572.....	235
6573.....	236
6582.....	230
6583.....	233
6584.....	231
6585.....	232
6586.....	229
6587.....	232
6588.....	233
68	
6801.....	223
6802.....	220
6803.....	220
6804.....	220
6832.....	201
6862.....	141
6863.....	140
6864.....	141
6865.....	141
6866.....	140
6867.....	140
6881.....	164
6883.....	163
6884.....	166
6886.....	163
6887.....	221
6888.....	221
6889.....	222
6890.....	222

CODE	PAGE
6891.....	223
6892.....	223
6894.....	225
6896.....	219
6897.....	221
6898.....	219
6899.....	224
69	
6900.....	218
6902.....	218
6903.....	219
6990.....	213
71	
7101.....	239
7102.....	239
7106.....	242
7107.....	243
7110.....	210
7111.....	211
7113.....	210
7114.....	108
7115.....	109
7116.....	109
7117.....	190
7118.....	190
7119.....	210
7120.....	211
7123.....	210
7125.....	108
7140.....	208
7142.....	208
7143.....	209
7144.....	209
7145.....	209
7150.....	48
7160.....	298
7161.....	299
7162.....	299
7163.....	299
7164.....	300
72	
7202.....	212
7203.....	213
7205.....	212
7230.....	213
7231.....	213
7232.....	213
7240.....	207
7241.....	207
7247.....	208
7260.....	208
7261.....	207
7262.....	207
73	
7302.....	4
7302-ADD□□□.....	5
7302-HUB□□□.....	5
7304.....	5
7305.....	6
7309-B01M.....	244

CODE	PAGE
7309-C01M.....	245
7315.....	3
7316.....	2
7318.....	1
7321.....	91
7330.....	129
7331.....	130
7332.....	128
7340.....	169
7341.....	169
7350.....	104
7351.....	104
7352.....	100
7353.....	104
7381.....	62
7382.....	62
7383.....	52
7384.....	51
7385.....	51
7391.....	64
75	
7511.....	296
7512.....	298
7513.....	297
7514.....	296
7515.....	296
7516.....	296
7517.....	295
7518.....	297
7519.....	297
7520.....	295
7521.....	295
7522.....	297
7523.....	298
76	
7600.....	333
80	
8001.....	379
8002.....	378
81	
8101.....	379
82	
8201.....	380
8202.....	380
83	
8301.....	378
84	
8401.....	381
85	
8501.....	381
89	
8910.....	383
8911.....	382
91	

CODE	PAGE
9120.....	323
9130.....	325
9131.....	324
92	
9221.....	327
9222.....	327
9241.....	328
9242.....	329
9243.....	329
93	
9331.....	326
9341.....	326
9351.....	327
95	
9501.....	318
9561.....	323
96	
9631.....	353
97	
9710.....	331
9720.....	328
CMM	
CMM-MN432.....	246~247
HDT	
HDT-L410.....	358
HDT-L411.....	359
HDT-LP200.....	357
HDT-RSR100.....	346
HDT-RW160.....	346
ISD	
ISD-V150A.....	261~262
ISD-V220CNCA.....	262~263
ISD-V250A.....	261~262
ISD-V270CNCA.....	262~263
ISD-V300A.....	261~262
ISD-V370CNCA.....	262~263
ISD-V400A.....	261~262
ISD-VMM□□□.....	264~265
ISE	
ISE-2DT.....	333
ISF	
ISF-1DF□□□.....	368
ISF-DF□□□.....	367
ISF-F□□□.....	368
ISF-MT1K.....	367
ISF-MT500.....	368
ISF-TG□□□.....	369
ISHB	
ISHB-B300.....	363
ISHB-C161.....	363
ISHB-D200.....	348
ISHB-D300.....	348
ISHB-H131.....	363

CODE	PAGE
ISHB-M100.....	349
ISHB-P101.....	362
ISHB-TSA.....	353
ISHB-TSB.....	353
ISH	
ISH-BRV.....	347
ISH-DSA.....	364
ISH-DSD.....	364
ISH-DS-STANDA.....	365
ISH-DV10.....	350
ISH-DV5.....	350
ISH-DV50.....	350
ISH-MR150.....	345
ISH-MRD200.....	343
ISH-OS2.....	366
ISH-PHB.....	355
ISH-PH-SP9.....	360
ISH-R150.....	345
ISH-RD200.....	344
ISH-RSR400.....	341~342
ISH-RSR500.....	341~342
ISH-RSR600.....	341~342
ISH-S30A.....	365
ISH-S30A-BLOCK.....	365
ISH-S30D.....	365
ISH-S30D-BLOCK.....	365
ISH-SAM.....	366
ISH-SDM.....	366
ISH-SPHA.....	356
ISH-STAC.....	366
ISH-STD.....	366
ISH-TDV1000A.....	352
ISHR	
ISHR-B141.....	361
ISHR-D121.....	360
ISHR-M111.....	361
ISHR-P151.....	362
ISHR-T400.....	340~341
ISHR-T500.....	340~341
ISHR-T600.....	340~341
ISHU	
ISHU-330.....	354
ISHV	
ISHV-D120.....	351
ISHW	
ISHW-B□□□.....	364
ISHW-L□□□.....	364
ISL	
ISL-A1-□□□.....	240~241
ISL-A5-□□□.....	240~241
ISL-B5-□□□.....	240~241
ISL-DR2.....	241
ISL-DR3.....	241
ISM	
ISM-CM20.....	291~292
ISM-CM63.....	293~294
ISM-DL300.....	269~270

CODE	PAGE
ISM-DL301.....	269~270
ISM-DL302.....	271
ISM-DL400.....	273~274
ISM-DL-COAXIAL.....	276
ISM-DL-LED.....	275
ISM-DL-OB□□□.....	276
ISM-DL-STAGE1.....	275
ISM-MV10.....	294
ISM-PM100.....	295
ISM-PM160LA.....	277~278
ISM-PM20.....	295
ISM-PM200SA.....	277~278
ISM-PM200SB.....	277~278
ISM-PM40.....	295
ISM-PM50.....	295
ISM-PM600SA.....	277~278
ISM-POL1000.....	289
ISM-TV200.....	278
ISM-TV200W.....	278
ISM-WF200.....	279~280
ISM-ZS100.....	286
ISM-ZS100T.....	286
ISM-ZS200.....	285
ISM-ZS30.....	288
ISM-ZS50.....	287
ISM-ZS50T.....	287
ISM-ZS70-S.....	290
ISM-ZS-LED.....	275
ISO	
ISO-2000FN.....	317
ISP	
ISP-A1000E.....	253~254
ISP-A3000E.....	257~258
ISP-A5000E.....	255~256
ISP-A7000E.....	259~260
ISP-AZ3020.....	255~256
ISP-W3020.....	257~258
ISP-W4025.....	259~260
ISP-Z3015.....	253~254
ISQ	
ISQ-DG6.....	330
ISQ-DG8.....	330
ISQ-PK100.....	319
ISQ-RA600.....	107
ISQ-RM30.....	332
ISQ-TS120K.....	332
ISR	
ISR-C002.....	310
ISR-C003.....	315
ISR-C300.....	313~314
ISR-CS017.....	316
ISR-CS018.....	316
ISR-CS130-W.....	316
ISR-CS□□□.....	315
ISR-RS□□□.....	316
ISR-S400.....	311~312
IST	
IST-11WM□□□.....	374
IST-12W□□□.....	373

CODE	PAGE
IST-5W□□□.....	376
IST-9WM□□□.....	375
IST-DCT□□□.....	371
IST-DTT1.....	370
IST-DTT10.....	370
IST-DTT5.....	370
IST-DW□□□.....	376
IST-PW□□□.....	375
IST-SD200.....	371
IST-SD400.....	371
IST-SD50.....	371
IST-TM□□□.....	377
IST-TS500.....	370
IST-TT□□□.....	369
IST-WP12.....	371
IST-WP20.....	371
IST-WP6.....	371
IST-WS□□□.....	372
IST-W□□□.....	372
ISU	
ISU-100D.....	322
ISU-250C.....	322
ISU-300D.....	321
ISV	
ISV-1HLED.....	309
ISV-1H□□□.....	308
ISV-1LED1.....	309
ISV-2000DS.....	304
ISV-2001DS.....	304
ISV-2002DS.....	304
ISV-2CAM.....	309
ISV-3000DS.....	304
ISV-3001DS.....	304
ISV-3002DS.....	304
ISV-4000DS.....	304
ISV-E10.....	307
ISV-E20.....	308
ISV-MS724.....	303
ISV-MS726.....	303
ISV-MSU.....	300~302
ISV-RV.....	307
ISY	
ISY-100.....	247~248
LDM	
LDM-030.....	251
LDM-065.....	251
MLP	
MLP-CM60.....	384
MLP-GP260.....	385
MLP-MP30.....	384
SPM	
SPM-1000.....	249~250
TLP	
TLP-P340.....	252
VSP	
VSP-201.....	305~306

APPLICATION INDEX OF MEASURING TOOLS

SHAFT DIAMETER



Dial Snap Gages
2186-
(page 153)



Adjustable Snap Gages
2187-
(page 154)



Indicating Micrometers
3333- (page 491)
3332- (page 60)



Micrometers With Dial Indicator
3296-, 3331- (page 60-61)
3633- (page 50)



Dial Snap Gages
3335-, 3334-
(page 152-153)



Outside Micrometers
(page 53-59)



Universal Caliper
1125-
(page 21)

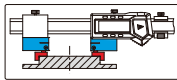

Digital/Dial/Vernier Calipers
(page 7-20)



External Caliper Gages
2333-, 2332-, 2132-
(page 147-148)



Circumference Tapes
7114-, 7116-, 7115-
(page 108-109)



EXTERNAL GROOVE DIAMETER



Digital Blade Calipers
1188-
(page 27)

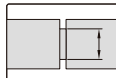

Blade Micrometers
3232-, 3532-
(page 65)

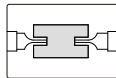

Digital Outside Neck Calipers
1187-
(page 26)

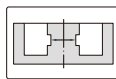

Digital Calipers With Interchangeable Points
1526-, 1124-, 1530-
(page 22-24)

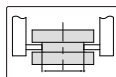

Universal Caliper
1125-
(page 21)

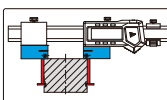

External Caliper Gages
2333-, 2332-, 2132-
(page 147-148)



Outside Calipers
7262-, 7241-
(page 207)



ARC RADIUS

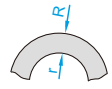

Large Diameter Gage
ISQ-RA600 (page 107)



Digital Radius Gage
2183
(page 107)

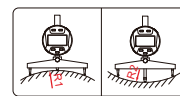

Digital Arc Radius Calipers
1189- (page 30)

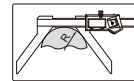

Radius Gages
4801-, 4804-
(page 195)



BORE DIAMETER

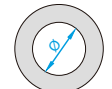

Digital/Dial/Vernier Calipers With Internal Measuring Jaws
(page 7-20)



Universal Caliper
1125-
(page 21)

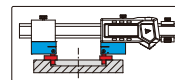

Digital Inside Knife-edge Calipers
1123-
(page 28)

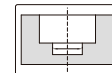

Inside Micrometers
3220-, 3520-
(page 85-86)



Three Points Internal Micrometers
3227-, 3127-, 3228-, 3128-
(page 82-85)



Pistol Grip Three Points Bore Gages
2124-
(page 81)



Tubular Inside Micrometers
(page 87-90)



Bore Plug Gages
4653-
(page 92)



APPLICATION INDEX OF MEASURING TOOLS

Split Type Dial Bore Gages
(page 92-96)



Accessory Set For Digital Calipers
6144- (page 16)



Bore Gages
(page 97-104)



Internal Caliper Gage
2222-, 2321-, 2151-
(page 146-147)



Telescoping Gages
4208-, 4206-, 4209-
(page 106)



Internal Groove Bore Gage
2433-
(page 100)



Inside Spring Calipers
7261-, 7240-
(page 207)



Internal Caliper Gages
2222-, 2321-, 2151-
(page 146-147)



WIDTH AND POSITION OF GROOVE INSIDE HOLE

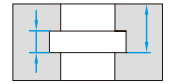

Taper Bore Gages
4852-
(page 199)



Digital Hook Calipers
1122-
(page 29)



Pin Gages
4166-, 4110-, 4118-
(page 167-168)



Depth Gages With Hook
1142-, 1144-
(page 35-36)
1248- (page 39)

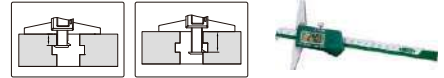

Plain Plug Gages
4124- (page 171)



**Digital Depth Gages With Round
Depth Bar**
1148-
(page 37)

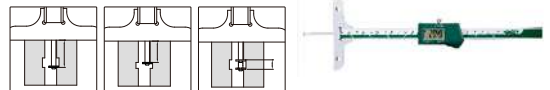

Taper Gages
4833-, 4837-
(page 198)



Groove Micrometers
3287- (page 61)

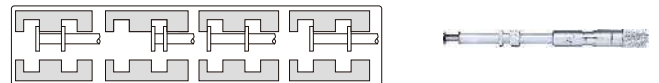

Tape Bore Gages
2430-
(page 108)



Internal Circumference Tapes
7125-
(page 108)



DIAMETER OF GROOVE INSIDE HOLE

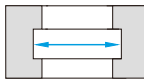

DIAMETER OF BORE WITH CHAMFER

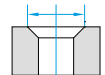

Universal Caliper
1125-
(page 21)



Internal Chamfer Gages
2941-, 2942-
(page 105)

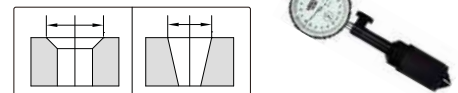

CHAMFER

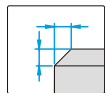

**Digital Calipers With Interchangeable
Points**
1526-, 1124-, 1530-
(page 22-24)



Chamfer Gages
4844-, 1180-, 1267-
(page 196)



Digital Inside Groove Calipers
1120-, 1121-, 1176-, 1178-, 1520-
(page 24-25)



Chamfer Height Gages
2943-, 2944-
(page 197)



APPLICATION INDEX OF MEASURING TOOLS

TUBE WALL THICKNESS

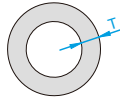

Ultrasonic Thickness Gages
ISU-300D, ISU-250C, ISU-100D
(page 321-322)



Digital Tube Thickness Calipers
1161- (page 30)

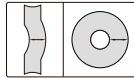

Cylindrical Anvil Tube Micrometers
3261-, 3561-
(page 67)

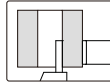

Spherical Anvil Tube Micrometers
3260-, 3560-
(page 68)



Tube Thickness Gages
2876-, 2367-
(page 151)

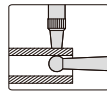

Digital Tube Thickness Gages
2873-
(page 150)

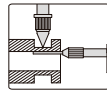

HEIGHT

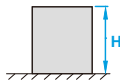

Digital High Precision Height Gages
1155-
(page 45)



Height Gages
(page 45-48)



Dial Indicator Stands
6866-, 6867-, 6863-, 6864-, 6862-
(page 140-141)



Transfer Stand
6865-
(page 141)



Mini Digital Height Gages
1146-
(page 48)



DEPTH



Depth Gages
1149-, 1141-, 1147- (page 34-36)
1240-, 1247-, 1249- (page 38)



Depth Gages With Point
1143-
(page 36)

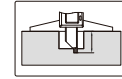

Depth Gages With Hook
1142-, 1144-
(page 35-36)
1248- (page 39)

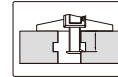
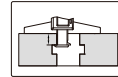

Digital Depth Gages With Round Depth Bar
1148- (page 37)

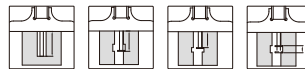

Mini Depth Gages
1244-, 1145-, 1140-
(page 40)



Dial/Digital Depth Gages
2343-, 2142-, 2341-, 2342-, 2141-
(page 41-43)



Depth Micrometers
3540-, 3240-, 3241-
(page 44)



Digital/Dial/Vernier Calipers With Depth Bar
(page 7-16)



THICKNESS



Thickness Gages
(page 148-152)



Digital Snap Gages
2166-, 2167-, 2163-, 1163-
(page 154-155)



External Caliper Gages
2333-, 2332-, 2132-
(page 147-148)



APPLICATION INDEX OF MEASURING TOOLS

WIDTH



Caliper Type Micrometers
3238-, 3538-
(page 73)



Disk Micrometers
3294-, 3594-, 3282-
(page 72-73)



SLOT WIDTH



Taper Gages
4833-, 4837-
(page 198)



Taper Slot Gages
1160-, 4630-
(page 197-198)



Internal Caliper Gages
2222-, 2321-, 2151-
(page 146-147)



Feeler Gages
4601-, 4602-, 4605-
(page 191)



Step And Gap Gage
2168-
(page 156)

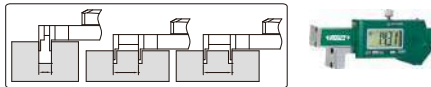

Groove Micrometers
3287- (page 61)

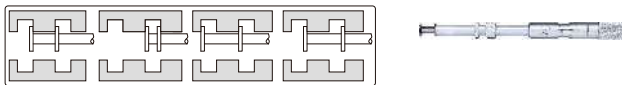

HOLE CENTER-TO-CENTER AND CENTER-TO-EDGE DISTANCE

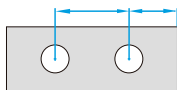

Digital Centering Calipers
1192-, 1177-, 1525-,
1524- (page 28-29)



Universal Caliper
1125-
(page 21)



Accessory Set For Digital Calipers
6144-
(page 16)



ANGLE

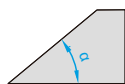

Protractors
(page 180-181)



Protractors
2374-, 2372-, 2373-, 2172-
(page 181-182)



Squares
4745-, 4747-, 4760-, 4762-, 4706-, 4754-
(page 187-189)



Angle Gages
4806-, 4807
(page 194-195)



Angle Gage Blocks
4002-
(page 167)



Digital Level And Slope Meters
2175-, 2179-, 2170-
(page 334)

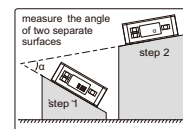

STRAIGHTNESS AND FLATNESS

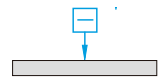

Straight Edges
4700-, 4147-, 4180-,
7117-, 7118-
(page 189-190)



SQUARENESS

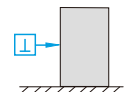

Squares
4141-, 4144-, 4710-
(page 183-184)



Granite Squares With V Groove
4142-
(page 184)



Perpendicularity Testers
4770-
(page 183)



Squares
(page 184-187)



COAXIALITY AND RUNOUT

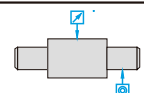

Concentricity Gages
(page 142-143)



APPLICATION INDEX OF MEASURING TOOLS

Bench Centers
(page 143-145)



Digital Calipers With Interchangeable Points
1526-, 1124-
(page 22-23)



V-blocks
(page 219-221)



Gear Tooth Pitch Gages
4860-
(page 192)



Magnetic V-blocks
(page 222-224)



THREAD

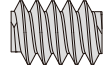

DIAMETER OF CUTTING TOOLS WITH ODD FLUTES



3-wires
7382-
(page 62)

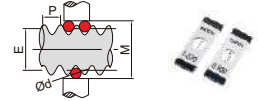

Digital V Type Calipers
1529-
(page 33)



External Screw Thread Micrometers
3639- (page 50)
3281-, 3581- (page 63)

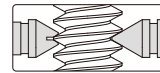

V-Anvil Micrometers
3290-, 3590-
(page 70-71)



Internal Screw Thread Micrometers
3640- (page 86)

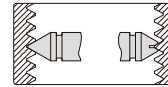

GEAR AND SPLINE



Digital Gear Tooth Calipers
1181-
(page 33)

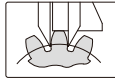

Internal Screw Thread Micrometers
3641-, 3226- (page 91)

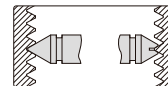

Thread Plug Gages
(page 171-178)



Disk Micrometers
3282-, 3294-, 3594-
(page 72-73)

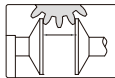

Thread Ring Gages
(page 174-179)



External Gear Tooth Micrometers
3636- (page 52)
3291-, 3591- (page 63-64)

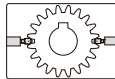

Pitch Gages
4824-, 4820-
(page 193)



Internal Gear Tooth Micrometers
3637-
(page 86)



Universal Caliper
1125-
(page 21)

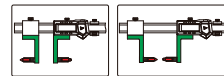

Internal Gear Tooth Micrometers
3638-
(page 90)



Digital Calipers With Interchangeable Points
1526-, 1124-
(page 22-23)

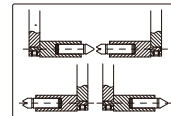

Gear Bore Gages
2428-
(page 98)



Universal Caliper
1125-
(page 21)

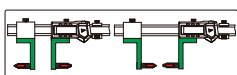



NOFERMAQ SpA

SANTA ROSA # 1581
SANTIAGO - CHILE
FONO: 2 2554 5716

MIGUEL DE ATERO # 2742 QUINTA NORMAL
SANTIAGO - CHILE
FONO: 22 554 5845



www.insize.com

**Application index of
measuring tools
(page 390-394)**



Distributed by:

